

FOREVER

Master Collection Bathroom

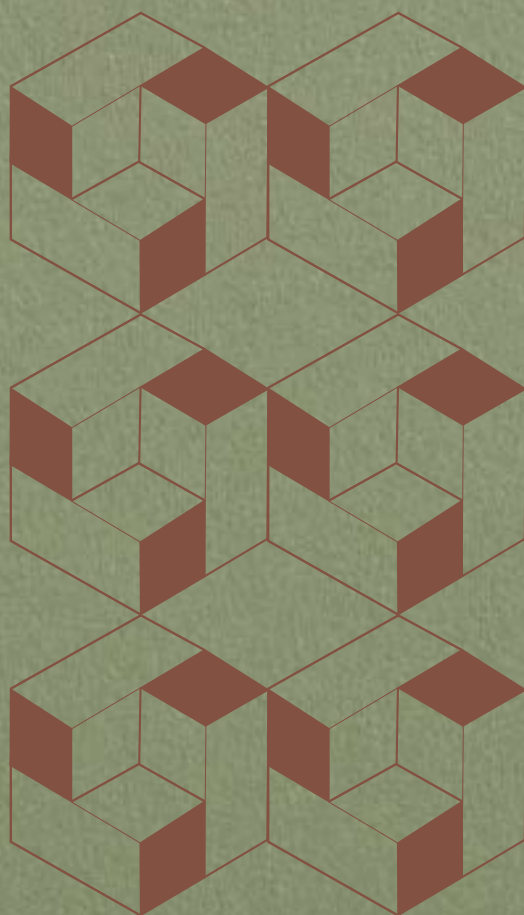

Forever Collection

Master Bathroom Collection



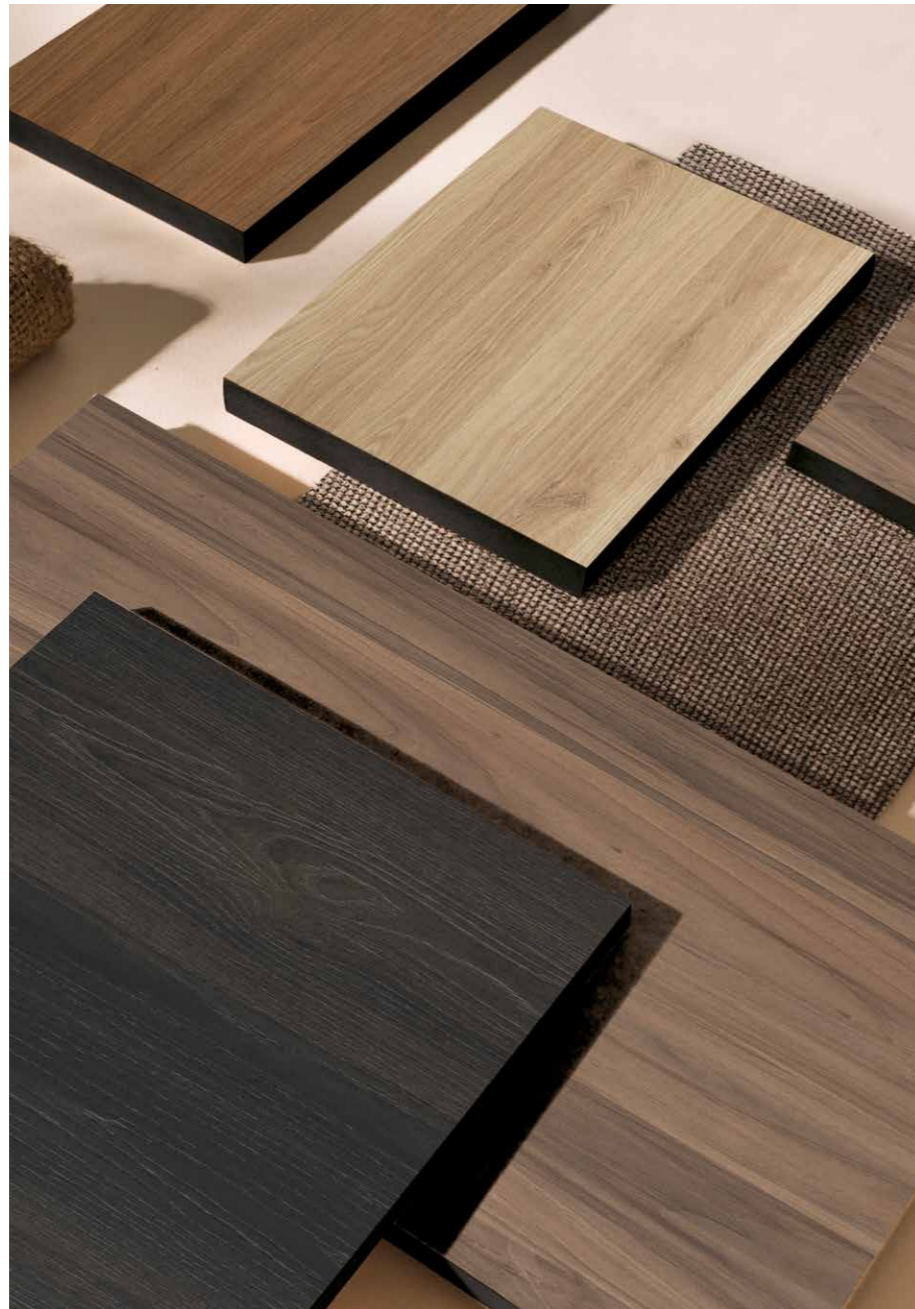

OASIS is an Italian entrepreneurial family story that starts in 1908 from a small workshop. Today we are an industrial company with a global exposure but with deep roots in the Italian high-end furniture tradition. The goal of our fourth generation is to bring traditional Italian design and quality to a refined cosmopolitan consumer who is looking for a tailor-made service.

OASIS è una storia familiare imprenditoriale italiana che inizia nel 1908 da un laboratorio di falegnameria. Oggi siamo un'azienda industriale con un'esposizione globale, ma con radici profonde nella tradizione italiana dell'arredamento di alta gamma. L'obiettivo della quarta generazione è portare il design e la qualità della tradizione italiana a un consumatore raffinato e cosmopolita che cerca un servizio su misura.

Timeless elegance, craftsmanship
and quality. These are the distinctive
features of our products.

Eleganza senza tempo, artigianalità e qualità.
Queste sono le caratteristiche distintive dei nostri prodotti.





Forever Collection

Master Bathroom Collection

FOREVER_001

ASH OAK - TORTORA ELEGANCE

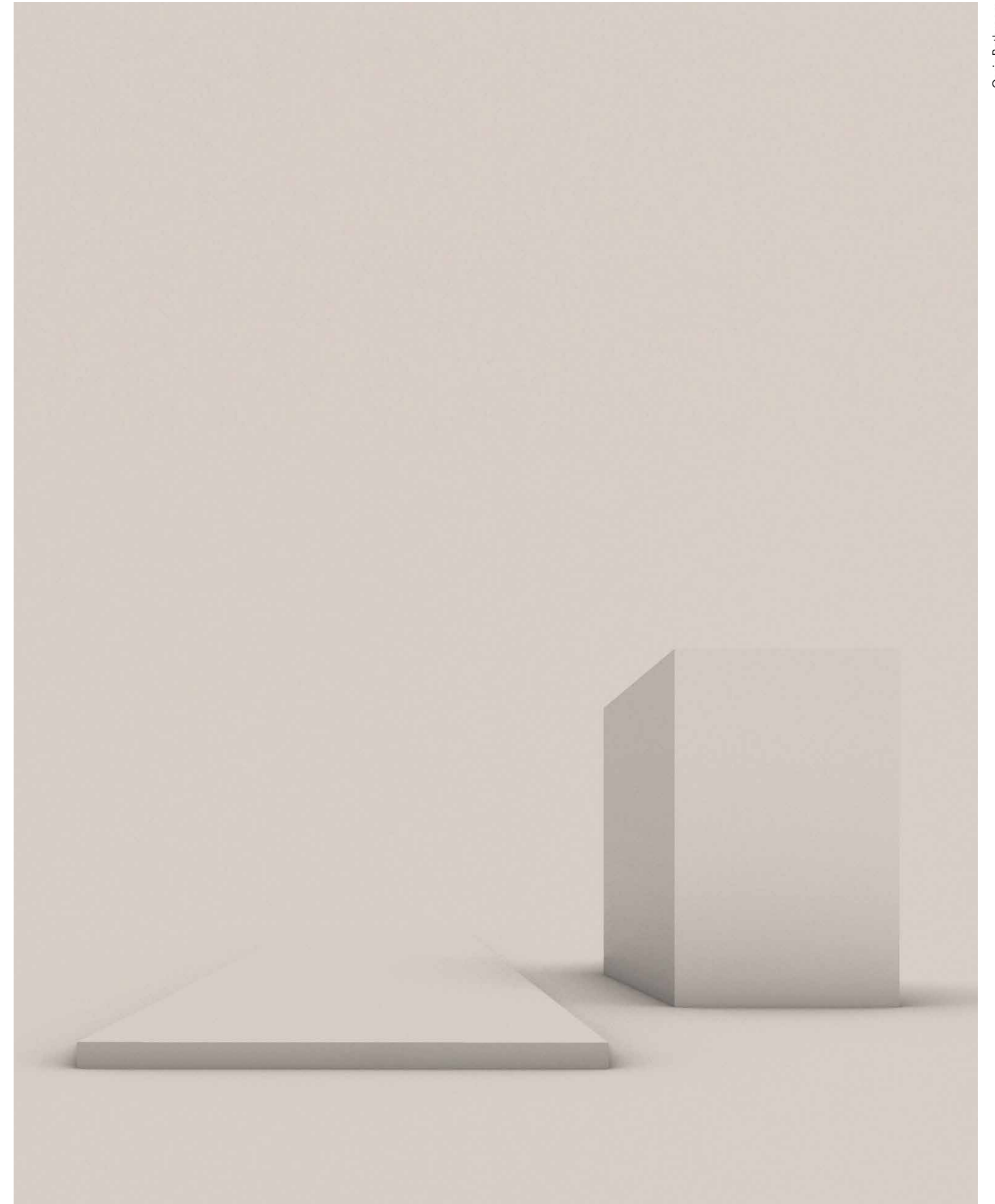





The AMY countertop washbasin in glossy white ceramic harmonises with the VOLCANO bathtub in matt Tortora Elegance Lightfeel, alongside MAX and CUBE wall-hung tall units and RIGA boiserie. All the countertop basins in Solid Surface are available in all the matt finishes of the colour sample: in fact the two VOLCANO washbasins shown on the variation are in Tortora Elegance coloured lightfeel.

In questa composizione, il lavabo AMY in ceramica bianca lucida è abbinato alla vasca VOLCANO in finitura lightfeel opaco Tortora Elegance e alle colonne MAX, CUBE e alle boiserie RIGA. L'intera selezione dei lavabi in appoggio in solid surface è disponibile in tutte le finiture opache della mazzetta colori: la variante con i due lavabi VOLCANO sono infatti proposti in finitura lightfeel colore tortora elegance







**Composition FO_001**

Structure:
W 35 + 90 + 90 + 35 cm
D 51 cm
H 30 + 1,2 cm
N0003 Ash Oak melamine wood finish

Handles:
Matt black

Top:
Matt white Purefeel

Amy washbasin:
Glossy white ceramic

Stilo basin mixer:
Brushed black

Easy mirror:
W 180 cm – H 80 cm

Lume lamps:
Matt black

Riga boiserie:
Pannelli in Tortora Elegance lacquered finish, shelves in brushed black aluminium H 196 cm

Cube wall-hung tall units:
N0003 Ash Oak melamine wood
Holy handles in matt black

Max wall-hung tall units:
N0003 Ash Oak melamine wood

Volcano bathtub:
Matt Tortora elegance Lightfeel

Freestanding bath mixer:
Brushed black

Line bar and accessories:
Brushed black

_Complements
Medea side tables

_Variation shown
Top and upstand for top:
Matt Tortora elegance Purefeel

Volcano washbasin:
Matt Tortora elegance Lightfeel

Paris Square mirror:
W 180 cm – H 80 cm

Composizione FO_001

Struttura:
W 35 + 90 + 90 + 35 cm
D 51 cm
H 30 + 1,2 cm
Nobilitato N0003 Ash Oak

Maniglie:
Nero opaco

Top:
Purefeel colore bianco opaco

Lavabo Amy:
Ceramica bianco lucido

Miscelatore lavabo Stilo:
Nero spazzolato

Specchio Easy:
W 180 cm – H 80 cm

Lampade Lume:
Nero opaco

Boiserie Riga:
Pannelli laccati tortora elegance, mensole in alluminio nero spazzolato H 196 cm

Colonne Cube:
Nobilitato N0003 Ash Oak
Maniglie Holy nero opaco

Colonne Max:
Nobilitato N0003 Ash Oak

Vasca Volcano:
Lightfeel colore tortora elegance opaco

Colonna miscelatore vasca da terra Stilo:
Nero spazzolato

Barra Line e accessori:
Nero spazzolato

_Complementi
Tavolini Medea

_Variante
Top e Alzata:
Purefeel colore tortora elegance opaco

Lavabo Volcano:
Lightfeel colore tortora elegance opaco

Specchio Paris square:
W 180 cm – H 80 cm

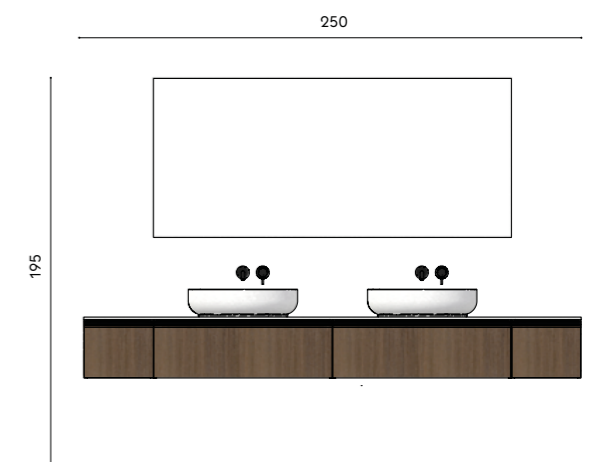

FOREVER_002

PURE WHITE - NATURAL OAK

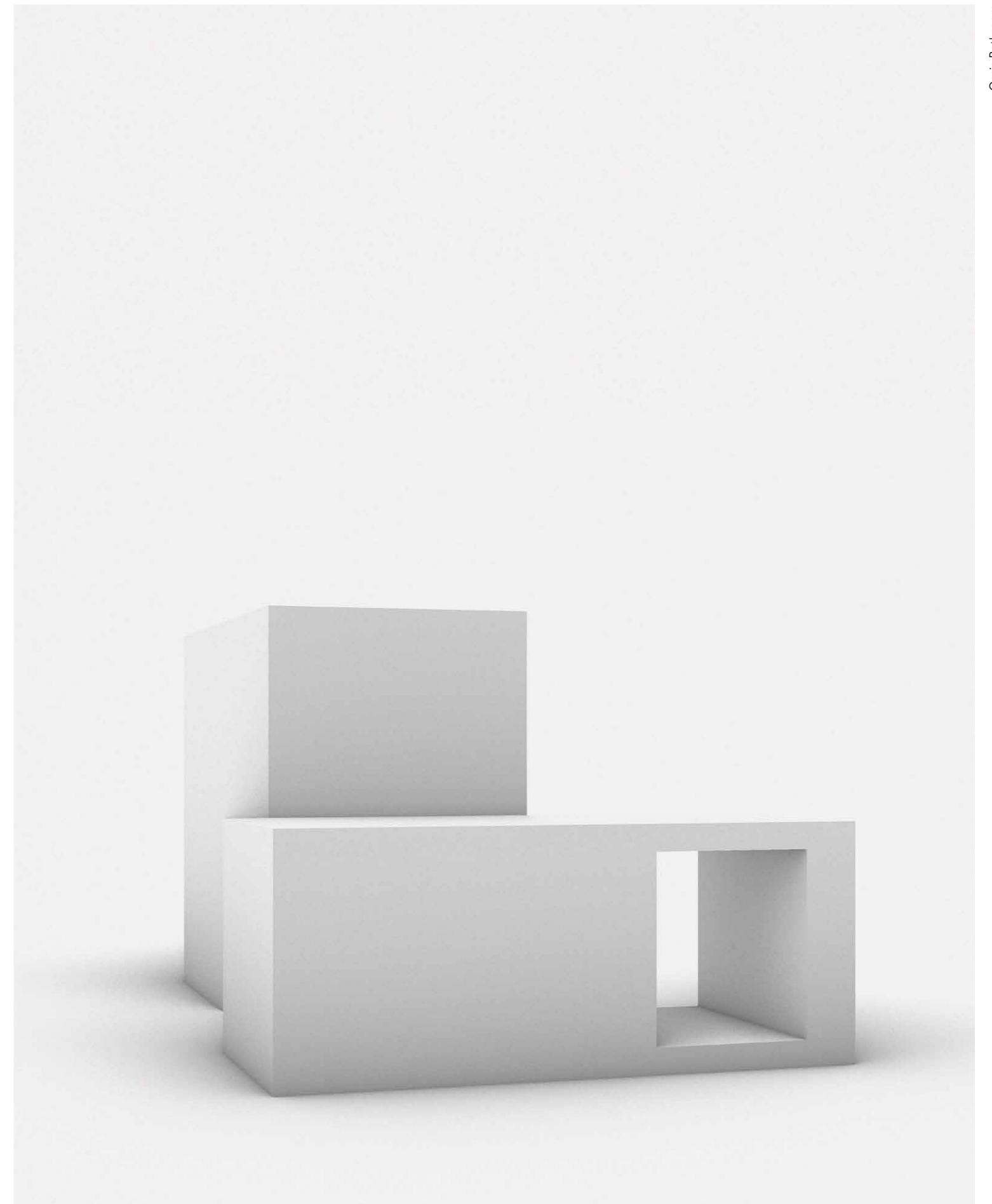





The open shelf wall unit in Natural Oak melamine wood contrasts with the white finishes of the entire composition and is illuminated by the LED light positioned behind the central shelf. Other elements are the LUME suspended lamp and the wall-hung tall unit in smoked glass, 15 cm depth.

Il vano a giorno in finitura Nobilitato Natural Oak contrasta le finiture bianche dell'intera composizione, ed è illuminato da un led posizionato dietro al ripiano centrale. Ulteriori elementi sono la lampada nera opaca LUME a soffitto e il pensile a giorno in vetro fumé profondo 15 cm.







**Composition FO_002**

Structure:
W 105 + 45 cm
D 51 cm
H 56 + 1,2 cm
N0005 Pure white Melamine wood

Handles:
Matt white

Top:
Matt white Lightfeel with Drop
integrated washbasin

**Wall-hung base unit with open shelves
and integrated Led lighting:**
N0001 Natural Oak Melamine wood

Stilo basin mixer:
Brushed steel

Dali Full mirror:
W 105 cm – H 80 cm

Open shelf wall unit:
Smoked glass Back in N0005 Pure white
melamine wood

Lume lamp:
Matt black

Sidney back-to-wall sanitary ware:
Matt white ceramic

Stilo bidet mixer:
Brushed steel

Defilè accessories:
Chrome

_Variation shown
Structure:
W 120 + 35 cm
D 51 cm
H 56 + 1,2 cm
N0011 Deep Dark melamine wood

Handles:
Matt black

Back of open shelf wall unit:
N0011 Deep Dark melamine wood

**Top: Nero Lavagna coloured glass with
Rose integrated washbasin**

Composizione FO_002

Struttura:
W 105 + 45 cm
D 51 cm
H 56 + 1,2 cm
Nobilitato N0005 Pure white

Maniglie:
Bianco opaco

Top:
Lightfeel bianco opaco con
vasca integrata Drop

Vano a giorno con luce led integrata:
Nobilitato N0001 Natural Oak

Miscelatore lavabo Stilo:
Acciaio spazzolato

Specchio Dali Full:
W 105 cm – H 80 cm

Pensile a giorno:
Vetro fumè
Schiena in Nobilitato N0005 Pure white

Lampada Lume:
Nero opaco

Sanitari Sidney a terra:
Ceramica bianca opaca

Miscelatore per bidet Stilo:
Acciaio spazzolato

Accessori Defilè:
Cromo

_Variante
Struttura:
W 120 + 35 cm
D 51 cm
H 56 + 1,2 cm
Nobilitato N0011 Deep Dark

Maniglie:
Nero opaco

Schiena pensile a giorno:
Nobilitato N0011 Deep Dark

Top:
Vetro laccato Nero Lavagna con
vasca integrata Rose

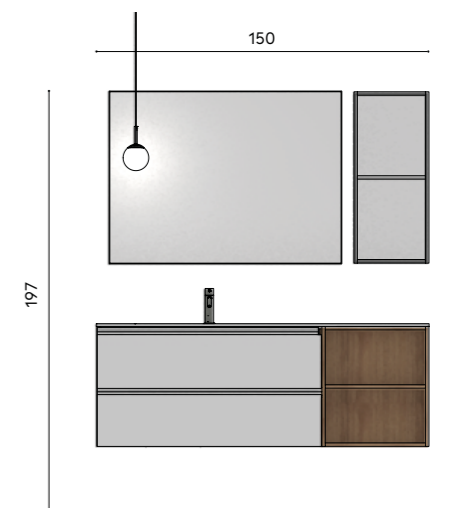

FOREVER_003

GRIGIO PIETRA - LAVA OAK

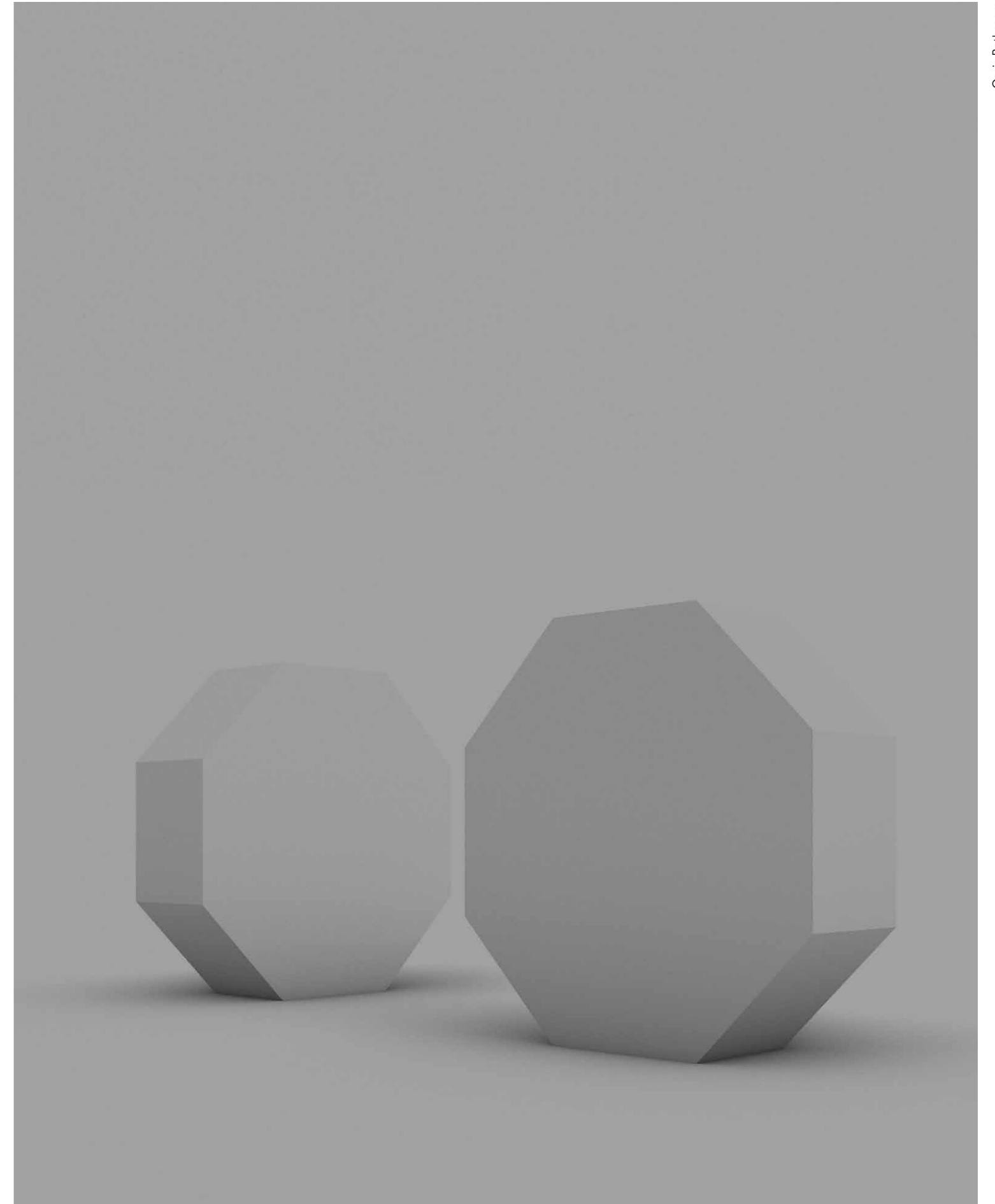





At the centre of the composition is a 12 cm high and 240 cm long top with NICK integrated washbasin in matt white Purefeel. The SEI lamps, 100 cm long in an exclusive bronze finish, illuminate and embellish the setting.

Al centro della composizione un top importante alto 12 cm e lungo 240 cm con vasca integrata NICK in Purefeel bianco opaco. Le lampade SEI lunghe 100 cm in finitura esclusivamente bronzata, illuminano ed impreziosiscono la composizione.







Composition FO_003

Top:
Matt white Purefeel with
Nick integrated washbasin
W 240 H 12 cm

Additional wall-hung base unit:
W 120 + 120 cm
D 51 cm
H 30 + 1,2 cm
Matt Grigio Pietra lacquered finish

Handles:
Matt black

Stilo basin mixer:
Brushed black

Jung mirror:
W 80 cm - H 80 cm

Sei lamp:
Bronze

Cube wall hung tall units:
N0004 Lava Oak melamine wood with
top in N0011 Deep Dark melamine wood
H 162 cm

Mizar bathtub:
Matt white Lightfeel

Freestanding bath mixer:
Brushed black

Defilè accessories:
Matt black

_Complements
Eros side tables

Composizione FO_003

Top:
Purefeel colore bianco opaco
con lavabo integrato Nick
W 240 H 12 cm

Basi complementari:
W 120 + 120 cm
D 51 cm
H 30 + 1,2 cm
Laccato opaco Grigio Pietra

Maniglie:
Nero opaco

Miscelatore lavabo Stilo:
Nero spazzolato

Specchi Jung:
W 80 cm - H 80 cm

Lampade Sei:
Bronzo

Colonne Cube:
Nobilitato N0004 Lava oak con
top Nobilitato N0011 Deep dark
H 162 cm

Vasca Mizar:
Lightfeel bianco opaco

Colonna miscelatore vasca da terra Stilo:
Nero spazzolato

Accessori Defilè:
Nero opaco

_Complementi
Tavolini Eros

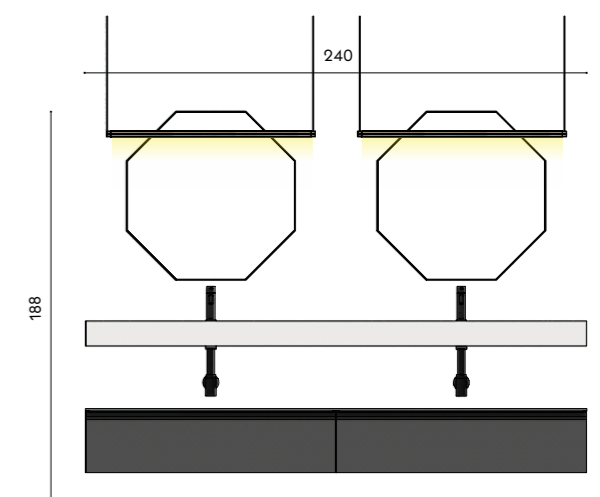

FOREVER_004

WHITE CHESTNUT - RUGGINE



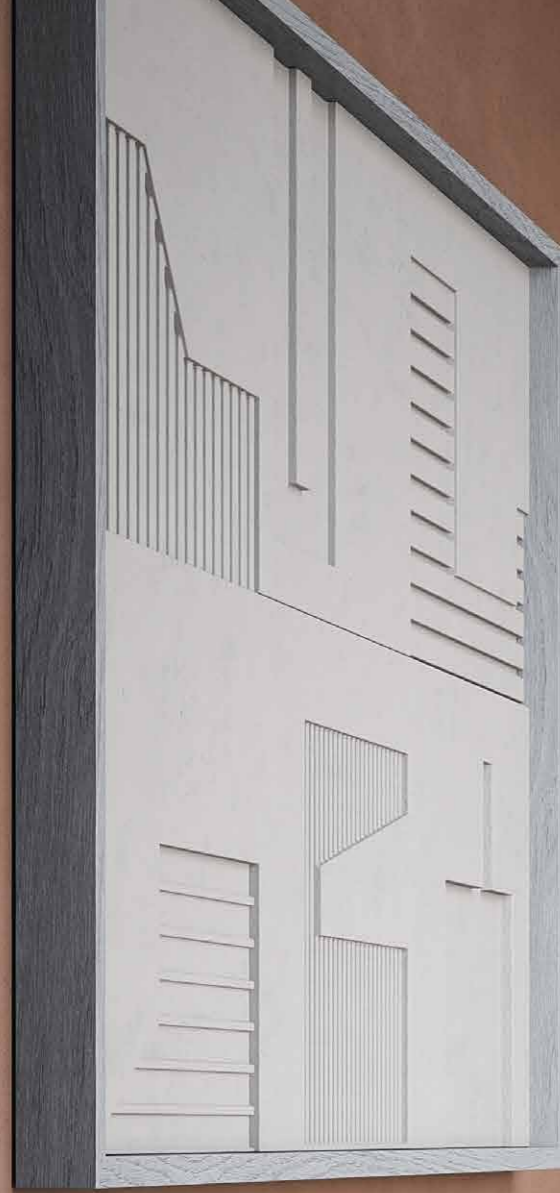



Of particular note is the White Chestnut top with a height of 6 cm combined with the AURORA countertop washbasin in matt white ceramic (H 20 cm).

Protagonista dell'ambiente è il top alto 6 cm impiallacciato White Chestnut con in appoggio il lavabo AURORA in ceramica bianca opaca, l'unico con altezza 20 cm.

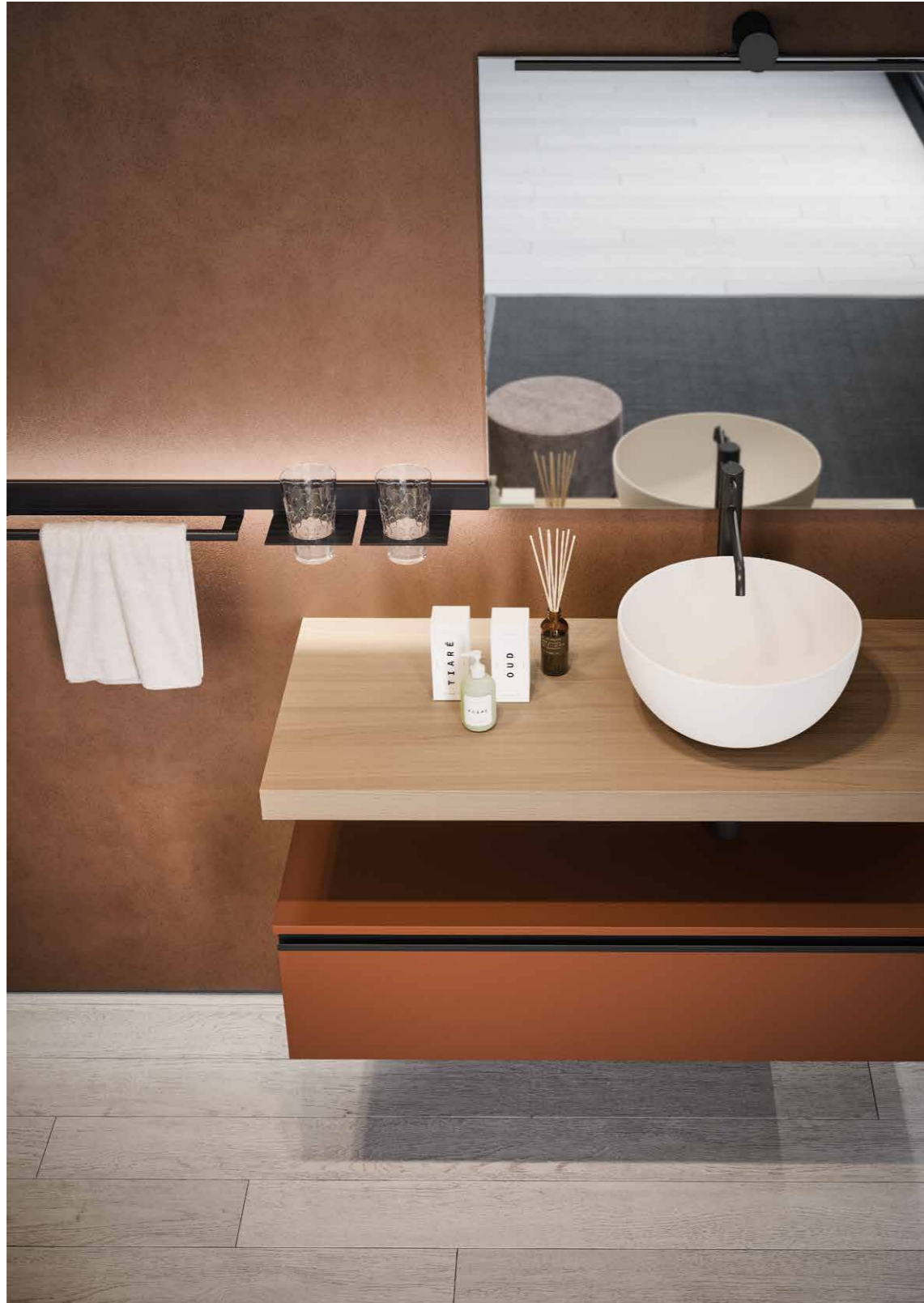

**Composition FO_004**

Top with countertop washbasin:
 White Chestnut wood veneer finish
 W 120 cm H 6 cm
Aurora countertop washbasin in
 matt white ceramic H 20 cm

Additional wall-hung base unit:
 W 120 cm
 D 51 cm
 H 30 + 1,2 cm
 Matt Ruggine lacquered

Handles:
 Matt black

Stilo basin mixer:
 Brushed black

Easy mirror:
 W 80 cm - H 80 cm

Tetris lamp:
 Matt black

Line bar, accessories and modules:
 Brushed black with Stop Sol glass door
 W 90 + 30 + 45 cm - H 130 cm

_Complements
 Kim Pouf

Composizione FO_004

Top con lavabo in appoggio:
 Finitura impiallacciato White Chestnut
 W 120 cm H 6 cm
Lavabo in appoggio Aurora in
 ceramica bianco opaco H 20 cm

Base complementare:
 W 120 cm
 D 51 cm
 H 30 + 1,2 cm
 Laccato Ruggine opaco

Maniglia:
 Nero opaco

Miscelatore lavabo Stilo:
 Nero spazzolato

Specchio Easy:
 W 80 cm - H 80 cm

Lampada Tetris:
 Nero opaco

Barra Line, accessori e moduli:
 Nero spazzolato con ante vetro Stop Sol
 W 90 + 30 + 45 cm - H 130 cm

_Complementi
 Pouf Kim

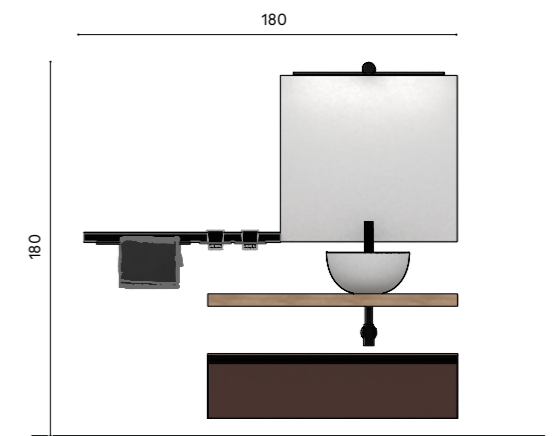

FOREVER_005

BIANCO GHIACCIO - LAVA OAK

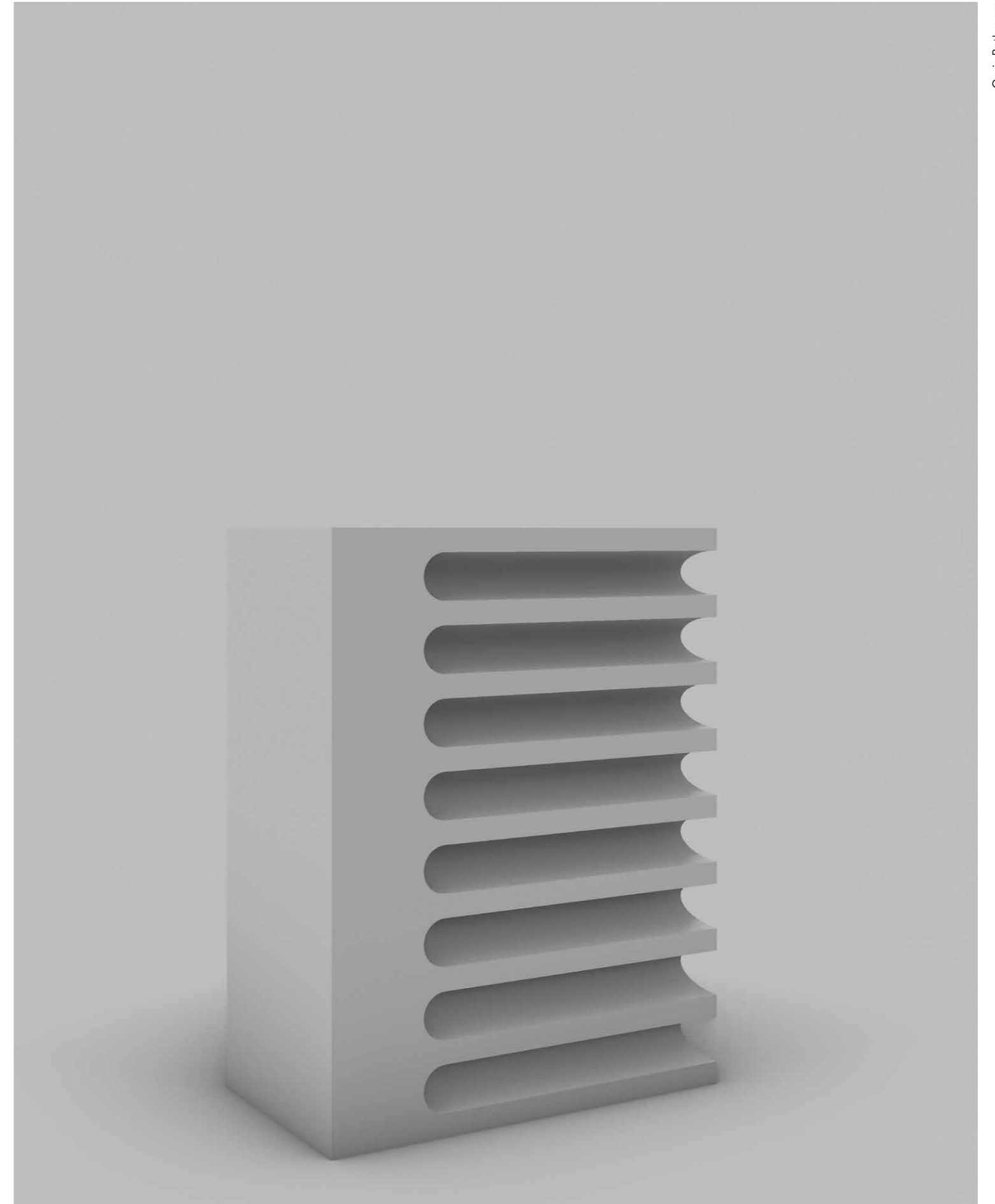





In the variation, the ROMA backlit mirror is composed of an external panel and perimeter in smoked mirror. Pictured is the largest model measuring 105 x 105 cm.

Nella variante lo specchio retroilluminato ROMA è composto da un pannello esterno e dal perimetro in specchio fumé ed è qui rappresentato nella sua versione più grande 105 x 105 cm.



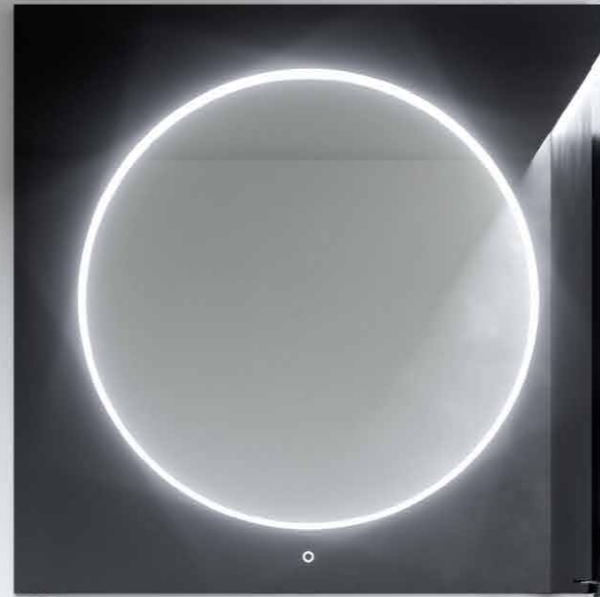







Composition FO_005

Structure:
W 120 cm
D 51 cm
H 56 + 1,2 cm
Matt Bianco Ghiaccio lacquered finish

Handles:
Matt black

Top:
"Frank" integrated
top in matt white ceramic

Stilo basin mixer:
Brushed black

Dali full mirror:
W 120 cm – H 105 cm

Line bar and modules:
Brushed black with Stop Sol glass doors
W 45 + 30 cm – H 76 cm

Riga Boiserie:
Panels in N0004 Lava Oak Melamine
wood, shelves in brushed black
aluminium

Volcano bathtub:
Matt black Lightfeel

Stilo freestanding bath mixer:
Brushed black

_Complements
Kim Pouf

_Variante shown Structure:
Matt Grigio Elegance lacquered finish

Top:
Matt white resin with
Karl integrated washbasin

Roma mirror:
W 105 cm – H 105 cm

Composizione FO_005

Struttura:
W 120 cm
D 51 cm
H 56 + 1,2 cm
Laccato bianco ghiaccio opaco

Maniglie:
Nero opaco

Top:
Top integrato "Frank" in
ceramica bianca opaca

Miscelatore lavabo Stilo:
Nero spazzolato

Specchio Dali full:
W 120 cm – H 105 cm

Barra Line e moduli:
Nero spazzolato con ante vetro Stop Sol
W 45 + 30 cm – H 76 cm

Boiserie Riga:
Pannello in Nobilitato N0004 Lava Oak,
mensole in alluminio nero spazzolato

Vasca Volcano:
Lightfeel nero lavagna opaco

Colonna miscelatore vasca da terra Stilo:
Nero spazzolato

_Complementi
Pouf Kim

_Variante
Struttura:
Laccato Grigio elegance opaco

Top:
Resina bianco opaco con
vasca integrata Karl

Specchio Roma:
W 105 cm – H 105 cm

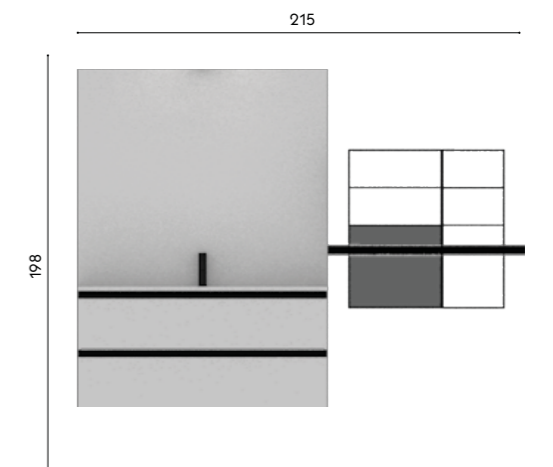

FOREVER_006

ROSSO JAIPUR

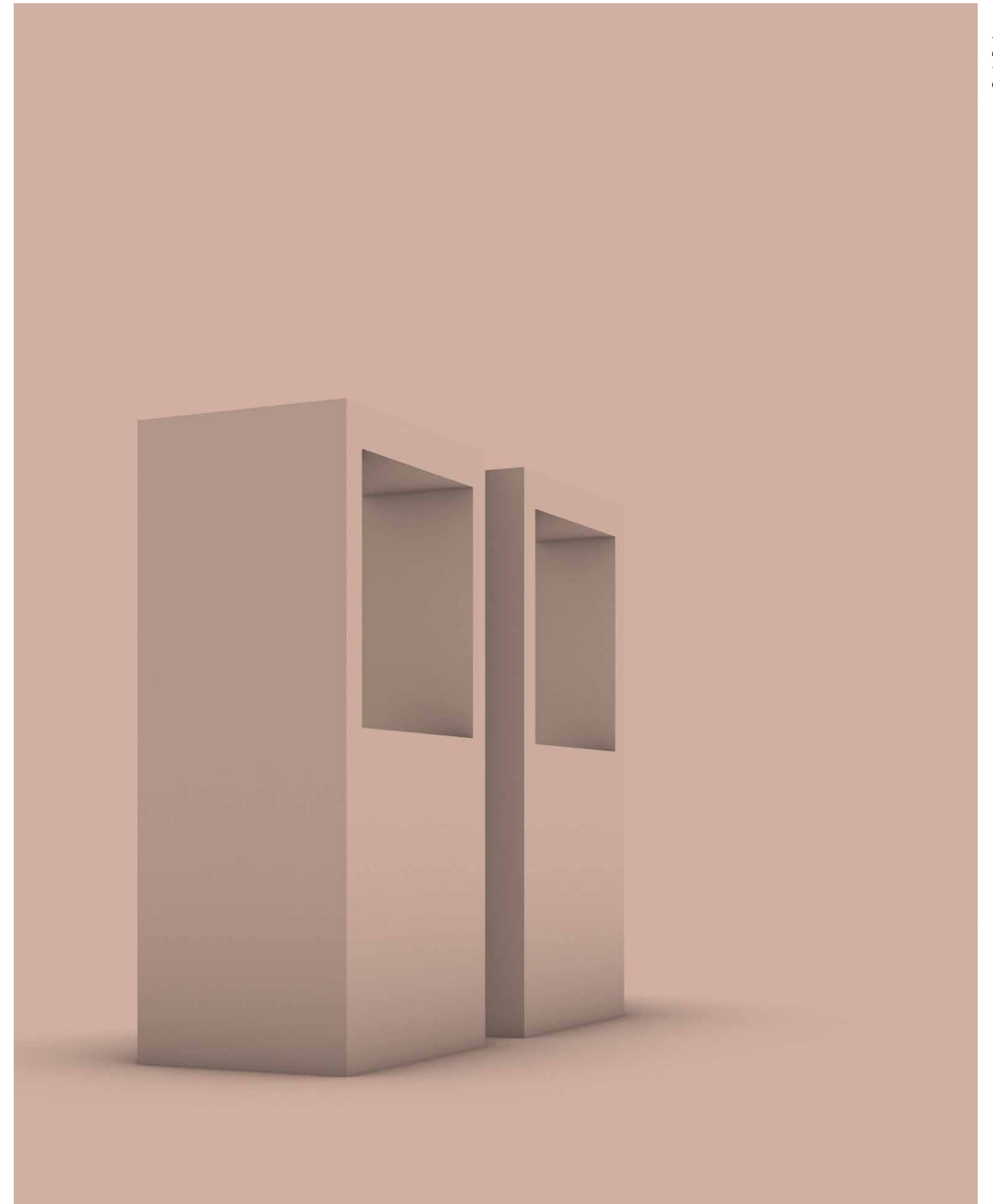



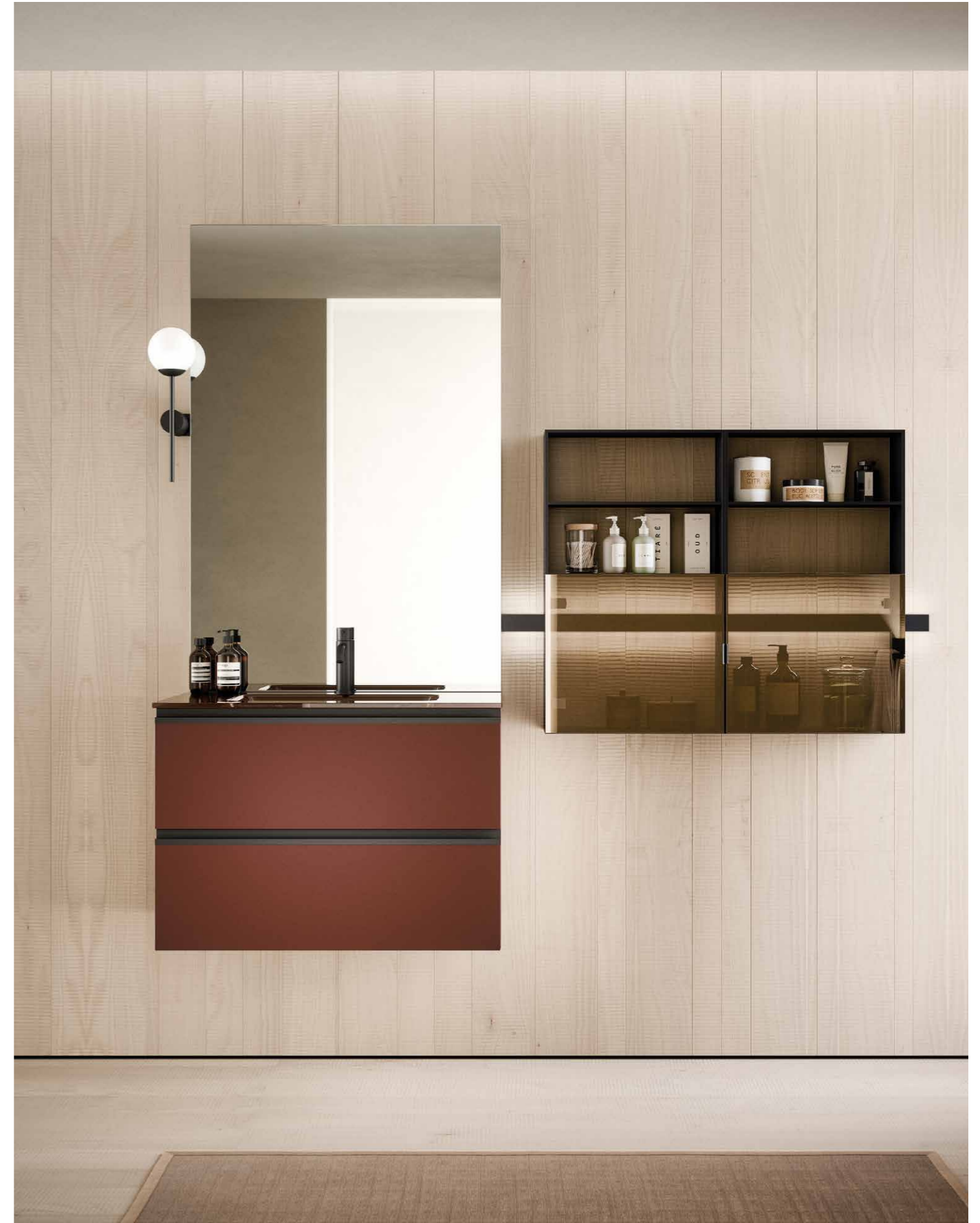



In this composition, the LINE bar is shown with 2 modules each 45 cm wide and featuring Stop Sol glass doors. The bar together with the LUME lamp, which is fixed above the EASY mirror, act as a light source for the entire setting.

The variation shows how the handles may match with the composition's finish.

In questa composizione la barra luminosa LINE è composta da due moduli da 45 cm con ante in vetro Stop Sol. Quest'ultima, insieme alla lampada LUME fissata allo specchio EASY, dona luce all'ambiente. La variante dimostra come le maniglie possono essere abbinata alla finitura del mobile.

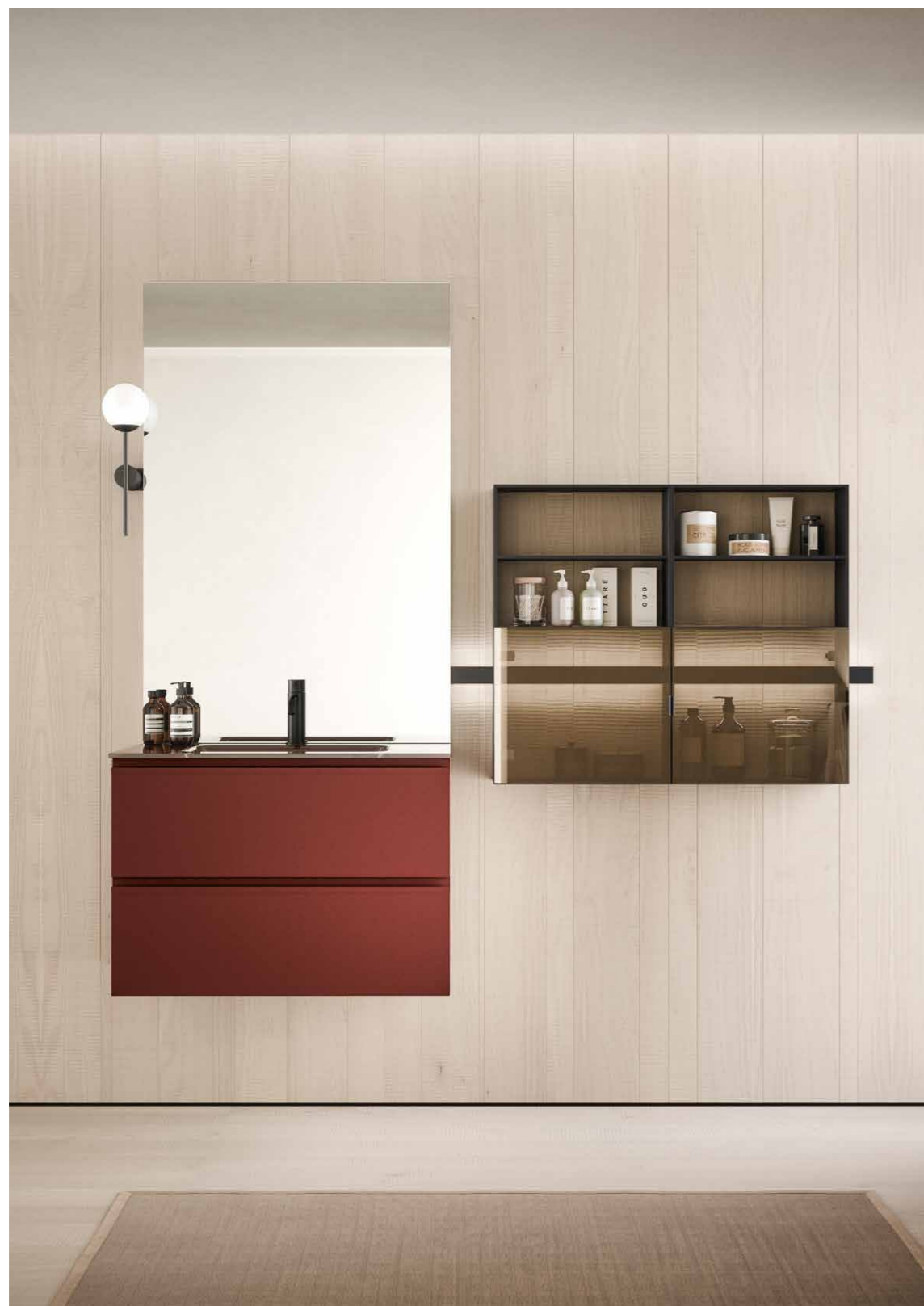

**Composition FO_006**

Structure:
 W 80 cm
 D 51 cm
 H 56 + 1,2 cm
 Matt Rosso Jaipur lacquered finish

Handles:
 Matt black

Top:
 Rosso Jaipur coloured glass with Rose integrated washbasin

Stilo basin mixer:
 Brushed black

Easy mirror:
 W 80 cm – H 120 cm

Lume lamp:
 Matt black

Line bar, accessories and modules:
 Brushed black with Stop Sol glass doors
 W 45 + 45 cm – H 76 cm

Wall-hung Sidney sanitary ware:
 White matt ceramic

Stilo bidet mixer:
 Brushed black

_Variation shown:
Handles:
 Rosso Jaipur

Composizione FO_006

Struttura:
 W 80 cm
 D 51 cm
 H 56 + 1,2 cm
 Laccato opaco rosso Jaipur

Maniglie:
 Nero opaco

Top:
 Vetro verniciato rosso Jaipur con vasca integrata Rose

Miscelatore lavabo Stilo:
 Nero spazzolato

Specchio Easy:
 W 80 cm – H 120 cm

Lampada Lume:
 Nero opaco

Barra Line, accessori e moduli:
 Nero spazzolato con ante vetro Stop Sol
 W 45 + 45 cm – H 76 cm

Sanitari Sidney sospesi:
 Ceramica bianca opaca

Miscelatore per bidet Stilo:
 Nero spazzolato

_Variante:
Maniglie:
 Rosso Jaipur

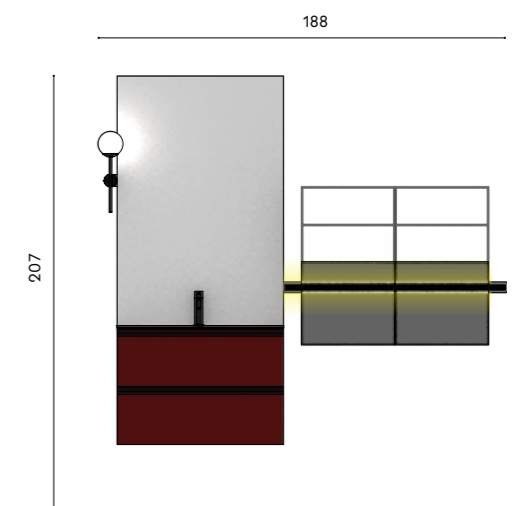

FOREVER_007

GREEN - GRIGIO PIETRA

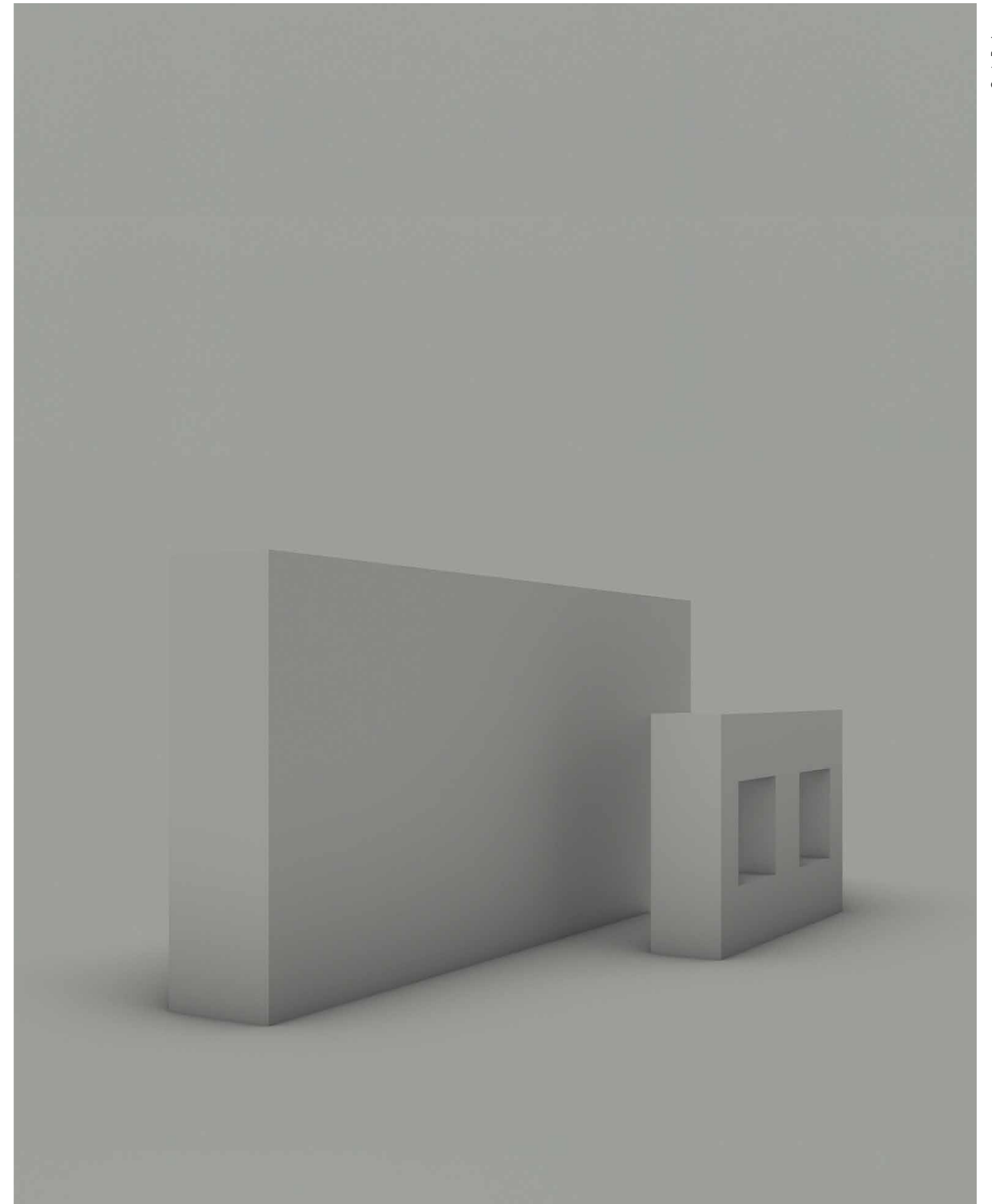





The handles and fronts are in a Green lacquer finish and the vanity is composed of two drawers, 120 cm wide.

Le maniglie e i frontali sono in finitura laccato Green e l'intera composizione è composta da due cassetti larghi 120 cm.



**Composition FO_007**

Structure:
W 120 cm
D 51 cm
H 56 + 1,2 cm
Matt Green lacquered finish

Handles:
Green lacquered finish

Top:
"Frank" integrated
top in white ceramic

Stilo basin mixer:
Brushed steel

Easy mirror:
W 120 cm – H 80 cm

Cube wall-hung tall unit:
Grigio pietra lacquered finish Holy black
handle H 196 cm

Open wall-hung tall unit:
N0003 Ash oak Melamine wood finish
H 196 cm

Defilè accessories:
Chrome

Rigel bathtub:
Matt white Purefeel

Freestanding bathtub mixer Stilo:
Brushed steel

_Complements
Marlene side table

Composizione FO_007

Struttura:
W 120 cm
D 51 cm
H 56 + 1,2 cm
Laccato opaco Green

Maniglie:
Laccato Green

Top:
Top integrato "Frank" in
ceramica bianca lucida

Miscelatore lavabo Stilo:
Acciaio spazzolato

Specchio Easy:
W 120 cm – H 80 cm

Colonne Cube:
Laccate Grigio pietra
maniglia nera Holy
H 196 cm

Colonna con vano a giorno Open:
Nobilitato N0003 Ash oak H 196 cm

Accessori Defilè:
Cromo

Vasca Rigel:
Purefeel bianco opaco

Colonne miscelatore vasca da terra
Stilo:
Acciaio spazzolato

_Complementi
Tavolini Marlene

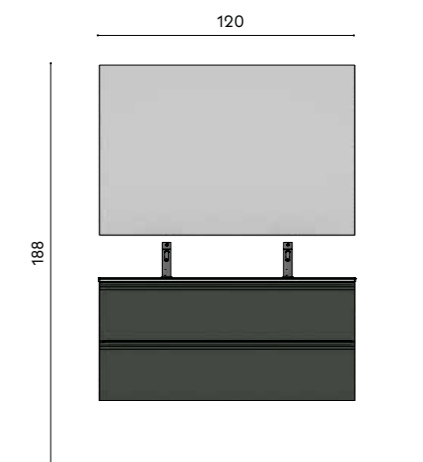

FOREVER_008

ACORN

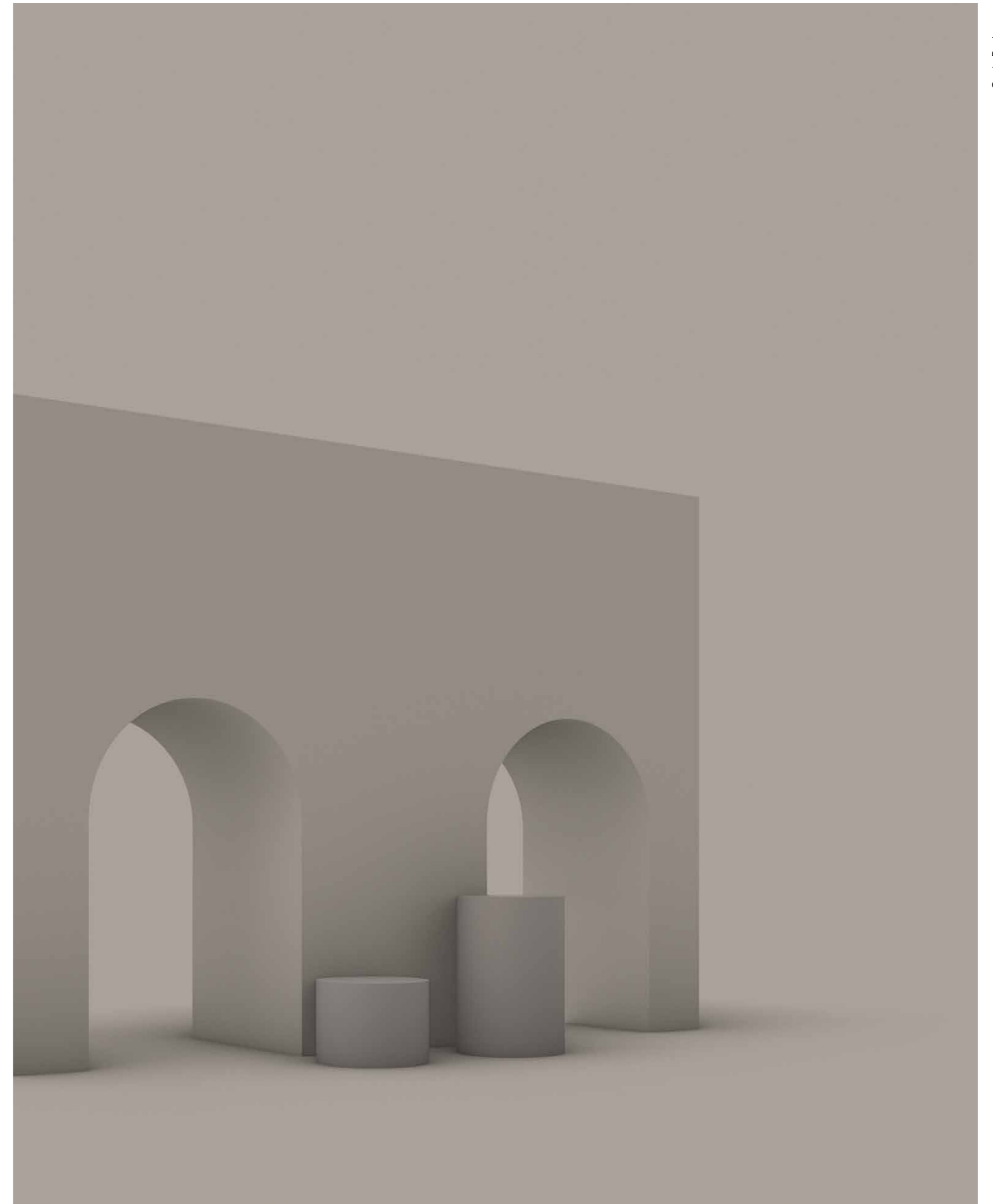





The composition features four drawers in Acorn melamine finish and has an overall length of 160 cm, the same dimension as for the backlit DALÍ FULL mirror.

La composizione prevede quattro cassetti in finitura nobilitato Acorn ed è larga complessivamente 160 cm, medesima dimensione dello specchio retroilluminato DALÍ FULL.

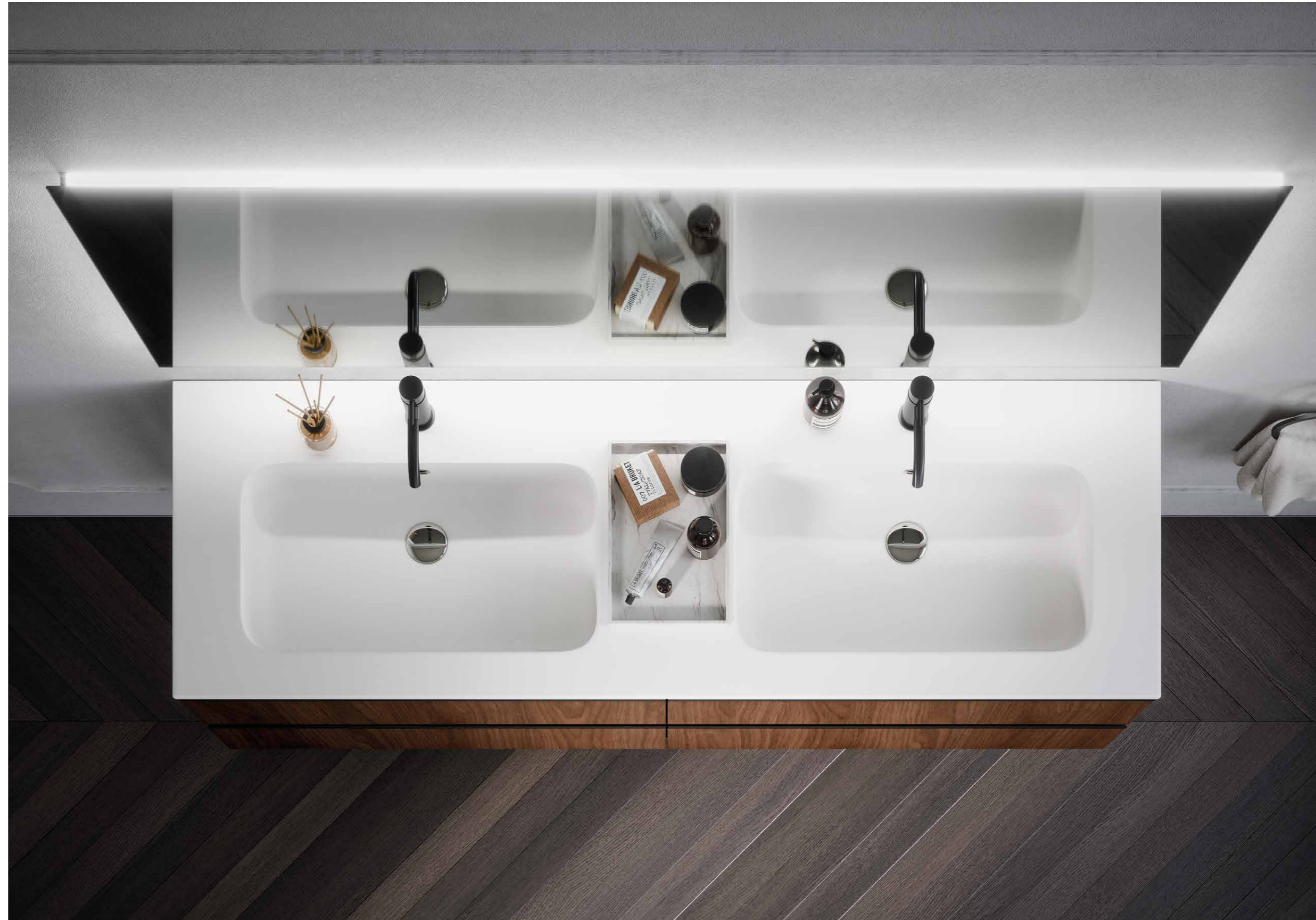

**Composition FO_008**

Structure:
 W 80 + 80 cm
 D 51 cm
 H 56 + 1,2 cm
 N0002 Acorn Melamine wood

Handles:
 Matt black

Top:
 "Karl" integrated top
 in matt white resin

Stilo basin mixer:
 Brushed black

Dalí Full mirror:
 W 160 cm – H 80 cm

Defilé accessories:
 Black matt

Hamal bathtub:
 Matt White Purefeel

**Stilo rim-mounted mixer with spout and
 hand shower:**
 Brushed black

_Complements
 Medea Side table

Composizione FO_008

Struttura:
 W 80 + 80 cm
 D 51 cm
 H 56 + 1,2 cm
 Nobilitato N0002 Acorn

Maniglie:
 Nero opaco

Top:
 Top integrato "Karl"
 in resina bianca opaca

Miscelatore lavabo Stilo:
 Nero spazzolato

Specchio Dalí Full:
 W 160 cm – H 80 cm

Accessori Defilé:
 Nero opaco

Vasca Hamal:
 Purefeel bianco opaco

**Miscelatori bordo vasca con bocca
 di erogazione e doccia Stilo:**
 Nero spazzolato

_Complementi
 Tavolini Medea

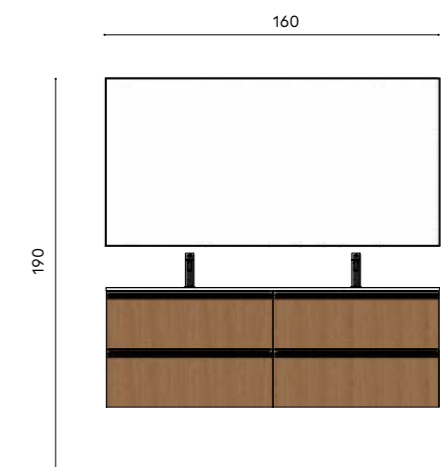

FOREVER_009

LAVA OAK - CAFFÈ

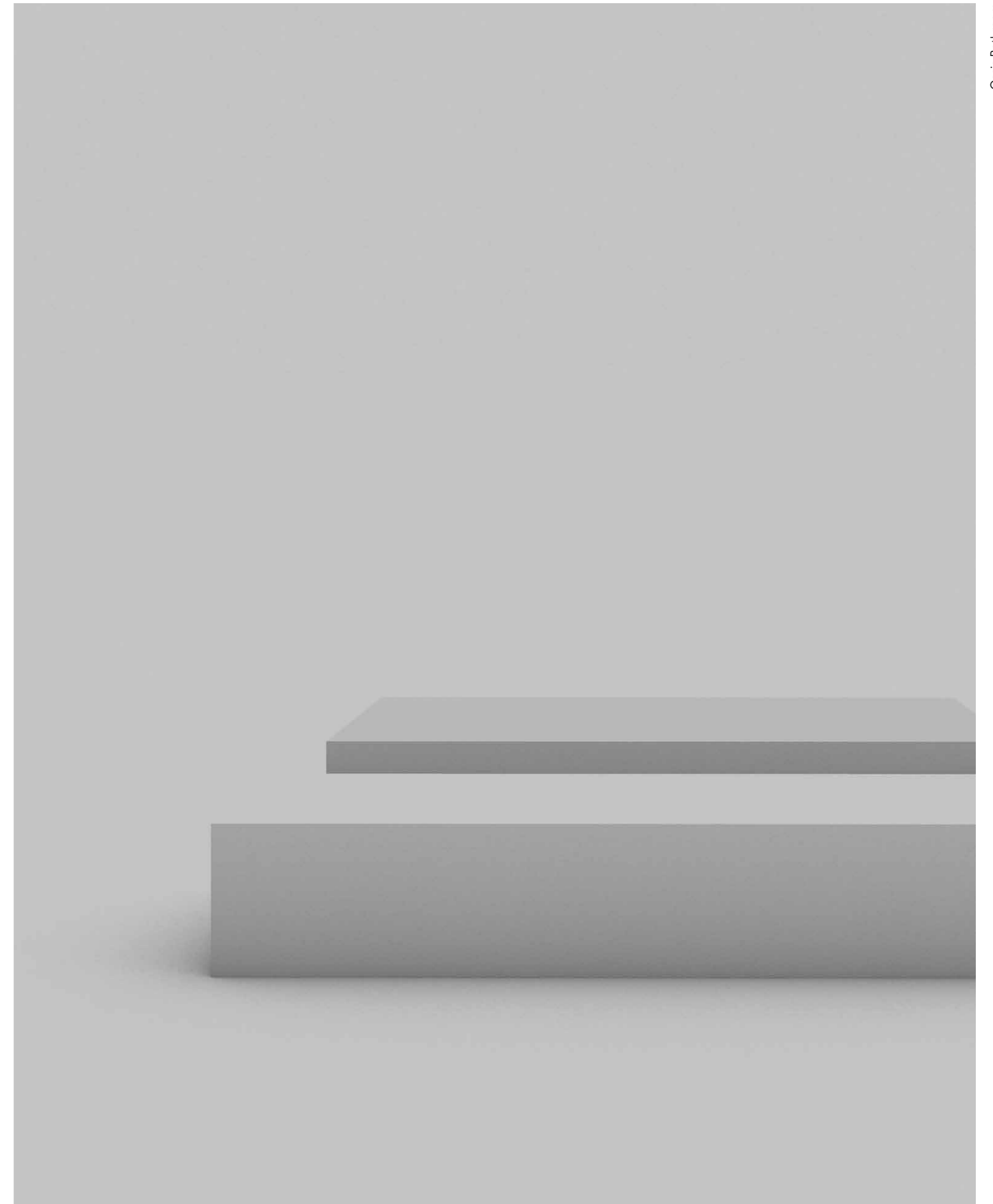







The composition is characterised by a 210 cm shelf in Caffè Elegance lacquered fitted below the basin and acting as both decoration and a support structure. Also shown is N0007 Caffè finish RIGA boiserie together with N0004 Lava Oak CUBE tall units.

La composizione è caratterizzata da una mensola sottolavabo lunga 210 cm in finitura laccato Caffè Elegance che funge da elemento decorativo e d'appoggio insieme alla boiserie RIGA in finitura nobilitata N0007 Caffè e alle colonne CUBE in Nobilitato N0004 Lava Oak.



**Composition FO_009**

Structure:
 W 105 + 105 cm
 D 51 cm
 H 30 + 1,2 cm
 N0004 Lava Oak Melamine wood

Handles:
 Matt black

Shelf fitted below the basin:
 Matt Nero Lavagna lacquered H 6 cm

Top:
 Matt White Purefeel with Edy integrated washbasin

Stilo basin mixer:
 Brushed black

Dali full mirror:
 W 210 cm – H 80 cm

Defilè accessories:
 Matt black

Cube tall units:
 N0004 Lava Oak Melamine wood
 H 196 cm
 Matt black Mauri handles

Riga Boiserie:
 Pannelli in N0007 Caffè Melamine wood
 Shelf in brushed black aluminium

Volcano bathtub:
 Matt white Lightfeel

Stilo freestanding bath mixer:
 Brushed black

Composizione FO_009

Struttura:
 W 105 + 105 cm
 D 51 cm
 H 30 + 1,2 cm
 Nobilitato N0004 Lava Oak

Maniglie:
 Nero opaco

Mensola sottolavabo:
 Laccato Nero Lavagna opaco H 6 cm

Top:
 Purefeel bianco opaco con vasca integrata Edy

Miscelatore lavabo Stilo:
 Nero spazzolato

Specchio Dali full:
 W 210 cm – H 80 cm

Accessori Defilè:
 Nero opaco

Colonne Cube:
 Nobilitato N0004 Lava Oak
 H 196 cm
 Maniglie Mauri nero opaco

Boiserie Riga:
 Pannelli in Nobilitato N0007 Caffè,
 mensole in alluminio nero spazzolato

Vasca Volcano:
 Lightfeel bianco opaco

Colonne miscelatore vasca da terra
 Stilo:
 Nero spazzolato

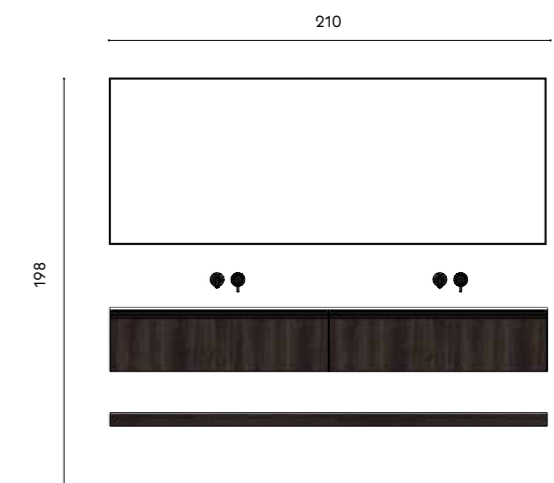

FOREVER_010

DARK GREY METAL - WHITE PUREFEEL

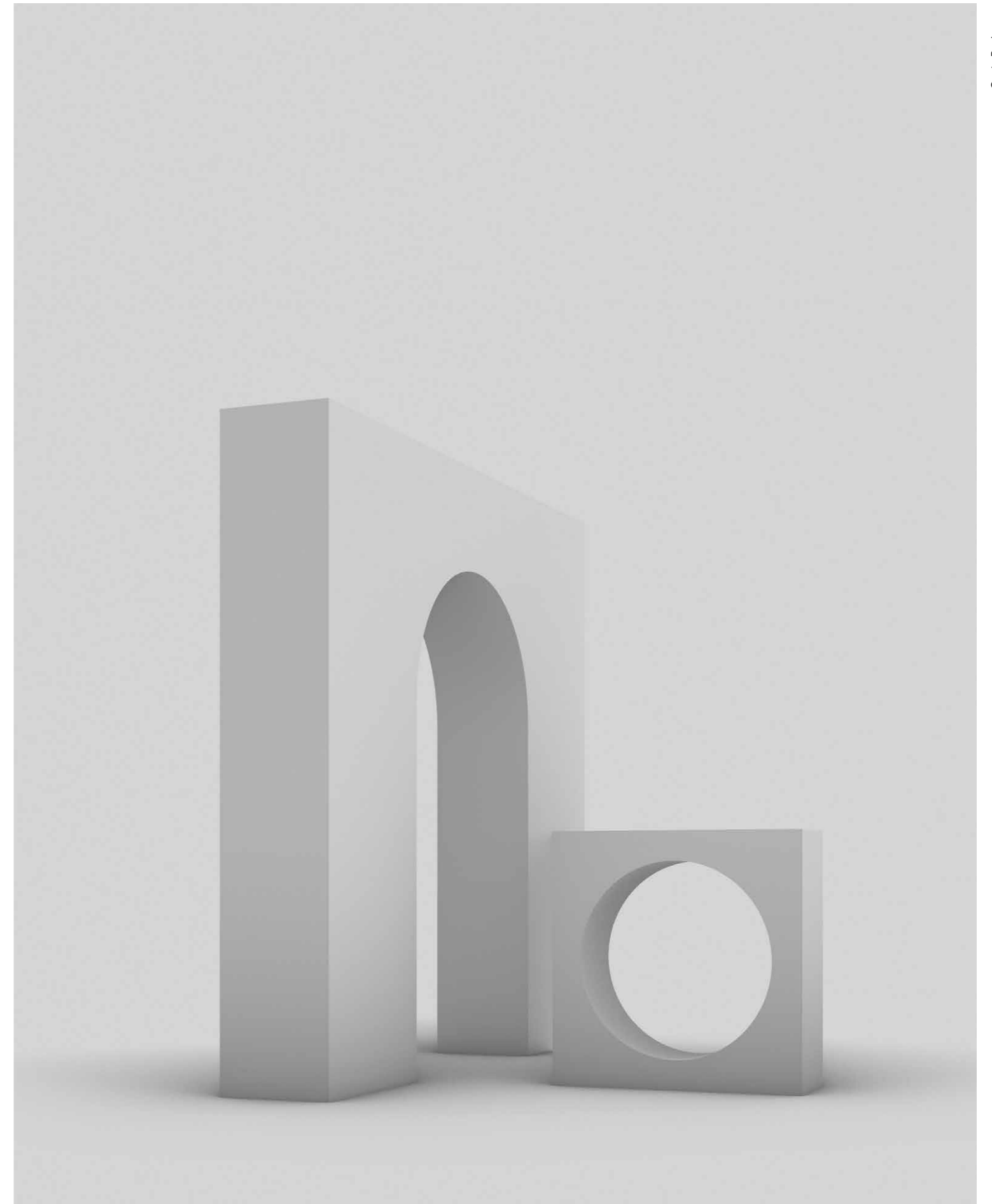





The rectangular MARY Countertop washbasin in matt white Purefeel is also available in all the matt colours of the Oasis lacquer chart. Of contrasting shape is the round Ø 80 cm backlit JOYCE mirror.

Il lavabo in appoggio MARY dalla forma squadrata in finitura purefeel bianco opaco è disponibile in tutte le finiture opache della mazzetta colori Oasis e le sue forme sono accostate a quella circolare dello specchio retroilluminato JOYCE con diametro 80 cm.



**Composition FO_010**

Structure:
 W 105 + 105 cm
 D 51 cm
 H 30 + 1,2 cm
 Dark grey metallic lacquer

Handles:
 Matt Black

Top with countertop washbasin:
 Matt White Purefeel Mary

Countertop washbasin:
 Matt White Purefeel

Stilo basin mixer:
 Brushed Black

Joyce Mirror:
 Ø 80 cm

Defilè accessories:
 Matt black

Volcano Bathtub:
 Matt White Lightfeel

Stilo freestanding bathtub mixer:
 Brushed Black

_Complements
 Marlene Coffee table

Composizione FO_010

Struttura:
 W 105 + 105 cm
 D 51 cm
 H 30 + 1,2 cm
 Laccato Dark grey metal

Maniglie:
 Nero opaco

Top con lavabo in appoggio:
 Purefeel bianco opaco
 Lavabo in appoggio Mary in
 Purefeel bianco opaco

Miscelatore lavabo Stilo:
 Nero spazzolato

Specchio Joyce:
 Ø 80 cm

Accessori Defilè:
 Nero opaco

Vasca Volcano:
 Lightfeel bianco opaco

Colonne miscelatore vasca da terra
 Stilo:
 Nero spazzolato

_Complementi
 Tavolini Marlene

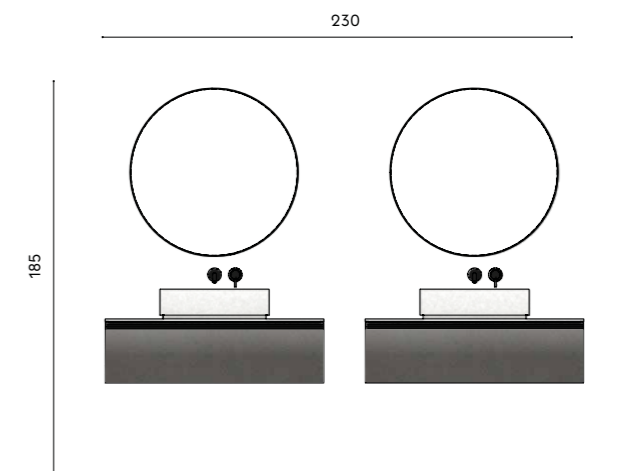

FOREVER_011
ASH OAK - PURE WHITE

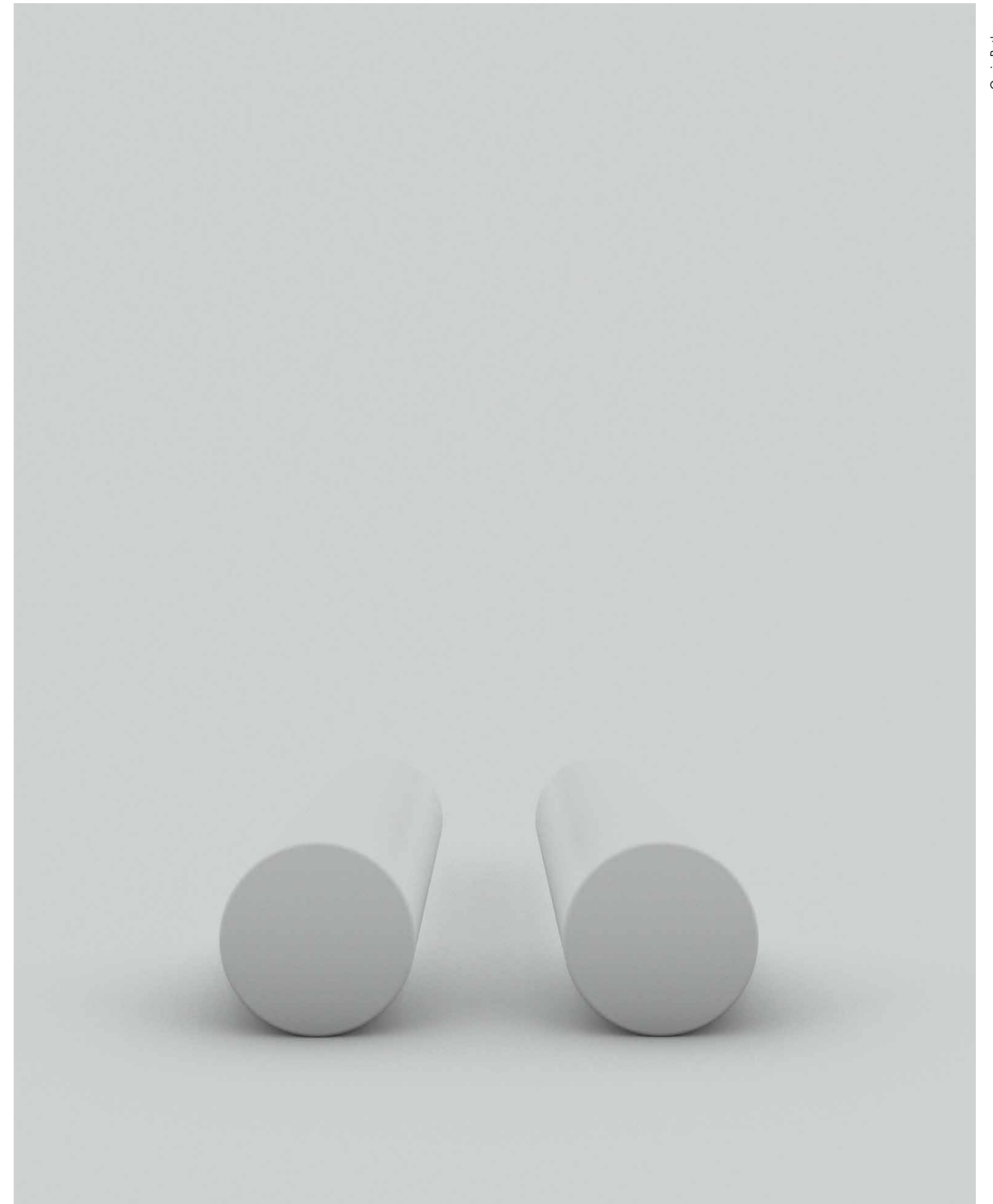





The PARIS SQUARE mirror without switch comes complete with four LED lamps in black finish. These are direction-adjustable. Also shown are three ALU tall units of width 70 cm and height 196 cm.

Lo specchio PARIS SQUARE è completo di quattro lampade Led in finitura nera senza interruttore e ruotabili, consentendo così di poter direzionare la luce. La composizione è abbinata alle tre colonne ALU larghe 70 cm e alte 96 cm.





**Composition FO_011**

Structure:
W 70 + 70 cm
D 51 cm
H 56 + 1,2 cm
Pure white N0005 Melamine finish

Handles:
Matt black

Top:
"Karl" integrated top in
matt white resin

Stilo basin mixer:
Brushed black

Paris Square Mirror:
W 140 cm – H 80 cm

**Alu wall-hung tall units with integrated
LED lighting behind the shelves:**
Brushed black aluminum frame
with smoked glass H 196 cm and inner
side in N0003 Ash Oak Melamine

Defilè accessories:
Matt black

Rigel bathtub:
Matt White Purefeel

Stilo freestanding bathtub mixer:
Brushed black

_Complements
Marlene side tables

_Variation shown
Top:
Matt white resin with Karl integrated
washbasin positioned to the left

Paris Square mirror:
W 140 cm – H 80 cm with lamps
positioned to the left

Composizione FO_011

Struttura:
W 70 + 70 cm
D 51 cm
H 56 + 1,2 cm
Nobilitato Pure white N0005

Maniglie:
Nero opaco

Top:
Top integrato "Karl" in
resina bianca opaca

Miscelatore lavabo Stilo:
Nero spazzolato

Specchio Paris Square:
W 140 cm – H 80 cm

**Colonne Alu con luce led integrata
dietro i ripiani:**
Telaio in alluminio nero spazzolato
con vetro fumè H 196 cm e interno in
nobilitato N0003 Ash Oak

Accessori Defilè:
Nero opaco

Vasca Rigel:
Purefeel bianco opaco

Colonna miscelatore vasca da terra Stilo:
Nero spazzolato

_Complementi
Tavolini Marlene

_Variante
Top:
Resina bianco opaco con vasca
integrata Karl posizionata a sinistra

Specchio Paris Square:
W 140 cm – H 80 cm con lampade
posizionate a sinistra

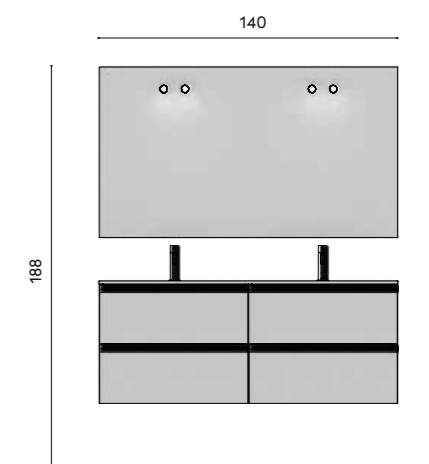

—
FOREVER_012
CAFFÈ
—

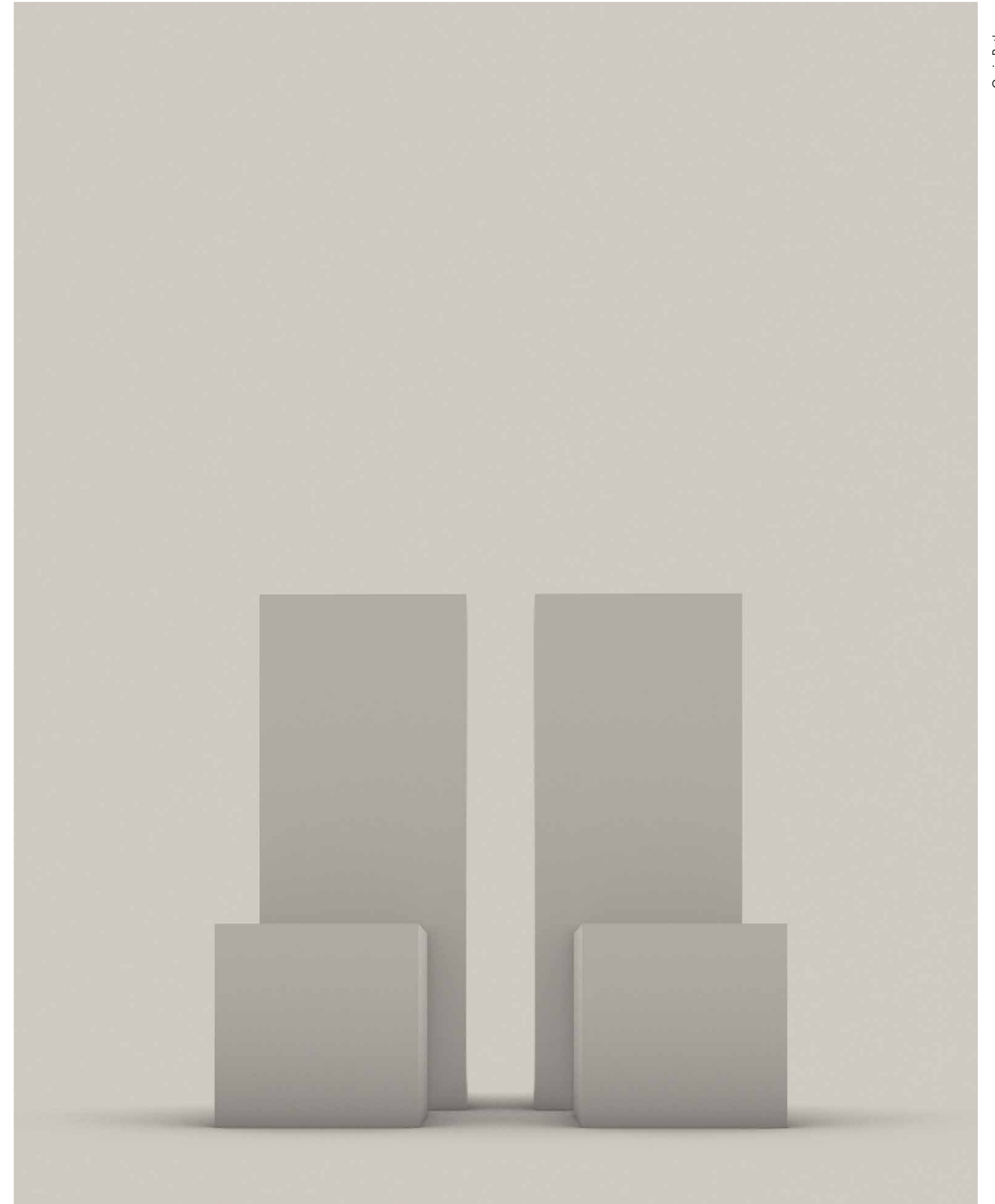



Oasis Bathroom



The black TOOBE lamps with a circumference of 3,8 cm are perfect complements for tall, narrow mirrors such as the DALÌ FULL model measuring 120 cm high and 60 cm wide.

Le lampade TOOBE nere con circonferenza 3,8 cm sono perfette per essere abbinare a specchi stretti e alti come questi DALÌ FULL alti 120 e larghi 60 cm.

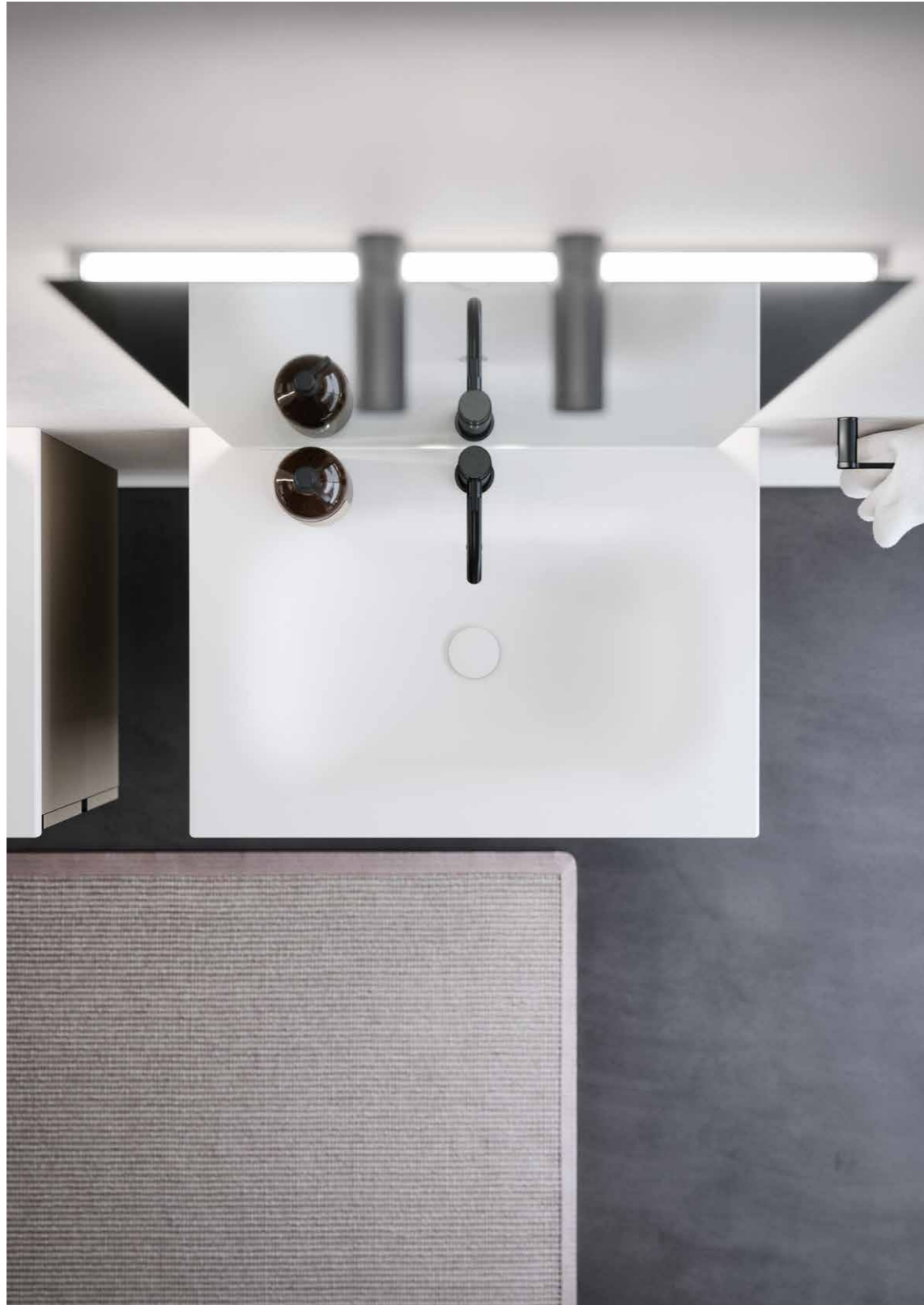

**Composition FO_012**

Structure:
 W 70 + 70 cm
 D 51 cm
 H 56 + 1,2 cm
 N0007 Caffè melamine wood finish

Handles:
 Matt black

Top:
 "Frank" integrated top
 in matt white ceramic

Stilo basin mixer:
 Brushed black

Dali Full mirror:
 W 60 cm - H 120 cm

Toobe lamps:
 Matt Black

Defilé accessories:
 Matt black

_Complements
 Kim pouf

Composizione FO_012

Struttura:
 W 70 + 70 cm
 D 51 cm
 H 56 + 1,2 cm
 Nobilitato N0007 Caffè

Maniglie:
 Nero opaco

Top:
 Top integrato "Frank" in
 ceramica bianca opaca

Miscelatore lavabo Stilo:
 Nero spazzolato

Specchio Dali Full:
 W 60 cm - H 120 cm

Lampade Toobe:
 Nero opaco

Accessori Defilé:
 Nero opaco

_Complementi
 Pouf Kim

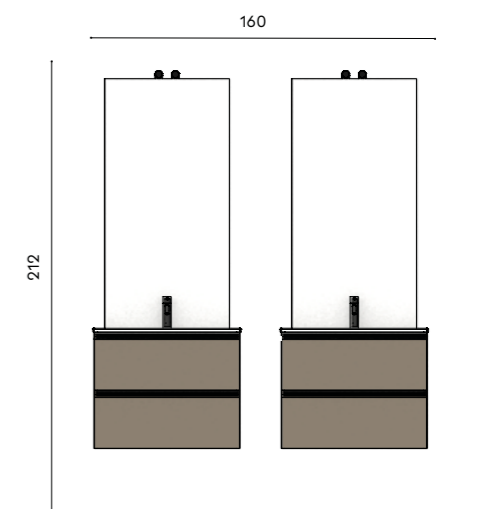

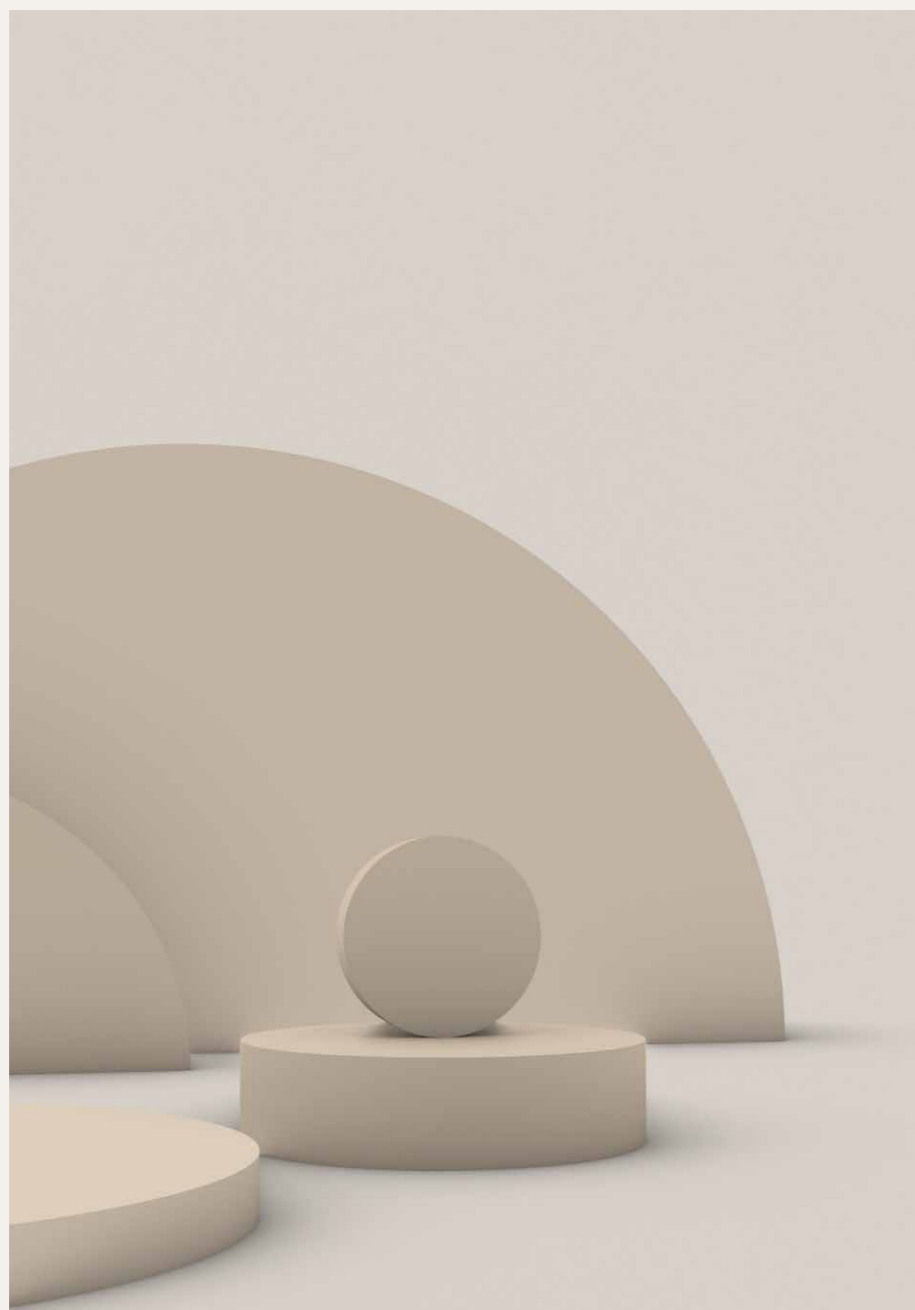

Technical Data and Finishes

Each collection is unique, with its own technical characteristics and modularity. Each collection comes with a wide range of products, sizes and materials. All products are completely Made in Italy with high quality standards.

Ogni collezione è unica, con caratteristiche tecniche e modularità proprie. Ogni collezione viene fornita con una vasta gamma di prodotti, dimensioni e materiali. Tutti i prodotti sono completamente Made in Italy con elevati standard qualitativi.

FOREVER Technical Data

Forever Caratteristiche tecniche



Unit with integrated aluminium handle available in painted finish in all Oasis' colour chart
Mobile con maniglia integrata in alluminio disponibile in finitura verniciata in tutti i colori del campionario Oasis



New finishes in melamine wood and in coloured melamine
Nuove finiture in nobilitato legno e colorato

FOREVER Technical Data

Forever Caratteristiche tecniche



New integrated top in matt white resin with Karl washbasin
Nuovi top integrati in resina bianca opaca Karl

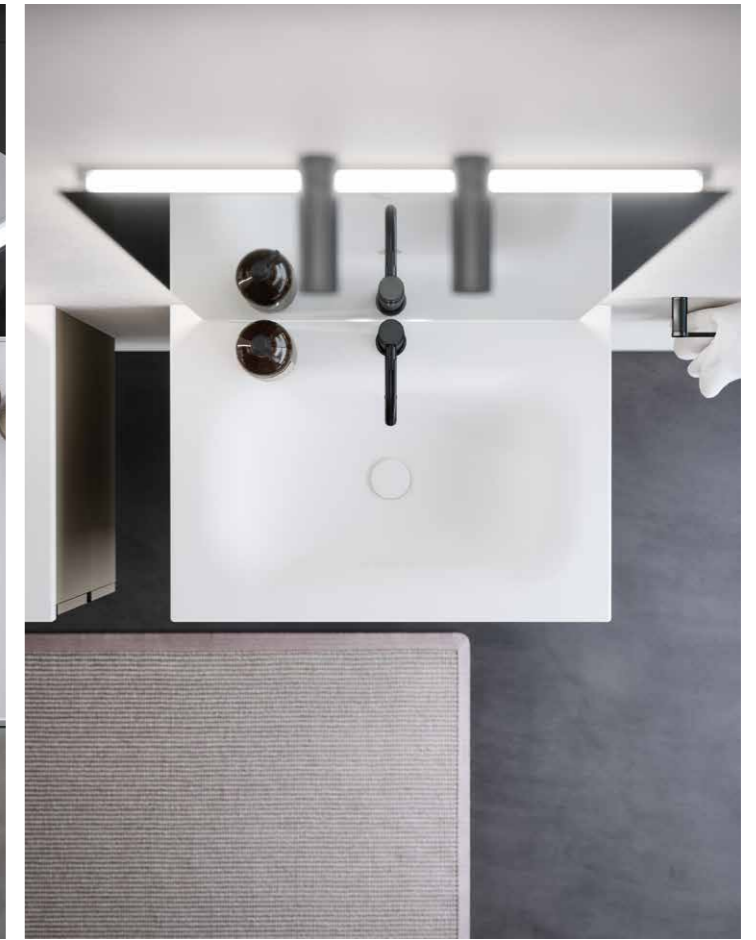

New integrated top in matt/glossy white ceramic with Frank washbasin
Nuovi top integrati in ceramica bianca opaca o lucida Frank

MODULARITY

Modularità



WALL MOUNTED ELEMENTS / MOBILI SOSPESI - H 30 CM

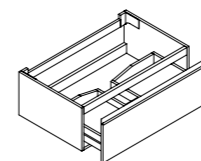

Wall mounted vanity with 1 drawer
Mobile portalavabo sospeso con 1 cassetto

W 60/70/80/90/105/120 cm
D 50,5 cm

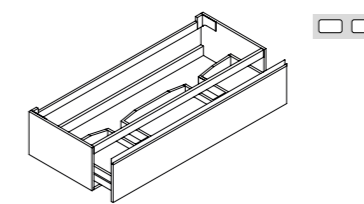

Wall mounted vanity with 1 drawer
Mobile portalavabo sospeso con 1 cassetto

W 120 cm
D 50,5 cm

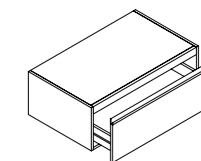

Additional wall-hung base unit with 1 drawer
Mobile complementare sospeso con 1 cassetto

W 25/35/45/60/70/80/90/105/120 cm
D 50,5 cm

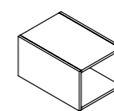

Suspended open cabinet
Base accostata sospesa a giorno

W 35/45 cm
D 49 cm

WALL MOUNTED ELEMENTS / MOBILI SOSPESI - H 56 CM

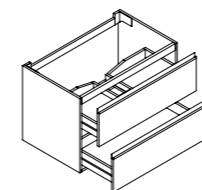

Wall mounted vanity with 2 drawers
Mobile portalavabo sospeso con 2 cassetti

W 60/70/80/90/105/120 cm
D 50,5 cm

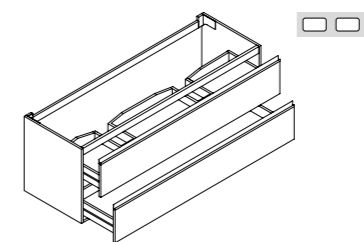

Wall mounted vanity with 2 drawers
Mobile portalavabo sospeso con 2 cassetti

W 120 cm
D 50,5 cm

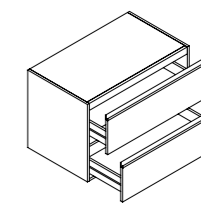

Additional wall-hung base unit with 2 drawers
Mobile complementare sospeso con 2 cassetti

W 25/35/45/60/70/80/90/105/120 cm
D 50,5 cm

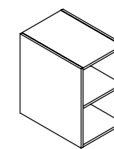

Additional wall-hung base unit with open shelf
Base complementare sospesa con vano a giorno

W 35/45 cm
D 49 cm

MODULARITY

Modularità

"CUBE" WALL-HUNG TALL UNITS WITH PUSH-PULL OPENING SYSTEM / COLONNE "CUBE" CON SISTEMA DI APERTURA PUSH-PULL - H 80/120/162 /196* CM

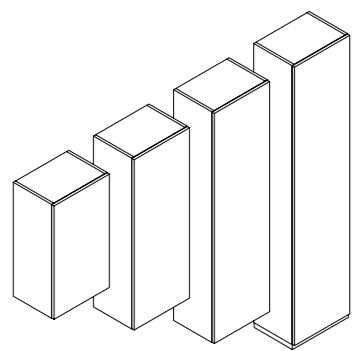

Wall-hung tall units
Colonne sospese

W 35/45/70/90 cm
D 25/35 cm

"CUBE" WALL- HUNG TALL UNITS WITH HANDLE / COLONNE "CUBE" CON MANIGLIA - H 80/120/162 /196* CM

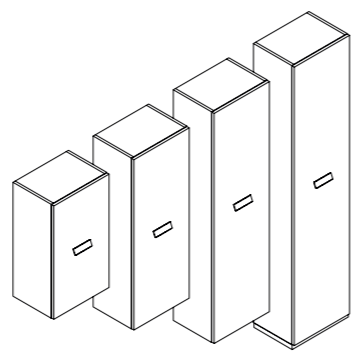

Wall-hung tall units
Colonne sospese

W 35/45/70/90 cm
D 25/35 cm



MAURI



HOLY

HANDLES / MANIGLIE

Available in 2 finishes: black or bronze / Disponibili in 2 finiture: nero e bronzo

"ALU" WALL-HUNG TALL UNITS WITH DOORS IN BLACK ALUMINIUM FRAME / COLONNE "ALU" CON ANTA TELAIO IN ALLUMINIO NERO - H 80/120/162 /196* CM

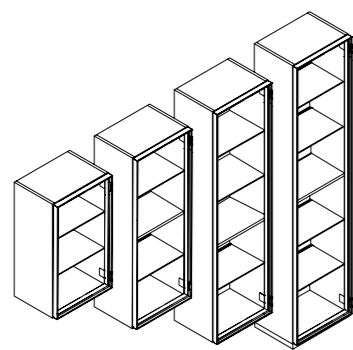

Wall-hung tall units
Colonne sospese

W 35/45/70/90 cm
D 25/35 cm

"MAX " WALL-HUNG TALL UNITS WITH CANTILEVER DOOR / COLONNE "MAX" CON ANTA A SBALZO - H 80/120/162 /196* CM

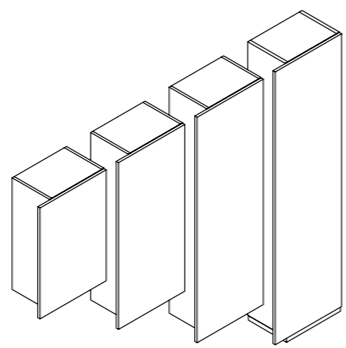

Wall-hung tall units
Colonne sospese

W 45 cm
D 25/35 cm

MODULARITY

Modularità

FOREVER WALL-HUNG TALL UNITS / COLONNE SOSPESSE FOREVER - H 164 CM



Suspended tall unit with 2
rh/lh doors
Colonna sospesa 2 ante dx-sx

W 35 cm
D 35 cm

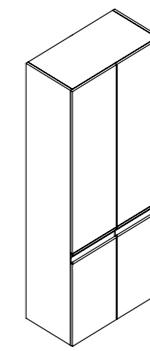

Suspended tall unit with 4
doors
Colonna sospesa 4 ante

W 70 cm
D 35 cm

"OPEN" WALL-HUNG TALL UNITS WITH OPEN SHELVES / COLONNE SOSPESSE CON VANO A GIORNO "OPEN" - H 80/120/162 /196* CM

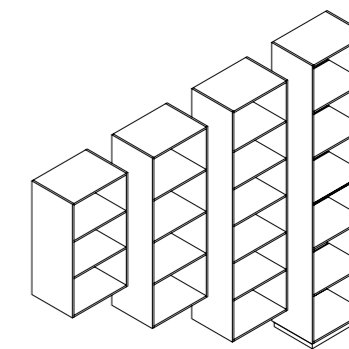

Wall-hung tall units
Colonne sospese con vano a
giorno

W 35/45 cm
D 25/35 cm

BOISERIE CUSTOM MADE "RIGA" / BOISERIE "RIGA" SU MISURA

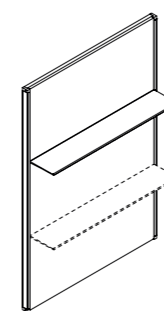

Boiserie custom made
Boiserie su misura

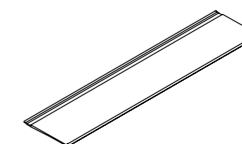

Shelf
Mensole
W 30/60/75/90/120

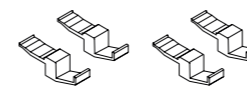

4 hooks set
Set 4 ganci

FOREVER WALL UNIT / PENSILI FOREVER - H 80 CM

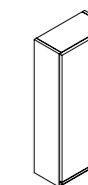

Wall cabinet with 1
Lh/rh door
Pensile 1 anta dx-sx

W 35 cm
D 19 cm

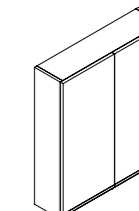

Wall cabinet with
2 Lh/rh doors
Pensile 2 ante

W 70 cm
D 19 cm



Open-shelving wall unit in
smoked glass
Pensile a giorno in vetro fumè

W 35 cm
D 15 cm

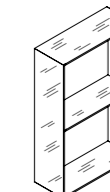

Open-shelving wall unit in
smoked glass
Pensile a giorno in vetro fumè

W 50 cm
D 15 cm

*FLOOR-STANDING TALL UNITS H 196 CM WITH PLINTH
*LE COLONNE A TERRA CON ALTEZZA 196 CM SONO COMPLETE DI ZOCCOLO
WITH LENGHT 70/90 CM, TALL UNITS ARE PROVIDED WITH 2 DOORS
NELLA LUNGHEZZA 70/90 CM COLONNA DOTATA DI DUE ANTE

*FLOOR-STANDING TALL UNITS H 196 CM WITH PLINTH
*LE COLONNE A TERRA CON ALTEZZA 196 CM SONO COMPLETE DI ZOCCOLO

LINE accessories collections

Accessori LINE

APPLICATION EXAMPLES / ESEMPI DI APPLICAZIONE

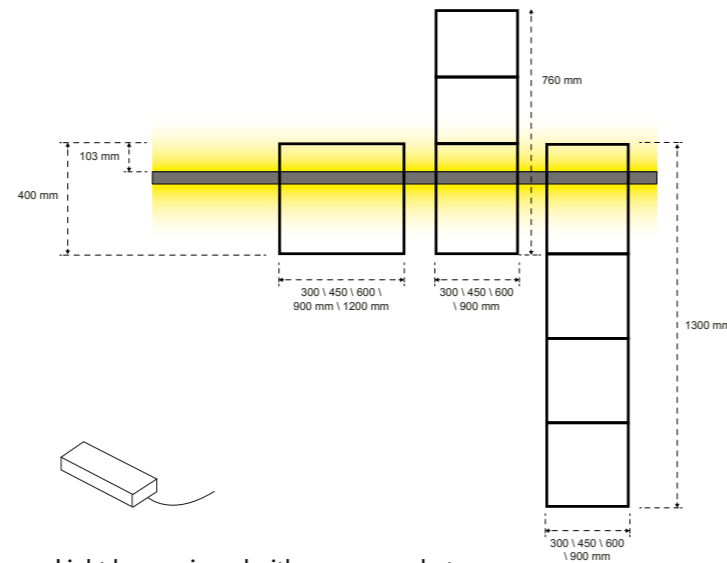

Light bar equipped with power supply to be positioned on the back of the mirrors or inside the element with plug and USB.

Barra luminosa fornita di alimentatore da posizionare sul retro delle specchiere o all'interno dell'elemento con presa elettrica e USB.

ACCESSORIES / ACCESSORI

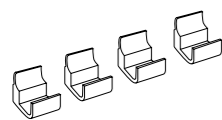

4 hooks set
Set 4 ganci
W 2 X H 2,5 X D 3,4 cm

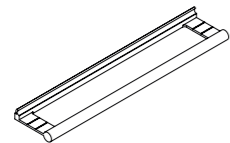

Towel rail
Portasalviette
W 45 X H 2,5 X D 9 cm

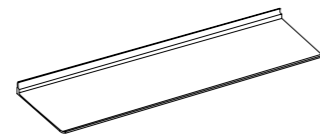

Shelf
Mensola
W 28,6/39/43,6/58,6/88,6 cm
H 2,4 X D 13 cm

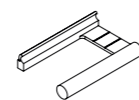

Paper roll holder
Porta rotolo
W 14 X H 2,5 X D 9 cm

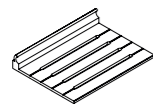

Soap holder
Porta sapone
W 15 X H 2,5 X D 11 cm

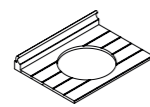

Tumbler holder
Porta bicchieri
W 15 X H 2,5 X D 11 cm

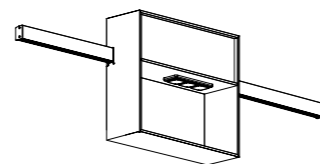

Box with electric socket and USB
Elemento con presa elettrica e USB
W 45 X H 40 X D 15 cm

2 SCHUKO
2 USB

LINE accessories collections

Accessori LINE

HORIZONTAL AND VERTICAL MODULES / MODULI ORIZZONTALI E VERTICALI

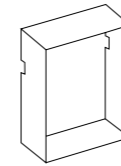

Wall unit with open
compartment
Pensile con vano a giorno

W 30/45/60 cm
H 40
D 15 cm

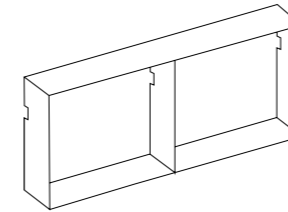

Wall unit with 2 open
compartments
Pensile con 2 vani a giorno

W 90
H 40 cm
D 15 cm

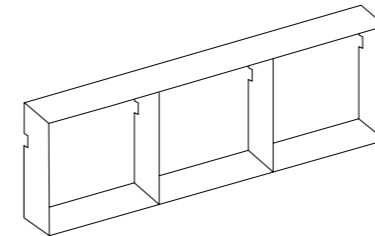

Wall unit with 3
open compartments
Pensile con 3 vani a
giorno

W 120
H 40 cm
D 15 cm

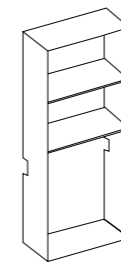

Vertical wall unit with 3 open
compartments
Pensile verticale con 3 vani a
giorno

W 30/45/60/90 cm
H 76 cm
D 15 cm

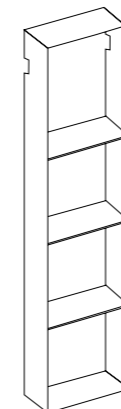

Vertical wall unit with 4 open
compartments
Pensile verticale con 4 vani
a giorno

W 30/45/60/90 cm
H 130
D 15 cm

MODULES WITH GLASS DOOR "STOP SOL" / MODULI CON ANTE IN VETRO "STOP SOL"

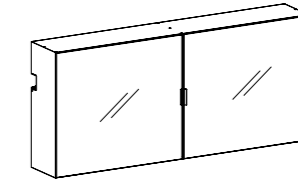

Wall unit with 2 glass doors
Pensile con 2 ante a vetro

W 90 cm
H 40
D 15 cm

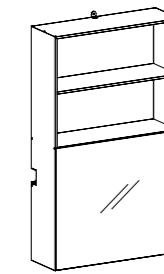

Wall unit with 1 glass door
and 2 open compartments
Pensile con 1 anta a vetro e
2 vani a giorno

W 45 cm
H 76
D 15 cm

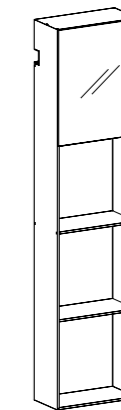

Vertical wall unit with 1
glass door and 3 open
compartments
Pensile verticale con 1 anta
a vetro e 3 vani a giorno

W 30 cm
H 130
D 15 cm

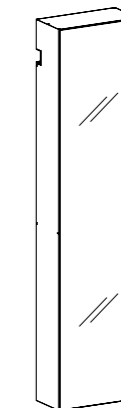

Vertical wall unit with 1
glass door
Pensile verticale con 1 anta
a vetro

W 30 cm
H 130
D 15 cm

BASIN TYPES FOR TOPS WITH INTEGRATED BASINS

Tipologie di lavabi per top con vasche integrate

MATT WHITE PUREFEEL - GLOSSY WHITE GEACRIL / PUREFEEL BIANCO OPACO - GEACRIL BIANCO LUCIDO - TOP H 1,2/ 12 CM



NICK
NICK 1 - W 50 X D 31 cm
NICK 2 - W 60 X D 31 cm



EDY
EDY 1 - W 50 X D 31,5 cm
EDY 2 - W 58,6 X D 31,5 cm



CUT
CUT 1 - W 48 X D 31 cm
CUT 2 - W 58 X D 31 cm



MATT WHITE RESIN / RESINA BIANCA OPACA



KARL
SINGLE BASIN - W 58 X D 31 cm
DOUBLE BASIN - W51 X D31 cm / W 58 X D 31 cm
Available only for vanit unit
Disponibile solo per base portavabo
W 70/80/90/105/120/140/160 cm

MATT WHITE LIGHTFEEL / LIGHTFEEL BIANCO OPACO - TOP H 1,2/ 12 CM



DROP
W 72 X D 31 cm



CIRCLE
Ø 42cm



HANNA
HANNA 1 - W 48 X D 30 cm
HANNA 2 - W 68 X D 30 cm
Available with upper removable panel / Disponibile con elemento superiore amovibile



FRANK
Available only for vanit unit
Disponibile solo per base portavabo
W 60/70/80/90/105/120 cm

FENIX NTM® TOP H 1,2/ 12 CM

GLOSSY - MATT WHITE CERAMIC / CERAMICA BIANCA LUCIDA - OPACA

MATT CORIAN® / CORIAN® OPACO - TOP H 1,2/ 12 CM



PAUL
PAUL 1 - W 50 X D 31,5 cm
PAUL 2 - W 60 X D 31,5 cm



HARRY
HARRY 1 - W 59 X D 34 cm
HARRY 2 - W 68 X D 38 cm



ROCK
ROCK 1 - W 47 X D 29 cm
ROCK 2 - W 57 X D 29 cm



ROSE
ROSE 1 - W 51 X D 33 cm
ROSE 2 - W 77 X D 33 cm



PORCELAIN STONE / GRES PORCELLANATO TOP H 1,2/ 12 CM

COLOURED GLASS / VETRO COLORATO TOP H 1,2 CM

COUNTERTOP WASHBASINS SELECTION

Selezione lavabi da appoggio

MATT WHITE CERAMIC / CERAMICA BIANCO OPACO



AURORA
Ø 40 cm X H 20 cm



SARAH
W 60 X D 36 X H 12 cm

GLOSSY WHITE CERAMIC / CERAMICA BIANCO LUCIDO



AMY
W 55 X D 42 X H 13 cm



LISA
W 60 X D 42 X H 14 cm

MATT WHITE PUREFEEL / PUREFEEL BIANCO OPACO



MARY
W 52,5 X D 33,5 X H 14 cm



JULIA
Ø 42 X H 14 cm



MATT WHITE LIGHTFEEL / LIGHTFEEL BIANCO OPACO



LEAF
W45 x D45 x H 12 cm



VOLCANO
W 54,5 X D 40 x H 15 cm



AVAILABLE IN ALL THE MATT FINISHES FROM THE OASIS COLOR SAMPLES / DISPONIBILE IN TUTTE LE FINITURE OPACHE DELLA MAZZETTA COLORI OASIS

BATHTUBS Collection

Vasche da bagno

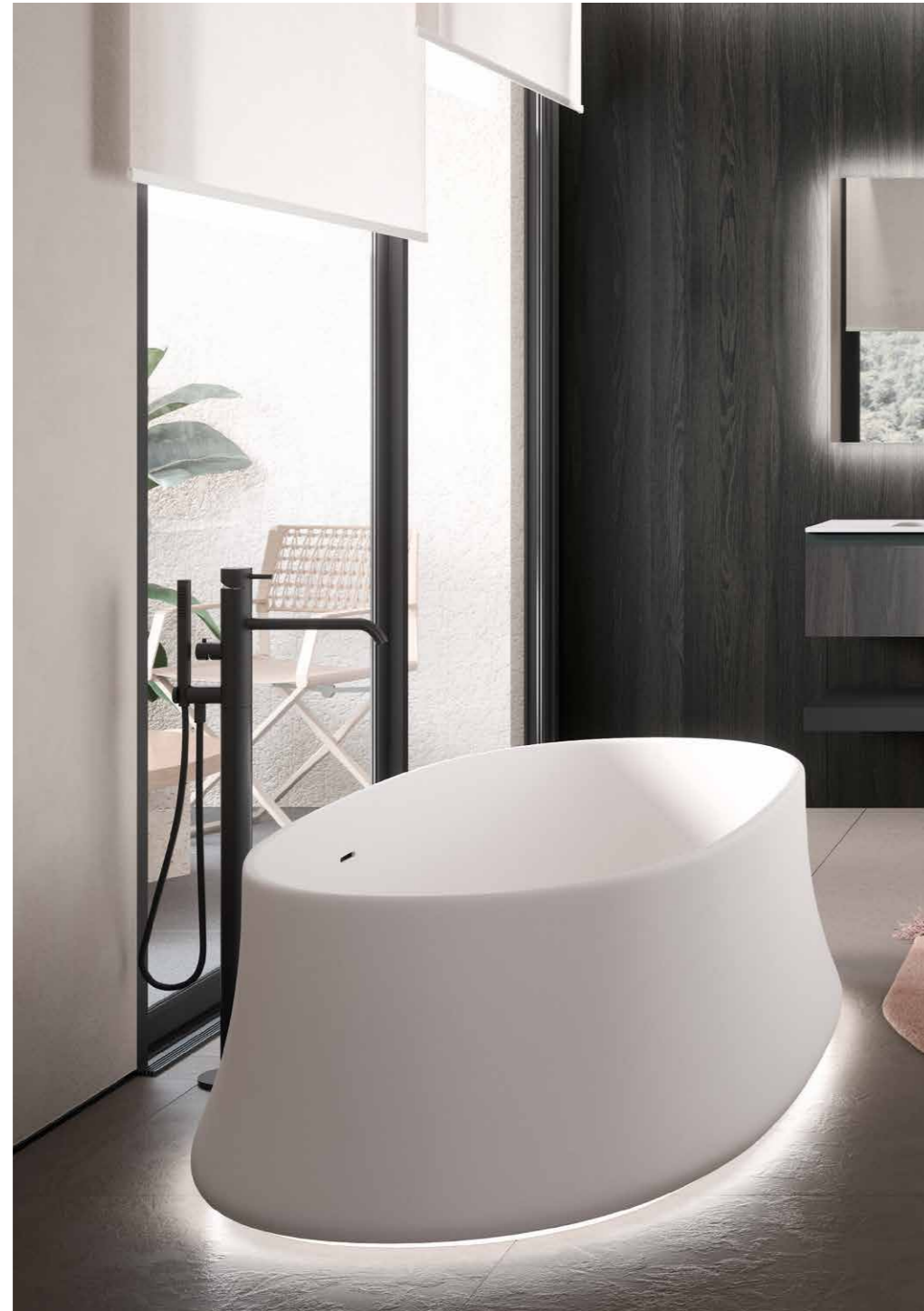

ALL BATHTUBS ARE AVAILABLE WITH MATT COLORED FINISH FROM THE OASIS COLOR SAMPLES /
TUTTE LE VASCHE DA BAGNO SONO DISPONIBILI IN FINITURA COLORATA OPACA DELLA MAZZETTA COLORI OASIS

MATT WHITE PUREFEEL / PUREFEEL BIANCO OPACO



HAMAL
W 160 X D 80 X H 55 cm



RIGEL
W 170 X D 70 X H 55 cm

MATT WHITE LIGHTFEEL / LIGHTFEEL BIANCO OPACO



HYDRA
W 175 X D 75 X H 52 cm



VEGA
W 158 X D 77 X H 59 cm



SIRIO
W 170 X D 80 X H 50 cm



MIZAR
W 180 X D 75 X H 50 cm



VOLCANO
W 186 X D 96 X H 50 cm

SYDNEY SANITARY WARE Collection

Sanitari SIDNEY



SIDNEY wall-hung version - CERAMIC
 SIDNEY versione sospesa in CERAMICA



WC
 W 37 X D 55 X H 35,5 cm



BIDET
 W 37 X D 55 X H 35,5 cm

SIDNEY back-to-wall version - CERAMIC
 SIDNEY versione a terra in CERAMICA



WC
 W 37 X D 55 X H 41 cm



BIDET
 W 37 X D 55 X H 41 cm

*AVAILABLE IN GLOSSY AND MATT WHITE CERAMIC
 *DISPONIBILE IN CERAMICA BIANCA LUCIDA E OPACA

STILO taps Collection

Rubineria STILO



STILO TAPS COLLECTION / RUBINETTERIA STILO



Deck mounted single lever basin mixer H 165 mm
Miscelatore per lavabo H 165 mm

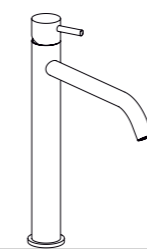

Deck mounted single lever basin mixer H 350 mm
Miscelatore per lavabo da appoggio H 350 mm

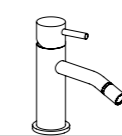

Deck mounted bidet mixer with adjustable spout
Miscelatore per bidet con bocca di erogazione orientabile



Deck mounted single lever basin mixer
Miscelatore monocomando per lavabo da appoggio

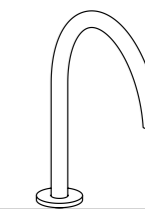

Deck mounted spout H 244 mm
Bocca di erogazione H 244 mm

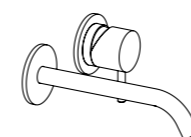

Wall mounted mixer with spout P 160 mm
Miscelatore a parete con bocca di erogazione P 160 mm

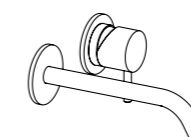

Wall mounted mixer with spout P 200 mm
Miscelatore a parete con bocca di erogazione P 200 mm

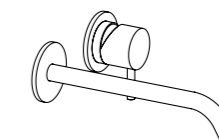

Wall mounted mixer with spout P 250 mm
Miscelatore a parete con bocca di erogazione P 250 mm

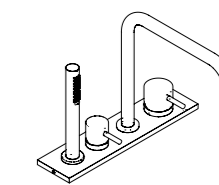

Rim mounted set of 2 mixers with spout and hand shower
Gruppo di 2 miscelatori bordo vasca con bocca di erogazione e doccia

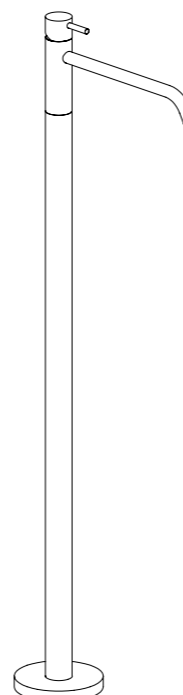

Freestanding single lever mixer for washbasin
Miscelatore lavabo da terra

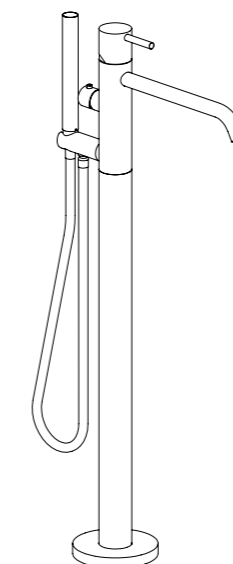

Freestanding bath mixer
Miscelatore vasca da terra

AVAILABLE FINISHES/FINITURE DISPONIBILI



Glossy steel / acciaio lucido



Brushed Steel / acciaio spazzolato



Brushed Black / nero spazzolato



Brushed Gold / oro spazzolato

MIRRORS Collection

Specchiere



EASY
Mirror with aluminum finish frame
Specchio con telaio in finitura alluminio
W 60/70/80/90/105/120/140/160/180 X H 80 cm

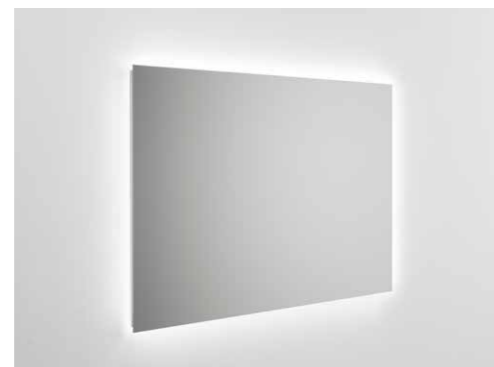

DALÌ FULL
Polished edge mirror complete with LED lighting on 4 sides. Without switch.
Specchio a filo lucido completo di illuminazione led sui 4 lati. Senza interruttore.
W from 60 to 245 X H 60/80/105 cm

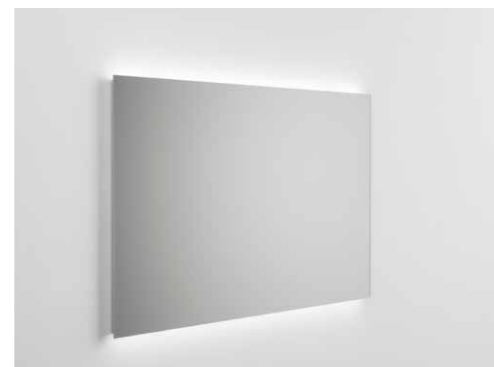

DALÌ UP & DOWN
Polished edge mirror complete with upper and lower LED lighting. Without switch.
Specchio a filo lucido completo di illuminazione led superiore ed inferiore. Senza interruttore.
W from 60 to 245 X H 60/80/105 cm



MIRÒ
Mirror with aluminum frame in matt white or black finish. Complete with LED lighting in the upper part and touch switch.
Specchio con telaio in alluminio in finiture bianco o nero opaco. Completo di illuminazione led nella parte superiore ed interruttore touch.
W 70/80/90/105/120/140/160 X H 80 cm



FREUD
Mirror with LED backlighting and touch switch with on/off dimmer function
Specchio con retro illuminazione a Led ed interruttore touch con funzione on /off dimmer
W 50 X H 100 cm



HUGO
Oval mirror with LED backlighting and touch switch with on / off dimmer function
Specchio ovale con retroilluminazione a led completo di interruttore a sfioramento con funzione on / off dimmer
W 50 X H 110 cm



JUNG
Mirror with LED backlighting and touch switch with on/off dimmer function
Specchio con retro illuminazione a Led ed interruttore touch con funzione on /off dimmer
W 80 X H 80 cm



ROMA
Mirror with external panel and perimeter in smoked mirror. Complete with LED backlighting and touch switch.
Specchio con pannello esterno e perimetro in specchio fumé. Completo di retro illuminazione a Led ed interruttore touch.
W 90X90 / 105X105 CM



KANT
Mirror with LED backlighting and touch switch with on/off dimmer function
Specchio con retro illuminazione a Led ed interruttore touch con funzione on /off dimmer
W 40 X H 80 cm / W 80 X H 160 cm

MIRRORS Collection

Specchiere

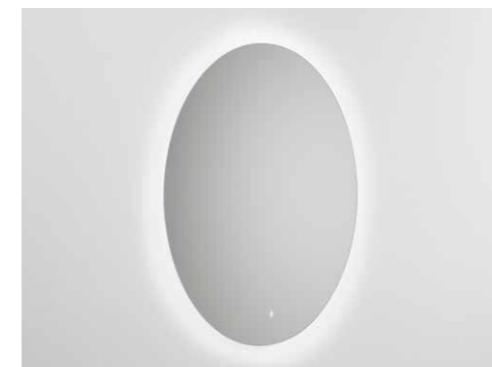

JOYCE
Mirror with LED backlighting and touch switch with on/off dimmer function
Specchio con retro illuminazione a Led ed interruttore touch con funzione on /off dimmer
Ø 80 / Ø 120 cm



DENIS
Mirror with matt white aluminum frame with LED backlighting. Complete with touch switch with on / off dimmer function and warm / cold light regulator.
Specchio con telaio in alluminio bianco opaco con retro illuminazione a Led . Completo di interruttore touch con funzione on /off dimmer e regolatore di luce calda /fredda.
Ø 71,2 / Ø 91,2 cm



DREAM
Mirror with black aluminum frame with LED backlighting. Without switch.
Specchio con telaio in alluminio nero con retro illuminazione a Led . Senza interruttore.
Ø 65 / Ø 90 cm



PARIS ROUND
Round mirror with 2 led lamps in black finishing, without switch
Specchio rotondo completo di 2 lampade Led in finitura nera, senza interruttore
Ø 80 / Ø 120 cm



PARIS SQUARE
Rectangular mirror with 2 led lamps in black finishing, without switch
Specchio rettangolare completo di 2 lampade Led in finitura nera, senza interruttore
H 80 cm

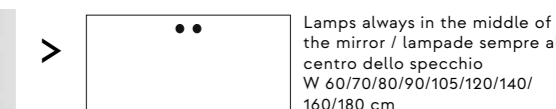

Lamps always in the middle of the mirror / lampade sempre al centro dello specchio
W 60/70/80/90/105/120/140/160/180 cm

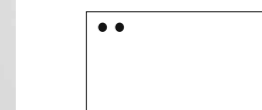

Lamps always on the left of the mirror / lampade sempre alla sinistra dello specchio
W 105/120/140/160/180 cm

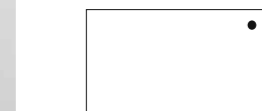

Lamps always on the right of the mirror / lampade sempre alla destra dello specchio
W 105/120/140/160/180 cm



PARIS SQUARE
Rectangular mirror with 4 led lamps in black finishing, without switch
Specchio rettangolare completo di 4 lampade Led in finitura nera, senza interruttore
H 80 cm

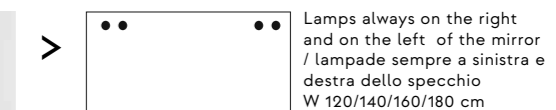

Lamps always on the right and on the left of the mirror / lampade sempre a sinistra e destra dello specchio
W 120/140/160/180 cm

MIRRORS Collection

Specchiere

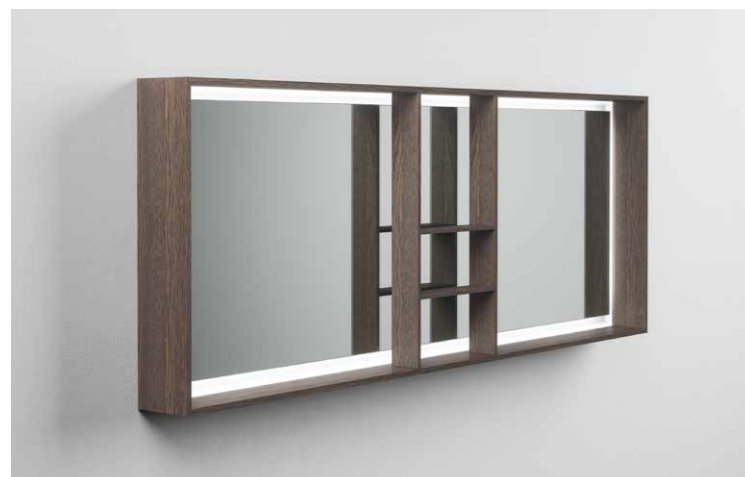

ACCA
Rectangular mirror with perimeter and central shelves lacquered or in wood, complete with led lighting and touch switch with on/off dimmer function
Specchio rettangolare con mensole perimetrali e centrali laccate o in essenza, completo di illuminazione led ed interruttore a sfioramento con funzione on/off dimmer

W 120/140/160/180/210 X D15 X H 80 cm



CHARLES
Rectangular mirror with lacquered or wooden perimeter shelves, complete with LED lighting and touch switch with on/off dimmer function
Specchio rettangolare con mensole perimetrali laccate o in essenza, completo di illuminazione led ed interruttore a sfioramento con funzione on/off dimmer

W 60/70/80/90/105/120 X D15 X H 80 cm



SCREEN
Mirror with 45° lacquered frame. Complete with LED backlighting and touch switch with on / off dimmer function.
Specchio con telaio laccato a 45°. Completo di retro illuminazione a Led ed interruttore touch con funzione on /off dimmer.

W 70/80/90/105/120/140/160/180 X H 80 cm



ALEX
Mirror with matt black aluminum frame with integrated LED lighting on the 4 internal sides. Complete with touch switch.
Specchio con telaio in alluminio nero opaco con illuminazione led integrata sui 4 lati interni. Completa di interruttore touch.

W 80/105/120/140 X H 70 cm

MIRRORS Collection

Specchiere



MY SUN
Mirror with lacquered or wooden frame. Complete with LED backlighting and touch switch with on / off dimmer function.
Specchio con telaio laccato o in essenza. Completo di retro illuminazione a Led ed interruttore touch con funzione on /off dimmer.

W 70/80/90/105/120/140/160/180 X H 80 cm

MIRROR CABINET / SPECCHIO CONTENITORE



NEW VICTORIA
Mirror cabinet with 2/3 external/internal mirrored doors with LED lighting, socket and switch.
Specchio contenitore con 2/3 ante a specchio esterno/interno con illuminazione a Led, presa ed interruttore, incasso murale.

W 60/70/85/105/120/140 X H 80 cm



VOLTAIRE
Mirror cabinet with 2/3 external/internal mirrored doors complete with perimeter LED lighting, socket, and switch.
Specchio contenitore con 2/3 ante a specchio esterno/interno completo di illuminazione perimetrale a LED presa e interruttore

W 60/70/80/90/105/120/140 X H 80 cm

DEFILÈ Accessories Collection

Defilè Accessori

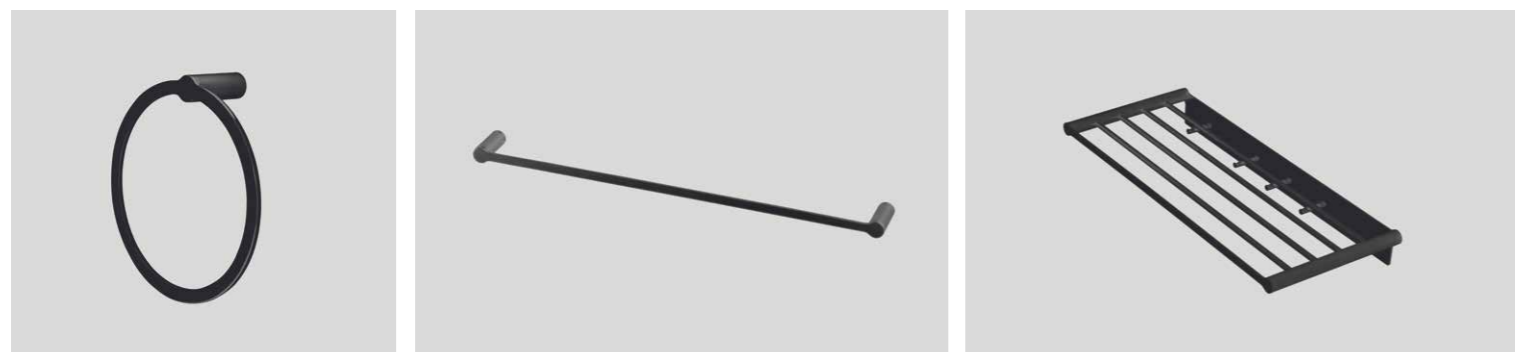

RING TOWEL HOLDER / PORTASALVIETTE AD ANELLO

TOWEL RAIL / BARRA PORTASALVIETTE

BATHTUBE TOWEL RACK / GRIGLIA PORTASALVIETTE PER VASCA



DOUBLE HOOK / APPENDINO DOPPIO

HOOK / APPENDINO

SHOWER SHELF / MENSOLA DOCCIA

TRAY / VASSOIO



WALL MOUNTED PAPER ROLL HOLDER / PORTA-ROTOLO DA PARETE

WALL MOUNTED SPARE PAPER ROLL HOLDER / PORTA-ROTOLO MULTIPOLO DA PARETE

WALL MOUNTED BRUSH HOLDER / PORTA-SCOPINO DA PARETE

FREE STANDING BRUSH HOLDER / PORTA-SCOPINO DA TERRA

WASTE BIN / GETTACARTA

DEFILÈ Accessories Collection

Defilè Accessori



TUMBLER / BICCHIERE

RAZOR HOLDER / PORTA RASOIO

TOOTHBRUSH HOLDER / PORTA SPAZZOLINI

WALL MOUNTED TUMBLER / BICCHIERE DA PARETE

WALL MOUNTED RAZOR HOLDER / PORTA RASOIO DA PARETE

WALL MOUNTED TOOTHBRUSH HOLDER / PORTA SPAZZOLINI DA PARETE



SOAP DISPENSER / DOSASAPONE

SMOOTH SOAP HOLDER / PORTA SAPONE LISCIO

KNURLED SOAP HOLDER / PORTA SAPONE GODRONATO

KLEENEX HOLDER / PORTA KLEENEX



SMOOTH SMALL BOX / SCATOLA LISCIA BASSA

KNURLED SMALL BOX / SCATOLA LISCIA BASSA GODRONATA

SMOOTH LARGE BOX / SCATOLA LISCIA ALTA

KNURLED LARGE BOX / SCATOLA LISCIA ALTA GODRONATA

MAGNIFYING MIRROR / SPECCHIO INGRANDITORE

AVAILABLE FINISHES / FINITURE DISPONIBILI



Chrome Cromo

Matt black Nero opaco

Gold Oro

LAMPS Collection

Collezione Lampade



LAMPS Collection

Collezione Lampade

LAMPS ON THE MIRROR / LAMPADE SULLO SPECCHIO

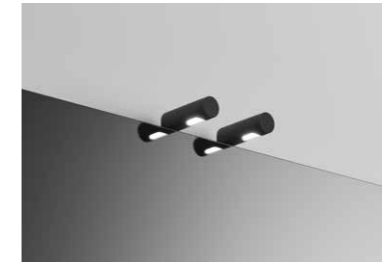

TOOBE - 2 x 5W
Ø 3,8 X D 12 cm

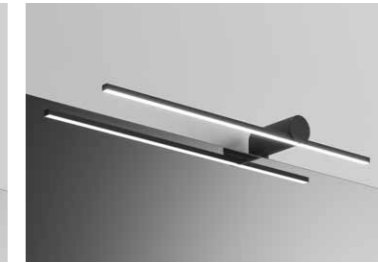

TETRIS DX - 13W
W 72,5 X D 13 X H 6 cm

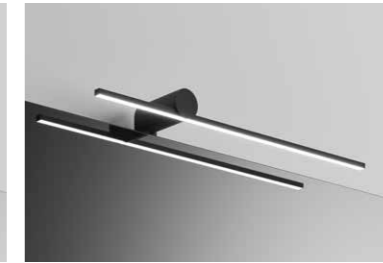

TETRIS SX - 13W
W 72,5 X D 13 X H 6 cm

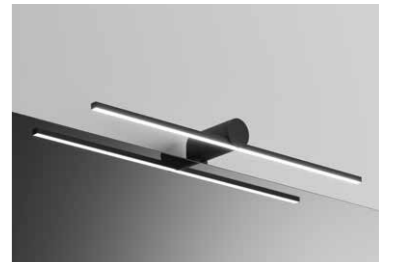

TETRIS - 13W
W 72,5 X D 13 X H 6 cm



LUME DX/SX - 6,2W
W 12 X D 16 X H 39 cm

WALL LAMPS / LAMPADE A PARETE



TETRIS DX - 13W
W 72,5 X D 13 X H 6 cm

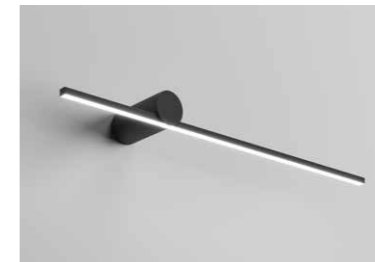

TETRIS SX - 13W
W 72,5 X D 13 X H 6 cm

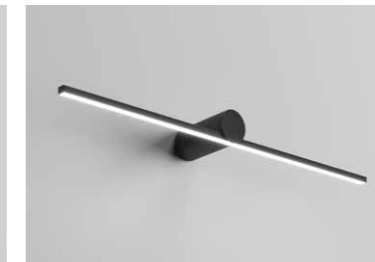

TETRIS - 13W
W 72,5 X D 13 X H 6 cm



LUME DX/SX - 6,2W
W 12 X D 16 X H 39 cm

SUSPENDED LAMPS / LAMPADE SOPPESE



SEI - 2 x 14W
Bronze finishing / Finitura bronzo
W 100 X D3 X H 2,6 cm



LUME - 6,2W
W 12 X D 12 X H 20 cm

ALL LAMPS ARE AVAILABLE IN MATT BLACK FINISH EXCEPT FOR "SEI LAMP" WHICH IS AVAILABLE IN BRONZE FINISH / TUTTE LE LAMPADE SONO DISPONIBILI IN FINITURA NERO OPACO AD ECCEZIONE DELLA "LAMPADA SEI" CHE È DISPONIBILE IN FINITURA BRONZATA

FINISHING

Finiture

LACQUERED FINISHES / LACCATI

Forever								
	G/M 0050 Bianco ghiaccio	G/M 0051 Bianco latte	G/M 0058 Papiro	G/M 0052 Corda elegance	G/M 0053 Sabbia	G/M 0054 Tortora elegance	G/M 0074 Ciclamino	G/M 0075 Orchidea
	G/M 0055 Avana	G/M 0083 Beige Arizona	G/M 0065 Nuvola	G/M 0059 Grigio elegance	G/M 0078 Grey	G/M 0079 Trim Grey	G/M 0080 Green	G/M 0076 Castoro
	G/M 0063 Verde salice	G/M 0056 Caffè elegance	G/M 0068 Blu notte	G /M 0066 Bluette	G/M 0077 London Grey	G/M 0057 Fango	G/M 0064 Verde muschio	G /M 0060 Grigio pietra
	G/M 0082 Grigio Bromo	G/M 0067 Blu elegance	G/M 0069 Blu oltremare	G/M 0061 Antracite dark	G/M 0062 Nero Lavagna	G/M 0081 Rosso Jaipur	G/M 0072 Ruggine	G/M 0073 Rosso Vivo
	G/M 0071 Arancio Acero	G/M 0070 Giallo Senape						

G CODE > INDICATES GLOSSY LACQUERED / INDICA LACCATO LUCIDO
 M CODE > INDICATES MATT LACQUERED / INDICA LACCATO OPACO
 D CODE > INDICATES GLOSSY METALLIC / INDICA METALLIZZATO LUCIDO

GLOSSY METALLIC / LACCATI METALLIZZATI

D0001 Prosecco	D0005 Light Grey	D0003 BRONZE	D0002 Gold	D0004 Gianduia	D0006 Dark Grey

FINISHING

Finiture

WOOD / LEGNI TOP / TOP

E0022 White Chestnut	E0019 Carved Oak	E0006 Sand Oak	E0024 Hemp Chestnut	E0023 Grey Chestnut	E0020 Carved Walnut	E0012 Walnut	EP002 Makassar
EP003 Dark Mahogany	EP001 Ammara Ebony	E0025 Black Chestnut	E0026 Heat Treated Oak	E0027 Charcoal Oak	E0028 Eucalyptus		

MELAMINE WOOD / NOBILITATI WOOD FINISHES / FINITURE LEGNO

N0001 Natural Oak	N0002 Acorn	N0003 Ash Oak	N0004 Lava Oak

COLOURED MELAMINE / NOBILITATI COLOURED FINISH / FINITURA COLORATA

N0005 Pure white	N0006 Corda	N0007 Caffè	N0008 Grafite	N0009 Iron grey	N0010 Sky	N0011 Deep dark

FINISHING

Finiture

COLOURED GLASS / VETRI COLORATI TOP / TOP

Forever								
VL/VS 050	VL/VS 051	VL/VS 058	VL/VS 052	VL/VS 053	VL/VS 054	VL/VS 074	VL/VS 075	
Bianco ghiaccio	Bianco latte	Papiro	Corda elegance	Sabbia	Tortora elegance	Ciclamino	Orchidea	
VL/VS 055	VL/VS 083	VL/VS 065	VL/VS 059	VL/VS 078	VL/VS 079	VL/VS 080	VL/VS 076	
Avana	Beige Arizona	Nuvola	Grigio elegance	Grey	Trim Grey	Green	Castoro	
VL/VS 063	VL/VS 056	VL/VS 068	VL/VS 066	VL/VS 077	VL/VS 057	VL/VS 064	VL/VS 060	
Verde salice	Caffè elegance	Blu notte	Bluette	London Grey	Fango	Verde muschio	Grigio pietra	
VL/VS 082	VL/VS 067	VL/VS 069	VL/VS 061	VL/VS 062	VL/VS 081	VL/VS 072	VL/VS 073	
Grigio Bromo	Blu elegance	Blu oltremare	Antracite dark	Nero Lavagna	Rosso Jaipur	Ruggine	Rosso Vivo	
VL/VS 071	VL/VS 070							
Arancio Acero	Giallo Senape							
VD 001	VD 002	VD 004	VD 005	VD 006	VD 003			
Prosecco	Gold	Bronze	Gianduia	Light grey	Dark grey			

VL CODE > INDICATES GLOSSY / INDICA LUCIDO
 VS CODE > INDICATES MATT / INDICA OPACO
 VD CODE > INDICATES GLOSSY METALLIC / INDICA METALLIZZATO LUCIDO

FINISHING

Finiture

PORCELAIN STONE / GRES TOP / TOP

B0009	B0010	B0011	B0012	B0013	B0014	B0008	B0015
Statuarietto	Sale	Pietra Piasentina	Pietra Grey Opaco	Fokos roccia	Jatoba brown	Noir desir	Alaska white

FENIX NTM® - TOP / TOP

FX001	FX005	FX007	FX012	FX002	FX003	FX011	FX008
White	Grey	Green	Grigio Bromo	Castoro	London Grey	Rosso Jaipur	Black

FINISHING

Finiture

WHITE/COLOURED MATT PUREFEEL / BIANCO/COLORATO OPACO PUREFEEL TOP / TOP

Forever

Bianco ghiaccio	Bianco latte	Papiro	Corda elegance	Sabbia	Tortora elegance	Ciclamino	Orchidea
Avana	Beige Arizona	Nuvola	Grigio elegance	Grey	Trim Grey	Green	Castoro
Verde salice	Caffé elegance	Blu notte	Bluette	London Grey	Fango	Verde muschio	Grigio pietra
Grigio Bromo	Blu elegance	Blu oltremare	Antracite dark	Nero Lavagna	Rosso Jaipur	Ruggine	Rosso Vivo
Arancio Acero	Giallo Senape						

CORIAN® TOP / TOP



Matt White
Bianco opaco

GEACRIL TOP / TOP



Glossy White
Bianco lucido

FINISHING

Finiture

WHITE/COLOURED MATT LIGHTFEEL / BIANCO/COLORATO OPACO LIGHTFEEL TOP / TOP

Bianco ghiaccio	Bianco latte	Papiro	Corda elegance	Sabbia	Tortora elegance	Ciclamino	Orchidea
Avana	Beige Arizona	Nuvola	Grigio elegance	Grey	Trim Grey	Green	Castoro
Verde salice	Caffé elegance	Blu notte	Bluette	London Grey	Fango	Verde muschio	Grigio pietra
Grigio Bromo	Blu elegance	Blu oltremare	Antracite dark	Nero Lavagna	Rosso Jaipur	Ruggine	Rosso Vivo
Arancio Acero	Giallo Senape						

COMPOSITIONS

Composizioni



FOREVER_001
P. 08_21



FOREVER_002
P. 22_35



FOREVER_003
P. 36_47



FOREVER_007
P. 86_95



FOREVER_008
P. 96_105



FOREVER_009
P. 106_117



FOREVER_004
P. 48_57



FOREVER_005
P. 58_73



FOREVER_006
P. 74_85



FOREVER_010
P. 118_127



FOREVER_011
P. 128_139



FOREVER_012
P. 140_149

COMPOSITIONS

Composizioni