



liscia ○

a **telaiio**

smooth or frame



smart

18 MILLIMETRI: È SU QUESTO SPESSORE CHE SI GIOCA LA SCELTA TRA LE ANTE A TELAIO PROPRIE DI SMART O LE LISCE DI TABLET E MIXARLE INSIEME. UNA SCELTA CHE DÀ UNA VALENZA NUOVA AL PROGETTO CUCINA CHE SI DEFINISCE SEMPRE PIÙ PERSONALIZZATO.

il piacere di mixare
è **smart**

LE TANTISSIME FINITURE DISPONIBILI, SIA DI SMART SIA DI TABLET DA MIXARE A LORO VOLTA, OFFRONO LA POSSIBILITÀ DI **CREARE UN MODELLO UNICO**, FATTO SU MISURA PER LE ESIGENZE E SECONDO I GUSTI DI OGNUNO. PIÙ SMART DI COSÌ!

**TAB
LET.**

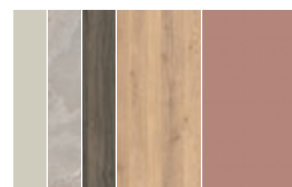

The pleasure of mixing is **smart**

18 Millimeters: it is on this thickness that **the choice is made between the framed doors featured in smart or the smooth ones characterizing tablet, as well as the possibility to mix them together.** A choice that gives a new value to the kitchen project, making it more and more personalized.

The large range of finishes available, both in smart and in tablet, to be mixed in turn, offer the possibility to create a unique model, customized according to one's own needs and tastes. It couldn't be any smarter!

smart

Facile, adattabile, essenziale, in una parola Smart. È la nuova cucina Creo Kitchens le cui ante e finiture possono essere mixate con quelle di Tablet sia in versione Bridge che Neck. Smart nasce con le ante a telaio spessore 18 mm, lo stesso delle ante lisce di Tablet. Le innumerevoli finiture disponibili dell'uno e dell'altro modello possono essere intercambiabili. Ecco perchè si può sviluppare un progetto unico, creando un'alternanza di ante e di finiture ogni volta diverso, con accostamenti inediti e ricchezza di soluzioni funzionali capaci di integrarsi perfettamente tra loro.

Smart è una cucina in continua evoluzione e si identifica con lo stile di chi la sceglie e a cui piace l'idea di poter mixare, abbinare, alternare, reinterpretare, rivisitare. Diventa molto Smart, intelligente e divertente definire uno spazio cucina costruito su misura delle proprie esigenze e dei propri gusti! E questo grazie alla flessibilità progettuale di Creo Kitchens sempre più orientata alla massima personalizzazione dei prodotti e alla realizzazione di soluzioni originali.





CREO ECOLOGIC

IL GRUPPO LUBE HA SCELTO DI UTILIZZARE PER I COMPONENTI COSTITUENTI LE STRUTTURE DELLE CUCINE SOLO MATERIALE A BASSISSIMA EMISSIONE DI FORMALDEIDE: CONFORMI ALLO STANDARD F4STELLE SECONDO LA NORMA JIS, CERTIFICATO DAL MINISTERO GIAPPONESE, IL PIU' SEVERO IN MERITO ALLE NORMATIVE DI SALVAGUARDIA AMBIENTALE.

Regarding the production of its kitchen structure components, lube group has decided to only use materials featuring very low formaldehyde emissions complying with the 4-star standard, as defined by the jis regulation. This standard is certified by the japanese government-the most rigorous when it comes to environmental protection.

Easy, adaptable, pared-back - in a word, Smart. This is the new Creo Kitchens project with doors and finishes that can be combined with the Tablet ones, both in the Bridge and Neck version.

Smart has framed cabinetry which is 18-mm thick, the same as Tablet's frameless cabinetry.

The countless finishes available for both styles are interchangeable.

This is why it is so easy to put together a unique project, alternating doors and finishes to create a different look each time with a series of unusual combinations and a wealth of functional solutions that seamlessly integrate with each other.

Ever-evolving, Smart is a kitchen that reflects the taste of the home-owners and lends itself to mixing, matching, changing up, re-imagining and reworking. Defining a kitchen space which is tailored not only to your needs, but also to your individual tastes is a very fun, sensible and Smart thing to do! And now you can, thanks to the design flexibility offered by Creo Kitchens which is increasingly geared to full product customisation and to coming up with original solutions.



CARATTERISTICHE TECNICHE

ANTE E FRONTALI CASSETTI

anta sp. 18 mm a telaio in MDF certificato (conforme **US EPA TSCA Title VI**) rivestita in alkorcell effetto legno nei colori: frassino bianco alpino (opz.2310), rovere greige (opz.2320), betulla (opz.2311)

anta sp. 18 mm a telaio in MDF certificato (conforme **US EPA TSCA Title VI**) rivestita in PET opaco tinta unita nei colori: gesso supermatt (opz.7464), sahara supermatt (opz.7717), luna supermatt (opz.9610), carbone supermatt (opz.9613)

ANTE VETRO

anta sp. 18 a telaio in MDF certificato (conforme **US EPA TSCA Title VI**), rivestita in alkorcell effetto metallo spazzolato, vetro extrachiaro temperato 4 mm filo grezzo serigrafato trama tessuto in vernice satinata nei colori: metal lux (opz.2300), metal dark (opz.2309)

anta sp. 18 a telaio in MDF certificato (conforme **US EPA TSCA Title VI**), rivestita in PET opaco tinta unita, vetro extrachiaro temperato 4 mm filo grezzo serigrafato trama tessuto in vernice satinata nei colori: gesso supermatt (opz.7464), sahara supermatt (opz.7717), luna supermatt (opz.9610), carbone supermatt (opz.9613)

MANIGLIE

vedi pag.20

STRUTTURE DI SERIE

ANTE: FRASSINO BIANCO ALPINO, GESSO SUPERMATT
nobilitato bianco (opz.001), schiena e ripiano bianco (opz.001)

ANTA: SAHARA SUPERMATT
nobilitato conchiglia (opz.8910) schiena e ripiano conchiglia (opz.8910)

ANTA: CARBONE SUPERMATT
nobilitato lavagna (opz.9620) schiena e ripiano lavagna (opz.9620)

ANTE: ROVERE GREIGE, BETULLA
nobilitato visone (opz.948M) schiena e ripiano visone (opz.948M)

ANTA: LUNA SUPERMATT
nobilitato argilla (opz.9690) schiena e ripiano argilla (opz.9690)

a richiesta: nobilitato fango (opz.8860) schiena e ripiano fango (opz.8860)

STRUTTURE CONSIGLIATE

PER ANTE VETRO FINITURA ALKORCELL

ANTA VETRO: METAL LUX
nobilitato visone (opz.948M) schiena e ripiano visone (opz.948M)

ANTA VETRO: METAL DARK
nobilitato lavagna (opz.9620) schiena e ripiano lavagna (opz.9620)

MENSOLE

di serie: altezza 3,8 cm in laminato bianco (opz.001), conchiglia (opz.8910), fango (opz.8860), lavagna (opz.9620), visone (opz.948M), argilla (opz.9690)

a richiesta: altezza 3,8 cm finiture come ante

ZOCCOLI

vedi pag.22



TECHNICAL SPECIFICATIONS

| | |
|-------------------------------|--|
| DOORS AND DRAWER FRONT PANELS | <p>18-mm thick certified framed MDF door panel (compliant with US EPA TSCA Title VI) coated with wood-effect alkorcell in the following shades: alpine-white ash (opz.2310), greige oak (opz.2320), birch (opz.2311)</p> <p>18-mm thick certified framed MDF door panel (compliant with US EPA TSCA Title VI), coated with plain matt PET in the following shades: super-matt gypsum (opz.7464), super-matt sahara (opz.7717), super-matt moon (opz.9610), super-matt carbon (opz.9613)</p> |
| GLASS DOORS | <p>18-mm thick certified framed MDF door panel (compliant with US EPA TSCA Title VI), coated with brushed metal-effect alkorcell, extra-clear tempered glass, 4 mm, ground edges, screen-printed fabric pattern with satin-finish paint in the following shades: metal lux (opz.2300), dark metal (opz.2309)</p> <p>18-mm thick certified framed MDF door panel (compliant with US EPA TSCA Title VI), coated with plain matt PET, extra-clear tempered glass, 4 mm, ground edges, screen-printed fabric pattern with satin-finish paint in the following shades: super-matt gypsum (opz.7464), super-matt sahara (opz.7717), super-matt moon (opz.9610), super-matt carbon (opz.9613)</p> |
| HANDLES | <p>see page 20</p> |
| STANDARD STRUCTURES | <p>DOORS: ALPINE-WHITE ASH, SUPER-MATT GYPSUM melamine-faced white (opz.001), white back panel and shelf (opz.001)</p> <p>DOOR: SUPER-MATT SAHARA melamine-faced seashell (opz.8910), seashell back panel and shelf (opz.8910)</p> <p>DOOR: SUPER-MATT CARBON melamine-faced slate grey (opz.9620), slate-grey back panel and shelf (opz.9620)</p> <p>DOORS: GREIGE OAK, BIRCH melamine-faced mink (opz.948M), mink back panel and shelf (opz.948M)</p> <p>DOOR: SUPER-MATT MOON melamine-faced clay (opz.9690), clay back panel and shelf (opz.9690)</p> <p>on request: melamine-faced mud (opz.8860), mud back panel and shelf (opz.8860)</p> |
| RECOMMENDED STRUCTURES | <p>FOR GLASS DOORS WITH ALKORCELL FINISH</p> <p>GLASS DOOR: LUX METAL melamine-faced mink (opz.948M), mink back panel and shelf (opz.948M)</p> <p>GLASS DOOR: DARK METAL melamine-faced slate grey (opz.9620), slate-grey back panel and shelf (opz.9620)</p> |
| SHELVES | <p>standard: 3.8 cm thick, laminate, white (opz.001), seashell (opz.8910), mud (opz.8860), slate grey (opz.9620), mink (opz.948M), clay (opt.9690)</p> <p>on request: 3.8 cm thick, with the same finish as doors</p> |
| PLINTHS | <p>see page 22</p> |

smart

Neck cod. **KS2**

Bridge cod. **KS1**

ante finitura alkorcell effetto legno
alkorcell wood effect finish doors

 *colori in pronta consegna
available colours*



frassino bianco alpino (opz.2310)
alpine-white ash (opt.2310)



rovere greige (opz.2320)
greige oak (opt.2320)



betulla (opz.2311)
birch (opt.2311)

N.B.: disponibile a partire da Giugno 2021
Note: available from June 2021

SP. 18 MM TH.18 MM

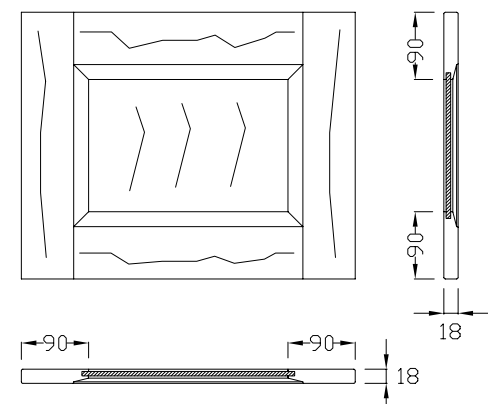

smart

Neck cod. **KS2**
Bridge cod. **KS1**

ante finitura PET opaco tinta unita
solid color matt PET finish doors



gesso supermatt (opz.7464)
super-matt gypsum (opt.7464)

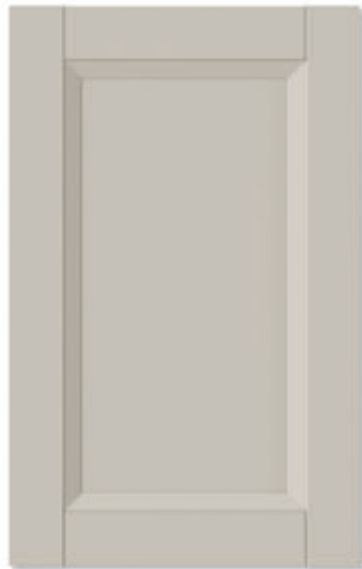

sahara supermatt (opz.7717)
super-matt sahara (opt.7717)

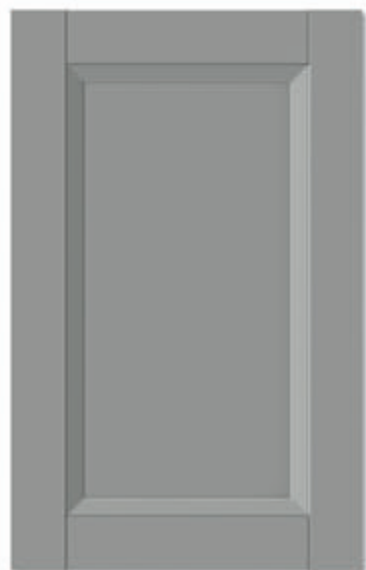

luna supermatt (opz.9610)
super-matt moon (opt.9610)



carbone supermatt (opz.9613)
super-matt carbon (opt.9613)

SP. 18 MM TH.18 MM

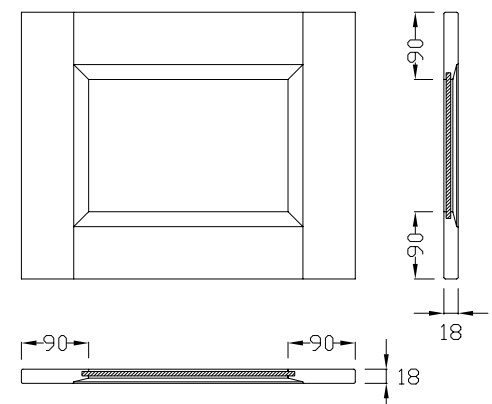

smart

Neck cod. **KS2**
Bridge cod. **KS1**

ante vetro finitura alkorcell effetto metallo spazzolato
glass doors alkorcell brushed metal effect finish

 *colori in pronta consegna
available colours*



metal lux (opz.2300)
finitura spazzolata con vetro
extrachiaro serigrafato, trama
tessuto in vernice satinata
metal lux (opt.2300)
brushed finish with extra-clear
screen-printed glass, fabric
pattern in satin-finish paint



metal dark (opz.2309)
finitura spazzolata con vetro
extrachiaro serigrafato, trama
tessuto in vernice satinata
dark metal (opt.2309)
brushed finish with extra-clear
screen-printed glass, fabric
pattern in satin-finish paint

SP. 18 MM TH.18 MM

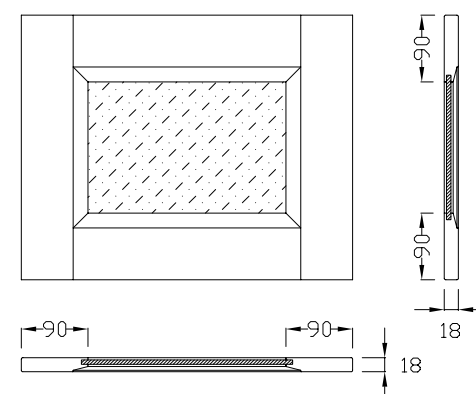

ante vetro finitura PET
glass doors PET finish



gesso supermatt (opz.7464)
vetro extrachiaro serigrafato,
trama tessuto in vernice satinata
super-matt gypsum (opz.7464)
extra-clear screen-printed glass,
fabric pattern in satin-finish paint



sahara supermatt (opz.7717)
vetro extrachiaro serigrafato,
trama tessuto in vernice satinata
super-matt sahara (opz.7717)
extra-clear screen-printed glass,
fabric pattern in satin-finish paint

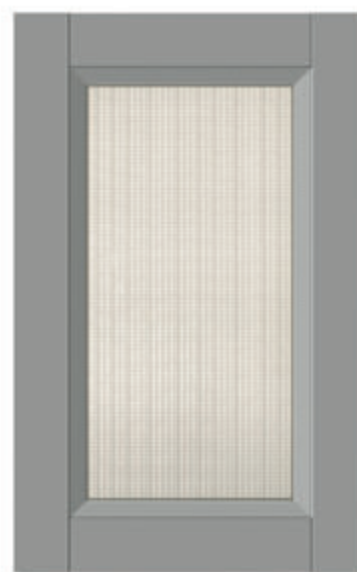

luna supermatt (opz.9610)
vetro extrachiaro serigrafato,
trama tessuto in vernice satinata
super-matt moon (opz.9610)
extra-clear screen-printed glass,
fabric pattern in satin-finish paint

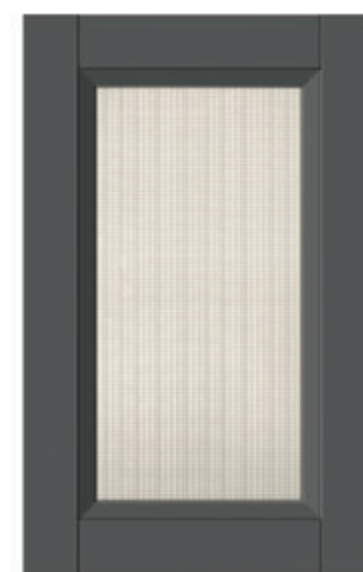

carbone supermatt (opz.9613)
vetro extrachiaro serigrafato,
trama tessuto in vernice satinata
super-matt carbon (opz.9613)
extra-clear screen-printed glass,
fabric pattern in satin-finish paint

Neck

FINITURE GOLE

FINITURE GOLE SPAZZOLATE
FINGER RAILS BRUSHED FINISHES

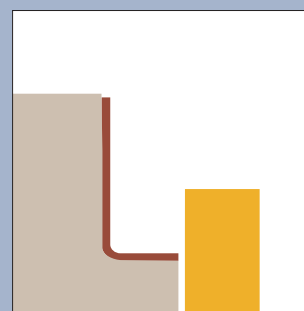
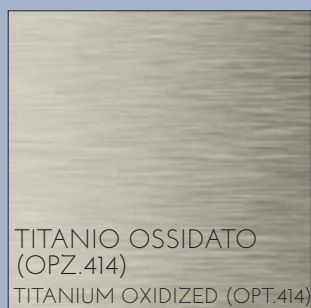
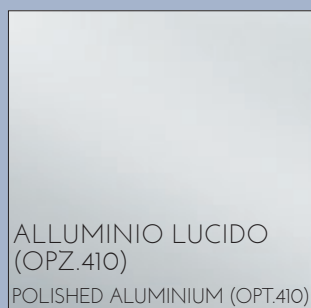



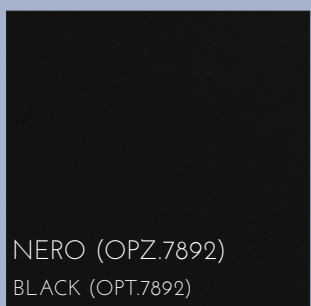
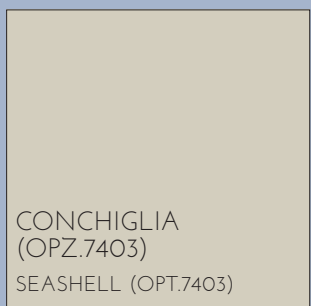
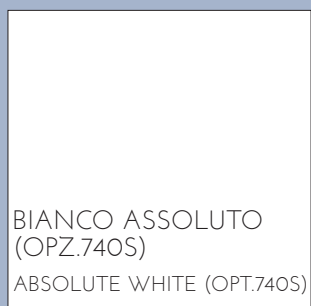

GOLA TIPO "ELLE"
"ELLE" TYPE FINGER RAIL

FINITURE GOLE VERNICIATE A POLVERE OPACHE
MATT FINGER RAILS POWDER COATED FINISHES



GOLA "ELLE" ORIZZONTALE SOTTOTOP

UNDERMOUNT HORIZONTAL "ELLE" FINGER RAIL

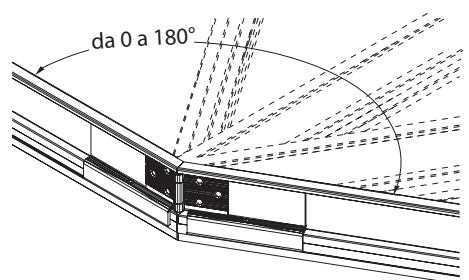
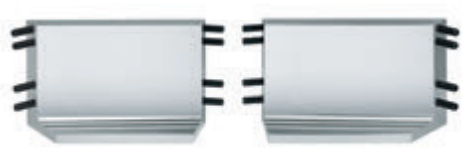







| | COD. | | | COD. | | |
|---|---------|--|--|---|---------|--|
| <p>Gola sottotop tipo "A" Type "A" undermount finger rail</p>  <p style="text-align: right;">al ml per lm</p> | G950010 | | | <p>Angolo interno a 90° per gola tipo "A" 90° interior corner for "A" type finger rail</p>  <p style="text-align: right;">cadauno each</p> | G950050 | |
| <p>Terminale aperto dx o sx per gola tipo "A" da utilizzare a fine composizione RH or LH open end for type "A" finger rail to be placed at the end of the composition</p>  <p style="text-align: right;">in alluminio aluminium</p> <p style="text-align: right;">terminale DX RH end</p> <p style="text-align: right;">terminale SX LH end</p> <p style="text-align: right;">in plastica (solo finitura opz.410) plastic (only finish opt.410)</p> <p style="text-align: right;">terminale DX RH end</p> <p style="text-align: right;">terminale SX LH end</p> | G950021 | | | <p>Angolare con snodo per unione fuori squadra per gola tipo "A" Corner piece with joint for out-of-plumb joining for type "A" finger rail</p>  | | |
| | G950022 | | | | | |
| | G950041 | | | | | |
| | G950042 | | | | | |
| <p>Terminale chiuso dx o sx per gola tipo "A" da utilizzare solo tra basi e colonne RH or LH closure for type "A" finger rail to be placed only between base units and column</p>  <p style="text-align: right;">in alluminio aluminium</p> <p style="text-align: right;">terminale DX RH end</p> <p style="text-align: right;">terminale SX LH end</p> <p style="text-align: right;">in plastica (solo finitura opz.410) plastic (only finish opt.410)</p> <p style="text-align: right;">terminale DX RH end</p> <p style="text-align: right;">terminale SX LH end</p> | G950031 | | |  <p style="text-align: center;">da 0 a 180°</p> | | |
| | G950032 | | | | | |
| | G950045 | | | | | |
| | G950046 | | | | | |
| <p>Coppia angolari per kit raccordo base angolo 110x110 Couple corner piece for fitting kit corner base unit 110x110</p>  <p style="text-align: center;">SX LH DX RH</p> <p style="text-align: right;">in alluminio aluminium</p> <p style="text-align: right;">angolare DX RH corner piece</p> <p style="text-align: right;">angolare SX LH corner piece</p> | G950058 | | | | G950060 | |
| | G950059 | | | | | |

GOLA "ELLE" ORIZZONTALE INTERMEDIA

INTERMEDIATE HORIZONTAL "ELLE" FINGER RAIL

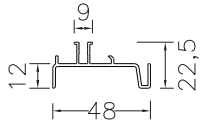
GOLE "ELLE" VERTICALI PER COLONNE

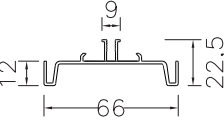
VERTICAL "ELLE" FINGER RAILS FOR COLUMNS

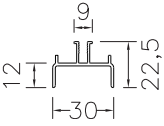
| | COD. | | | |
|--|--|--|--|--|
| <p>Gola intermedia tipo "B" Type "B" intermediate finger rail</p>  <p style="text-align: right;">al ml per lm</p> | G950110 | | | |
| <p>Terminale aperto dx o sx per gola tipo "B" da utilizzare a fine composizione RH or LH open end for type "B" finger rail to be placed at the end of the composition</p>  <p style="text-align: right;">in alluminio aluminium</p> <p style="text-align: right;">terminale DX RH end</p> <p style="text-align: right;">terminale SX LH end</p> <p style="text-align: right;">in plastica (solo finitura opz.410) plastic (only finish opt.410)</p> <p style="text-align: right;">terminale DX RH end</p> <p style="text-align: right;">terminale SX LH end</p> | G950121 G950122 G950141 G950142 | | | |
| <p>Terminale chiuso dx o sx per gola tipo "B" da utilizzare solo tra cassettiere e lavastoviglie/colonne RH or LH closure for type "B" finger rail to be placed only between drawer units and dishwasher/columns</p>  <p style="text-align: right;">in alluminio aluminium</p> <p style="text-align: right;">terminale DX RH end</p> <p style="text-align: right;">terminale SX LH end</p> <p style="text-align: right;">in plastica (solo finitura opz.410) plastic (only finish opt.410)</p> <p style="text-align: right;">terminale DX RH end</p> <p style="text-align: right;">terminale SX LH end</p> | G950131 G950132 G950145 G950146 | | | |
| | | | | |
| <p>Mezza gola verticale tipo "C" (completa di distanziale) Type "C" half vertical finger rail (complete with spacer)</p>   <p style="text-align: center;">sezione mezza gola tipo "C" cross section of type "C" finger rail</p> <p style="text-align: right;">pie di H 13 feet H 13</p> <p style="text-align: right;">H 96</p> <p style="text-align: right;">H 132</p> <p style="text-align: right;">H 204</p> <p style="text-align: right;">H 228</p> | G950310 G950330 G950350 G950370 | | | |
| <p>Gola verticale intermedia tipo "D" (completa di distanziale) Type "D" intermediate vertical finger rail (complete with spacer)</p>   <p style="text-align: center;">sezione gola tipo "D" cross section of type "D" finger rail</p> <p style="text-align: right;">pie di H 13 feet H 13</p> <p style="text-align: right;">H 96</p> <p style="text-align: right;">H 132</p> <p style="text-align: right;">H 204</p> <p style="text-align: right;">H 228</p> | G950410 G950430 G950450 G950470 | | | |
| <p>Gola verticale laterale tipo "E" (completa di distanziale) Type "E" lateral vertical finger rail (complete with spacer)</p>   <p style="text-align: center;">sezione gola tipo "E" cross section of type "E" finger rail</p> <p style="text-align: right;">pie di H 13 feet H 13</p> <p style="text-align: right;">H 96</p> <p style="text-align: right;">H 132</p> <p style="text-align: right;">H 204</p> <p style="text-align: right;">H 228</p> | G950510 G950530 G950550 G950570 | | | |

NOZIONI UTILI - gole "elle" orizzontali per basi

USEFUL INFORMATION - HORIZONTAL "ELLE" FINGER RAILS FOR BASE UNITS

VISTA FRONTALE ZOCCOLO H 13 PER BASI H 88

FRONT VIEW PLINTH H 13 FOR BASE UNITS H 88

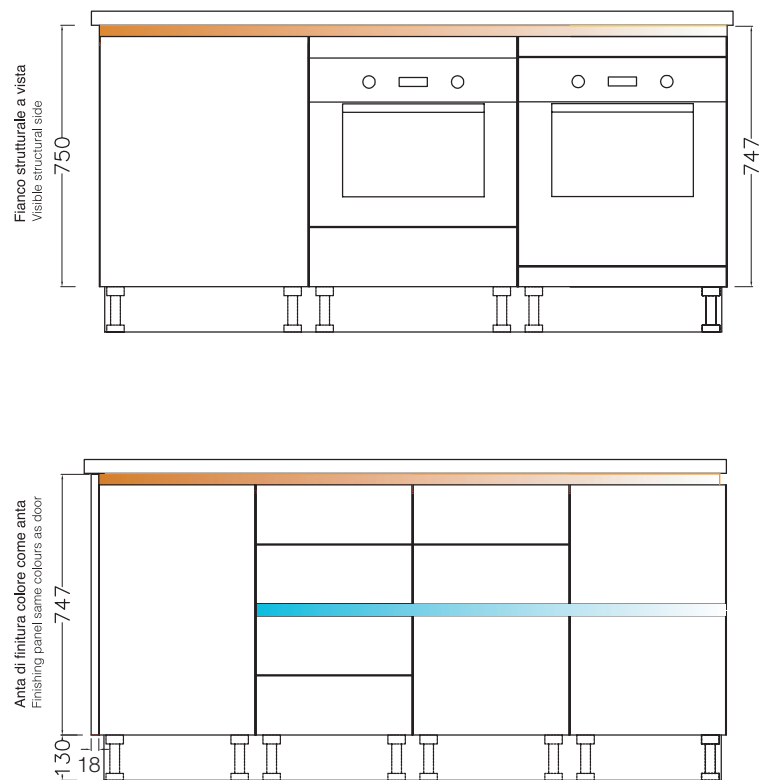

VISTA LATERALE (sezione) ZOCCOLO H 13 PER BASI H 88

SIDE VIEW (CROSS SECTION) PLINTH H 13 FOR BASE UNITS H 88

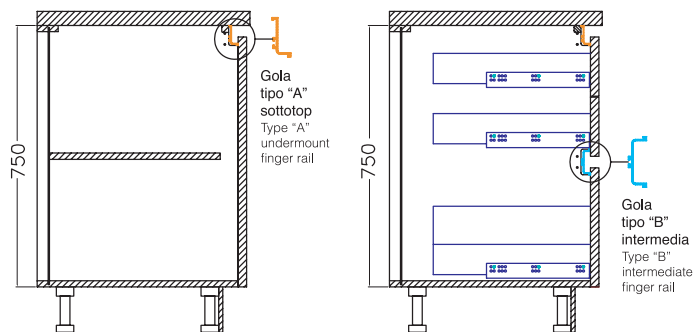

VISTA DALL'ALTO

TOP VIEW



Composizione con ante di finitura laterali: alla dimensione finale della cucina, sommare sempre lo spessore delle ante di finitura (ogni anta 18 mm)

Composition with side finishing panels: to the final size of the kitchen, always add the thickness of the finishing panels (each panel 18 mm)

NOZIONI UTILI - gole "elle" verticali per colonne

USEFUL INFORMATION - VERTICAL "ELLE" FINGER RAILS FOR COLUMNS

VISTA FRONTALE ZOCCOLO H 13

FRONT VIEW PLINTH H 13

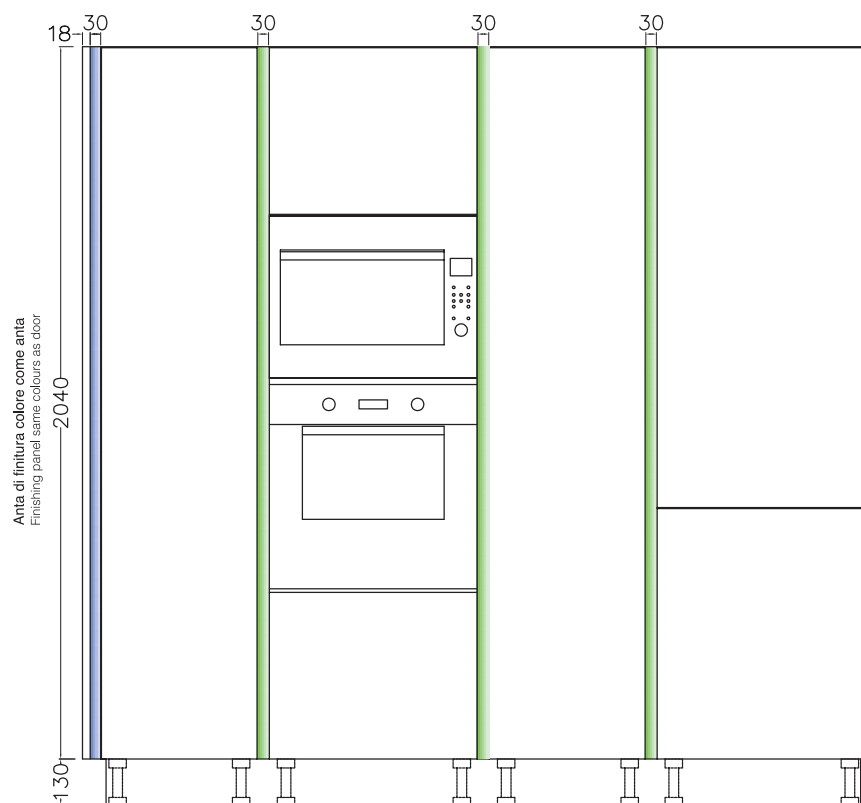

VISTA DALL'ALTO

TOP VIEW

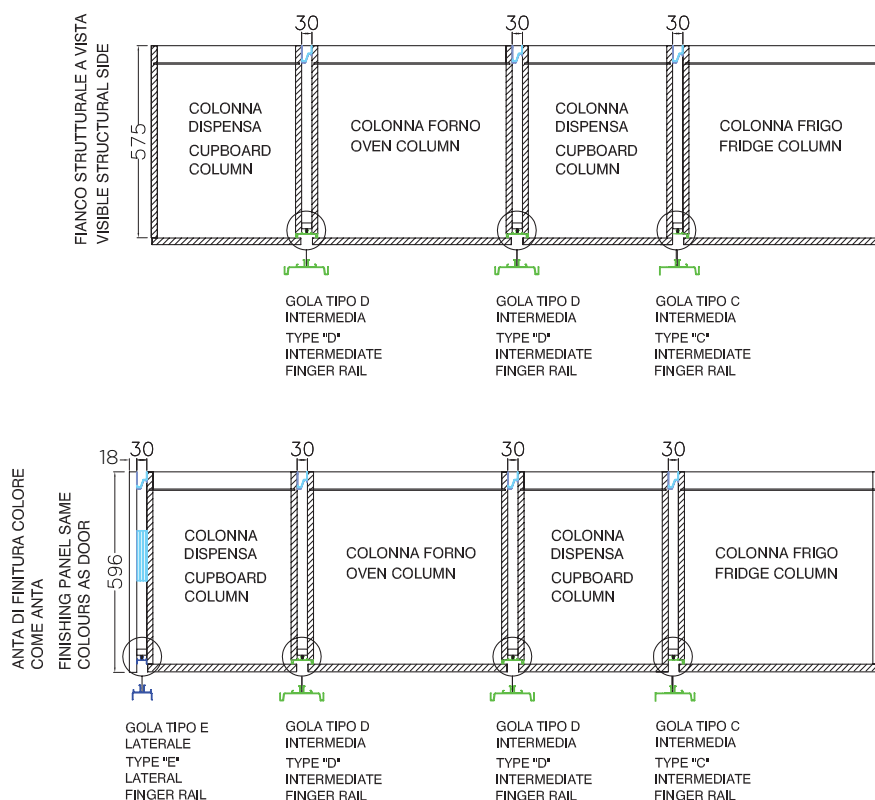

Composizione fianco strutturale a vista come anta: alla dimensione finale della cucina, sommare sempre lo spessore dei distanziali tra le colonne (ogni distanziale 3 cm)

Composition with visible side panel to match door: to the final size of the kitchen, always add the thickness of the spacers between the two columns (each spacer 3 cm)

Composizione con ante di finitura laterali, alla dimensione finale della cucina, sommare sempre lo spessore dei distanziali tra le colonne (ogni distanziale 3 cm) e lo spessore delle ante di finitura (ogni anta 18 mm)

Composition with side finishing panels to the final size of the kitchen, always add the thickness of the spacer between the two columns (each spacer 3 mm) and the thickness of the finishing panels (each panel 18 mm)

DI SERIE STANDARD



Maniglia K92 finitura grigio selce
 anta da L 15 a L 30 → passo 64 mm
 anta da L 40 a L 75 → passo 160 mm
 anta da L 90 a L 120 → passo 320 mm

Handle K92 flint grey finish
 door from W 15 to W 30 → centre-to-centre distance 64 mm
 door from W 40 to W 75 → centre-to-centre distance 160 mm
 door from W 90 to W 120 → centre-to-centre distance 320 mm

A RICHIESTA ON REQUEST



Maniglia K93 finitura ghisa
 anta da L 15 a L 30 → passo 64 mm
 anta da L 40 a L 75 → passo 160 mm
 anta da L 90 a L 120 → passo 320 mm

Handle K93 caston iron finish
 door from W 15 to W 30 → centre-to-centre distance 64 mm
 door from W 40 to W 75 → centre-to-centre distance 160 mm
 door from W 90 to W 120 → centre-to-centre distance 320 mm



Maniglia K94 finitura silver dark
 anta da L 15 a L 30 → pomo
 anta da L 40 a L 75 → passo 160 mm
 anta da L 90 a L 120 → passo 320 mm

Handle K94 dark silver finish
 door from W 15 to W 30 → knob
 door from W 40 to W 75 → centre-to-centre distance 160 mm
 door from W 90 to W 120 → centre-to-centre distance 320 mm



Maniglia K85 finitura cromo satinato
 anta da L 15 a L 30 → passo 96 mm
 anta da L 40 a L 75 → passo 160 mm
 anta da L 90 a L 120 → passo 320 mm

Handle K85 satin chrome finish
 door from W 15 to W 30 → centre-to-centre distance 96 mm
 door from W 40 to W 75 → centre-to-centre distance 160 mm
 door from W 90 to W 120 → centre-to-centre distance 320 mm



Maniglia K87 finitura nichel lux
 anta da L 15 a L 30 → passo 96 mm
 anta da L 40 a L 75 → passo 160 mm
 anta da L 90 a L 120 → passo 320 mm

Handle K87 lux nikel finish
 door from W 15 to W 30 → centre-to-centre distance 96 mm
 door from W 40 to W 75 → centre-to-centre distance 160 mm
 door from W 90 to W 120 → centre-to-centre distance 320 mm



Maniglia K90 finitura bronzo
 anta da L 15 a L 30 → passo 64 mm
 anta da L 40 a L 120 → passo 160 mm

Handle K90 bronze finish
 door from W 15 to W 30 → centre-to-centre distance 64 mm
 door from W 40 to W 120 → centre-to-centre distance 160 mm



MANIGLIE
HANDLES

smart

strutture carcasses



bianco (opz.001)
schiena e ripiano bianco
(opz.001)
white (opt.001)
white back panel and shelf
(opt.001)



conchiglia (opz.8910)
schiena e ripiano conchiglia
(opz.8910)
shell (opt.8910)
shell back panel and shelf
(opt.8910)



visone (opz.948M)
schiena e ripiano visone
(opz.948M)
mink (opt.948M)
mink back panel and shelf
(opt.948M)



fango (opz.8860)
schiena e ripiano fango
(opz.8860)
mud (opt.8860)
mud back panel and shelf
(opt.8860)



lavagna (opz.9620)
schiena e ripiano lavagna
(opz.9620)
slate grey (opt.9620)
slate grey back panel and shelf
(opt.9620)



argilla (opz.9690)
schiena e ripiano argilla
(opz.9690)
clay (opt.9690)
clay back panel and shelf
(opt.9690)



Il Gruppo LUBE è stata la prima azienda in Italia ad ottenere per le strutture delle sue cucine la Certificazione GREENGUARD Gold, che è garanzia della bassissima emissione di sostanze chimiche inquinanti COV.

Gruppo Lube was the first company in Italy achieving the GREENGUARD Gold Certification for its kitchen structures, which is a guarantee of the very low VOC polluting chemicals emission.



CREO ECOLOGIC

IL GRUPPO LUBE HA SCELTO DI UTILIZZARE PER I COMPONENTI COSTITUENTI LE STRUTTURE DELLE CUCINE SOLO MATERIALE A BASSISSIMA EMISSIONE DI FORMALDEIDE: CONFORMI ALLO STANDARD F**** SECONDO LA NORMA JIS, CERTIFICATO DAL MINISTERO GIAPPONESE. IL PIU' SEVERO IN MERITO ALLE NORMATIVE DI SALVAGUARDIA AMBIENTALE.

LUBE GROUP HAS CHOSEN TO EXCLUSIVELY USE MATERIALS WITH VERY LOW FORMALDEHYDE EMISSIONS FOR THE COMPONENTS MAKING UP THE KITCHEN CARCASSES: THESE ELEMENTS COMPLY WITH THE F4 STAR STANDARD ACCORDING TO JIS, CERTIFIED BY THE JAPANESE GOVERNMENT - THE MOST STRINGENT WHEN IT COMES TO ENVIRONMENTAL PROTECTION.

zoccoli in pvc H 13

pvc plinths H 13



acciaio (opz.407)
steel (opt.407)



alluminio satinato
(opz.405)
satin aluminium
(opt.405)



bianco (opz.001)
white (opt.001)

zoccoli in alluminio H 13

aluminium plinths H 13



alluminio liscio finitura
brill (opz.412)
smooth aluminium with
brill finish (opt.412)



alluminio finitura titanio
ossidato (opz.414)
aluminium titanium
oxidized finish (opt.414)

smart

zoccoli in alluminio H 13 verniciati a polvere finitura opaca
aluminum plinths H 13 powder coated matt finish



alluminio finitura bianco assoluto (opz.740S)
aluminium absolute white finish (opt.740S)



alluminio finitura grigio selce (opz.SE)
aluminium flint grey finish (opt.SE)



alluminio finitura silver dark (opz.9507)
aluminium dark silver finish (opt.9507)



alluminio finitura ghisa (opz.9509)
aluminium cast iron finish (opt.9509)

mensole in laminato laminate shelves



bianco (opz.001)
white (opt.001)



conchiglia (opz.8910)
shell (opt.8910)

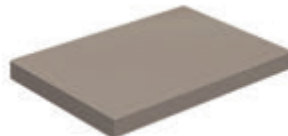

visone (opz.948M)
mink (opt.948M)



lavagna (opz.9620)
slate grey (opt.9620)

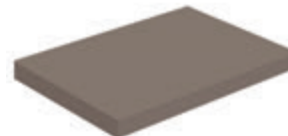

fango (opz.8860)
mud (opt.8860)

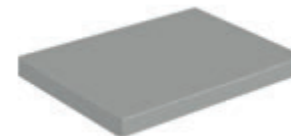

argilla (opz.9690)
clay (opt.9690)

mensole in alkorcell colore come ante alkorcell shelves same colour as doors

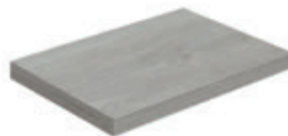

colori come ante (vedi pag.12)
colours same as doors (see page 12)

mensole in PET colore come ante PET shelves same colour as doors

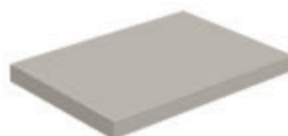

colori come ante (vedi pag.13)
colours same as doors (see page 13)

MODULARITÀ E COMPONENTIBILITÀ MODULARITY AND FITTING SOLUTIONS

BASI H 73
BASE UNITS H 73

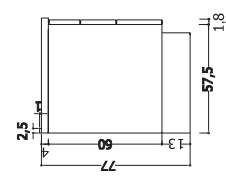

BASI SOSEPSE LIVING
HANGING LIVING BASE UNITS

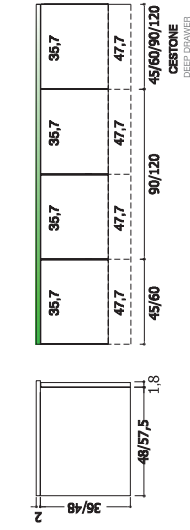

BASI LIVING CON ZOCCOLO
ROOM UNITS WITH PLINTH

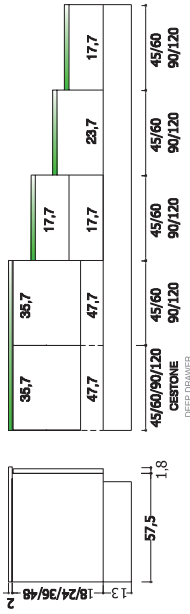

COLONNE FRIGO
FRIDGE COLUMNS

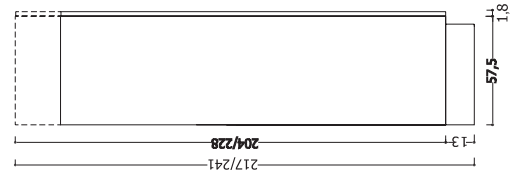

BASI LIVING CON PIEDINO CROMATO H 2
ROOM UNITS WITH FEET CHROME H 2

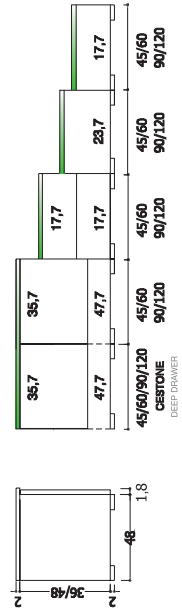

COLONNE FORNO
OVEN COLUMNS

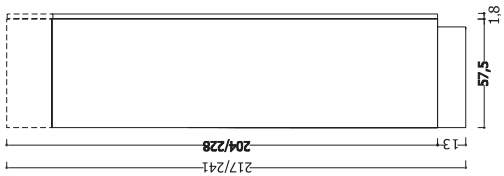

PENSILE CON APERTURA A RIBALTA

Le ante aprendosi verso l'alto consentono di avere un' ampia visione d'insieme all'interno del mobile. In questo modo è possibile un comodo accesso agli oggetti contenuti al suo interno e, dal punto di vista ergonomico, molto vantaggioso. La regolazione della forza di apertura può essere impostata in modo esatto in base al peso del frontale. Grazie all'arresto progressivo le ante si fermano in qualsiasi posizione; in questo modo la maniglia è sempre facilmente raggiungibile. La chiusura è ammortizzata di serie.

WALL UNIT WITH FLAP DOOR

The doors that open upwards guarantee ample overall visibility inside the cabinet. In this way, all objects housed inside the cabinet can be comfortably accessed, making the system highly advantageous from an ergonomic perspective. The opening force can be adjusted precisely according to the weight of the front. The doors stop in any position thanks to the gradual stopping movement; in this way, the handle is always easily accessible. The closing movement is cushioned standard.

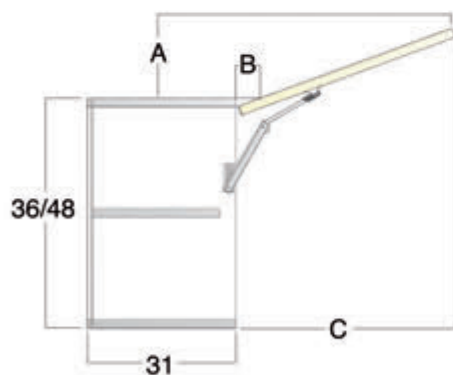

| | A | B | C |
|------|----|---|----|
| H 36 | 7 | 4 | 37 |
| H 48 | 11 | 4 | 49 |

APERTURA VERTICALE OBLIQUA

I pensili con questo tipo di meccanismo necessitano per l'apertura di poco spazio libero sopra il mobile grazie al movimento basculante dell'anta che si apre senza difficoltà applicando poca forza anche in presenza di frontali pesanti. Con l'arresto progressivo le ante si fermano in qualsiasi posizione; in questo modo la maniglia è sempre facilmente raggiungibile. La chiusura è ammortizzata ed è possibile regolare la forza di tenuta in base al peso del frontale.

VERTICAL OPENING OBLIQUE

Wall units that mount this type of mechanism require little clearance above the cabinet thanks to the swivelling movement of the door that can be easily opened by applying slight pressure, even with heavy fronts. The doors stop in any position thanks to the gradual stopping movement; in this way, the handle is always easily accessible. The closing movement is cushioned and the closing force can be adjusted according to the weight of the front door.

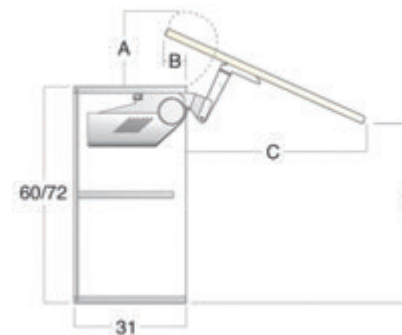

| | A | B | C | D |
|------|----|-----|------|------|
| H 60 | 18 | 9,6 | 46,5 | 53,5 |
| H 72 | 18 | 9,6 | 57 | 61 |

PENSILE CON APERTURA ANTE A PACCHETTO

Il meccanismo d'apertura ante a pacchetto è idoneo sia sul pensile H 72 che H 96; la regolazione della forza di apertura può essere impostata in modo esatto in base ai pesi dei frontali, la chiusura è ammortizzata e la cerniera centrale clip si contraddistingue per l'innovativa tecnologia che garantisce la sicurezza per le dita.

WALL UNIT WITH LIFT-UP FOLDING DOORS

The lift-up folding door opening mechanism is suitable for wall units with H 72 or H 96; the opening force can be adjusted precisely according to the weight of the fronts, while the closing movement is cushioned and the central clip-on hinge features innovative technology for safeguarding the fingers.

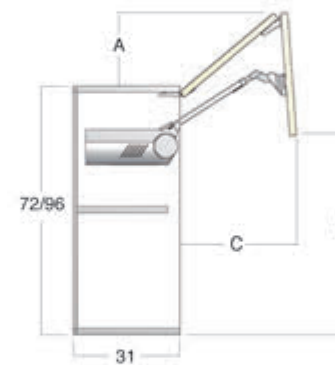

| | A | B | C |
|------|------|----|----|
| H 72 | 16,5 | 54 | 41 |
| H 96 | 20 | 69 | 53 |

SCHEMA MONTAGGIO LIMITATORE
LIMITER INSTALLATION
DIAGRAM

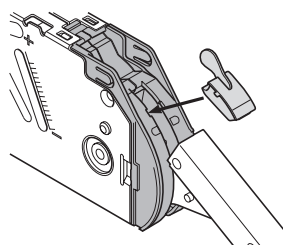















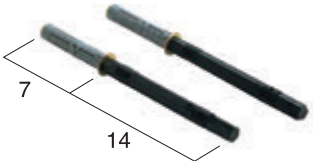

Per evitare l'interferenza dell'anta in fase di apertura con cornici o mensole, si può richiedere il limitatore dell'angolo di apertura cod. 5620005

In order to avoid that the door interferes with cornices or shelves during the opening movement, it is possible to request an opening angle limiter: code 5620005

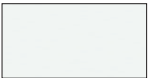
MENSOLE

SHELVES

| | COD. | | | COD. | | |
|--|------|--|--|------|--|--|
| <p>mensola sp. 3,8 in nobilitato colori come strutture L max cm 400 laminate shelf th. 3.8 carcasses colours max. length 400 cm</p>  <div style="display: flex; justify-content: space-around; margin-top: 10px;"> <div style="text-align: center;">  bianco (opz.001) white </div> <div style="text-align: center;">  conchiglia (opz.8910) shell </div> </div> <div style="display: flex; justify-content: space-around; margin-top: 10px;"> <div style="text-align: center;">  fango (opz.8860) mud </div> <div style="text-align: center;">  lavagna (opz.9620) slate grey </div> </div> <div style="display: flex; justify-content: space-around; margin-top: 10px;"> <div style="text-align: center;">  visone (opz.948M) mink </div> <div style="text-align: center;">  argilla (opz.9690) clay </div> </div> | | | | | | |
| | | | | | | |
| | | | | | | |
| <p>reggimensola a scomparsa fully integrated shelf bracket</p>  | | | | | | |
| | | | | | | |
| | | | | | | |
| <p>mensola sp. 3,8 in alkorcell come anta L max cm 270 alkorcell shelf th. 3.8 same as door max. length 270 cm</p>  <div style="display: flex; justify-content: space-around; margin-top: 10px;"> <div style="text-align: center;">  frassino bianco alpino (opz.2310) alpine-white ash </div> <div style="text-align: center;">  rovere greige (opz.2320) greige oak </div> <div style="text-align: center;">  betulla (opz.2311) birch </div> </div> | | | | | | |
| | | | | | | |
| | | | | | | |
| <p>mensola sp. 3,8 in PET come anta L max cm 270 PET shelf th. 3.8 same as door max. length 270 cm</p>  <div style="display: flex; justify-content: space-around; margin-top: 10px;"> <div style="text-align: center;">  gesso supermatt (opz.7464) super-matt gypsum </div> <div style="text-align: center;">  sahara supermatt (opz.7717) super-matt sahara </div> <div style="text-align: center;">  luna supermatt (opz.9610) super-matt moon </div> </div> <div style="margin-top: 10px;"> <div style="text-align: center;">  carbone supermatt (opz.9613) super-matt carbon </div> </div> | | | | | | |
| | | | | | | |
| | | | | | | |
| | | | | | | |
| | | | | | | |

LIVING

Spazi coordinati per avere un solo ambiente per cucinare, ricevere gli amici, pranzare e rilassarsi è una soluzione al desiderio di vivere la casa più liberamente, secondo stili di vita contemporanei, integrando cucina e living all'insegna di un nuovo linguaggio progettuale.

Coordinated spaces that create a single environment in which to cook, receive friends and relax is a solution that allows you to experience the home more freely.

In line with contemporary lifestyles, this solution integrates the kitchen and living area to create a new design language



LIVING KSM1



ANTE
doors

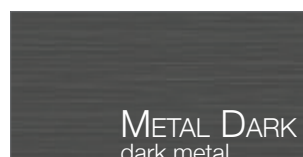
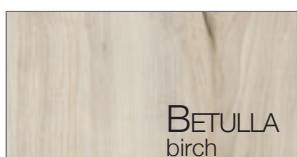

ELEMENTI A GIORNO
open units



STRUTTURE
carcasses

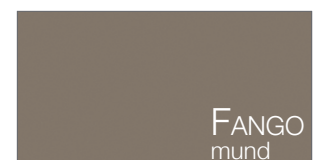

LIVING KSM1

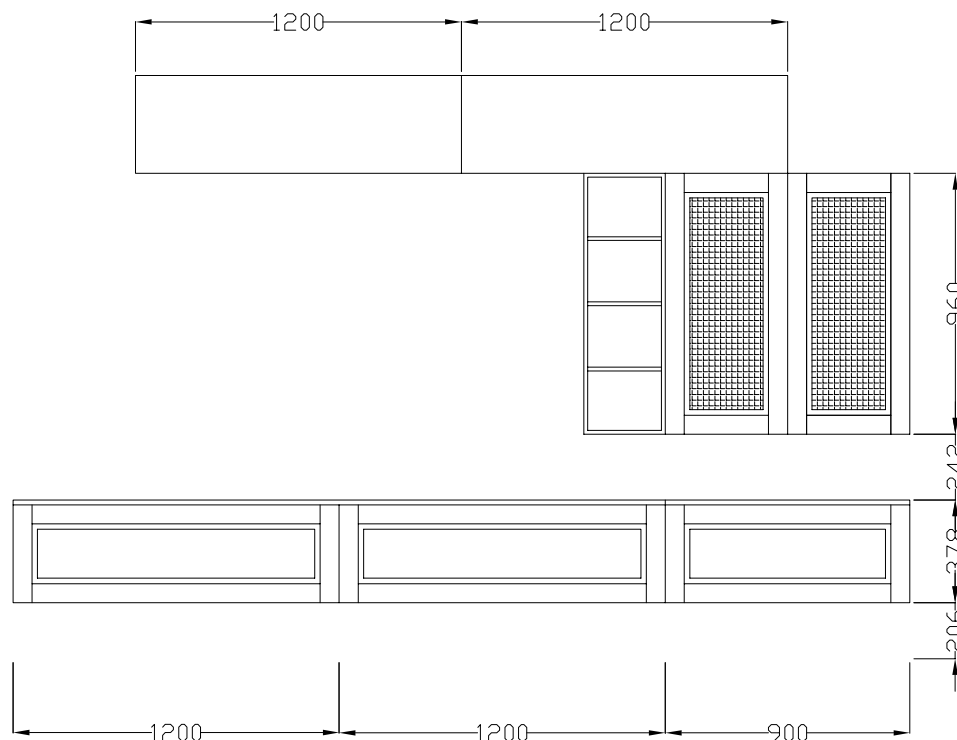

| NR. ELEMENTI | DESCRIZIONE | CODICE |
|--------------|---|----------------|
| 2 | Pensile L 120 H 36 P 33,1 ribalta tip-on, 1 fianco come anta | E210121T |
| 1 | Elemento a giorno L 30 H 96 P 31 laccato 4 vani | E7701735 |
| 2 | Pensile vetro L 45 H 96 P 33,1 apertura push-pull, ripiani vetro con luce | E1020450 |
| 4 | Profilo led GLASS_8 Italtal Pek per ripiano vetro L 45 | 08616263 |
| 1 | Trasformatore per luce GLASS_8 Italtal Pek 50W | 08616192A |
| 1 | Base living sospesa L 120 H 36 P 50,1 cestone apertura tip-on, 1 fianco come anta | EBL76200 |
| 1 | Base living sospesa L 120 H 36 P 50,1 cestone apertura tip-on | EBL76200 |
| 1 | Base living sospesa L 90 H 36 P 50,1 cestone apertura tip-on | EBL75900 |
| 1 | Top L 240+90 H 1,8 P 50,2 in alkorcell come anta | al ml TLM185A |
| 3 | Asta appendipensili ml 2 | al ml 08610501 |

| No. of ELEMENTS | DESCRIPTION | CODE |
|-----------------|--|-----------------|
| 2 | Wall unit W 120 H 36 D 33,1 flap door tip-on opening, 1 side same as door | E210121T |
| 1 | Lacquered open unit W 30 H 96 D 31 4 compartments | E7701735 |
| 2 | Glass wall unit W 45 H 96 D 33,1 push-pull opening, glass shelves with light | E1020450 |
| 4 | Led profile GLASS_8 Italtal Pek for glass shelf W 45 | 08616263 |
| 1 | Power supply for light GLASS_8 Italtal Pek 50W | 08616192A |
| 1 | Hanging living base unit W 120 H 36 D 50,1 deep drawer tip-on opening, 1 side same as door | EBL76200 |
| 1 | Hanging living base unit W 120 H 36 D 50,1 deep drawer tip-on opening | EBL76200 |
| 1 | Hanging living base unit W 90 H 36 D 50,1 deep drawer tip-on opening | EBL75900 |
| 1 | Alkorcell worktop W 240+90 H 1,8 D 50,2 same as door | per lm TLM185A |
| 3 | Wall unit fixing strip lm 2 | per lm 08610501 |

LIVING KSM2



ANTE
doors

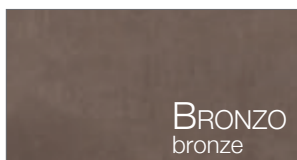

ELEMENTI A GIORNO
open units

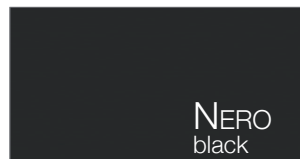

STRUTTURE
carcasses

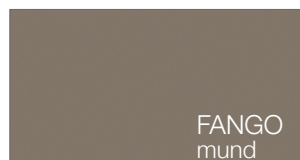

LIVING KSM2

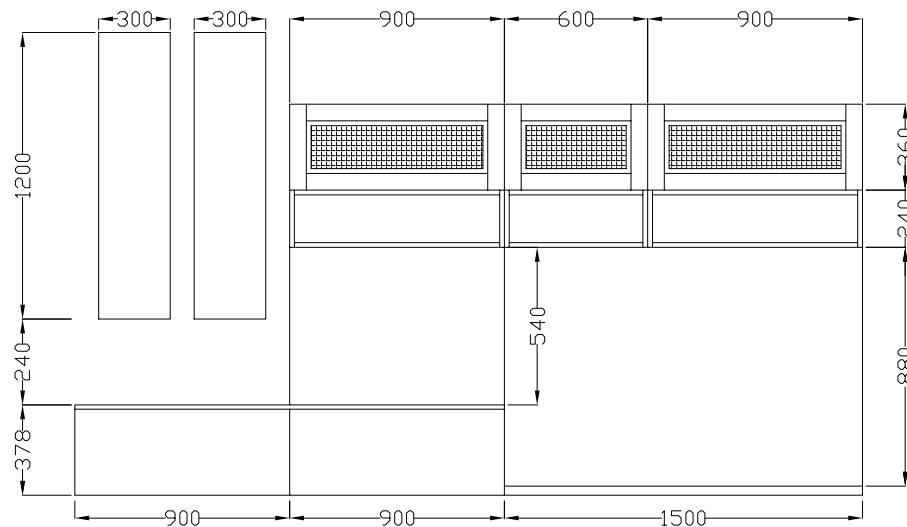

| NR. ELEMENTI | DESCRIZIONE | CODICE |
|--------------|---|----------------|
| 2 | Pensile L 30 H 120 P 33,1 apertura push-pull, fianchi come anta | E2145301/2 |
| 2 | Pensile vetro L 90 H 36 P 33,1 ribalta, 1 fianco come anta | E1100900 |
| 1 | Pensile vetro L 60 H 36 P 33,1 ribalta | E1100600 |
| 5 | Faretto Sunrise 58 L&S | 08618082 |
| 1 | Trasformatore Mec Drive 100-240V 36W L&S | 08618001 |
| 1 | Cavo di alimentazione Mec Drive L&S | 08618020 |
| 1 | Modulo Distributor 8 ways | 08618025 |
| 2 | Pensile a giorno alluminio AIR HI-LINE L 90 H 24 P 31 ripiano vetro | E7800090 |
| 1 | Pensile a giorno alluminio AIR HI-LINE L 60 H 24 P 31 ripiano vetro | E7800060 |
| 1 | Base living sospesa L 90 H 36 P 50 cestone apertura tip-on | EBL75900 |
| 1 | Base living sospesa L 90 H 36 P 50 cestone apertura tip-on,1 fianco come anta | EBL75900 |
| 1 | Mensola L 150 H 3,8 P 31 colore come anta | al ml 091523 |
| 1 | Top L 180 H 1,8 P 50,1 colore come anta | al ml TLE185 |
| 1 | Schienale L 150 H 88 sp.1,8 colore come anta | al mq 0943639 |
| 1 | Schienale L 90 H 54 sp.1,8 colore come anta | al mq 0943639 |
| 2 | Asta appendipensili ml 2 | al ml 08610501 |

| No. of ELEMENTS | DESCRIPTION | CODE |
|-----------------|--|-----------------|
| 2 | Wall unit W 30 H 120 D 33,1 push-pull opening, sides same as door | E2145301/2 |
| 2 | Glass wall unit W 90 H 36 D 33,1 flap door, 1 side same as door | E1100900 |
| 1 | Glass wall unit W 60 H 36 D 33,1 flap door | E1100600 |
| 5 | Sunrise 58 spotlight L&S | 08618082 |
| 1 | Mec Drive power supply 100-240V 36W L&S | 08618001 |
| 1 | Mec Drive power cable L&S | 08618020 |
| 1 | Distributor module 8 ways | 08618025 |
| 2 | Aluminium open wall unit AIR HI-LINE W 90 H 24 D 31 glass shelf | E7800090 |
| 1 | Aluminium open wall unit AIR HI-LINE W 60 H 24 D 31 glass shelf | E7800060 |
| 1 | Hanging living base unit W 90 H 36 D 50 deep drawer tip-on | EBL75900 |
| 1 | Hanging living base unit W 90 H 36 D 50 deep drawer tip-on 1 side same as door | EBL75900 |
| 1 | Shelf W 150 H 3,8 D 31 same colour as door | per lm 091523 |
| 1 | Worktop W 180 H 1,8 D 50,1 same colour as door | per lm TLE185 |
| 1 | Back panel W 150 H 88 th.1,8 same colour as door | per mq 0945639 |
| 1 | Back panel W 90 H 54 th.1,8 same colour as door | per mq 0945639 |
| 2 | Wall unit fixing strip lm 2 | per lm 08610501 |

LIVING KSM3



ANTA
door



FRASSINO
BIANCO ALPINO
alpine-white ash

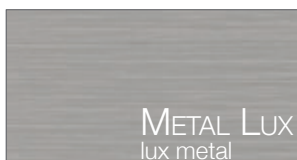

METAL LUX
lux metal

ELEMENTI A GIORNO
open units



NERO
black

STRUTTURA
carcass

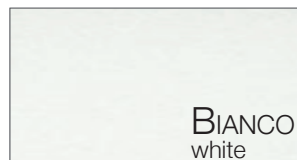

BIANCO
white



VISONE
mink

LIVING KSM3

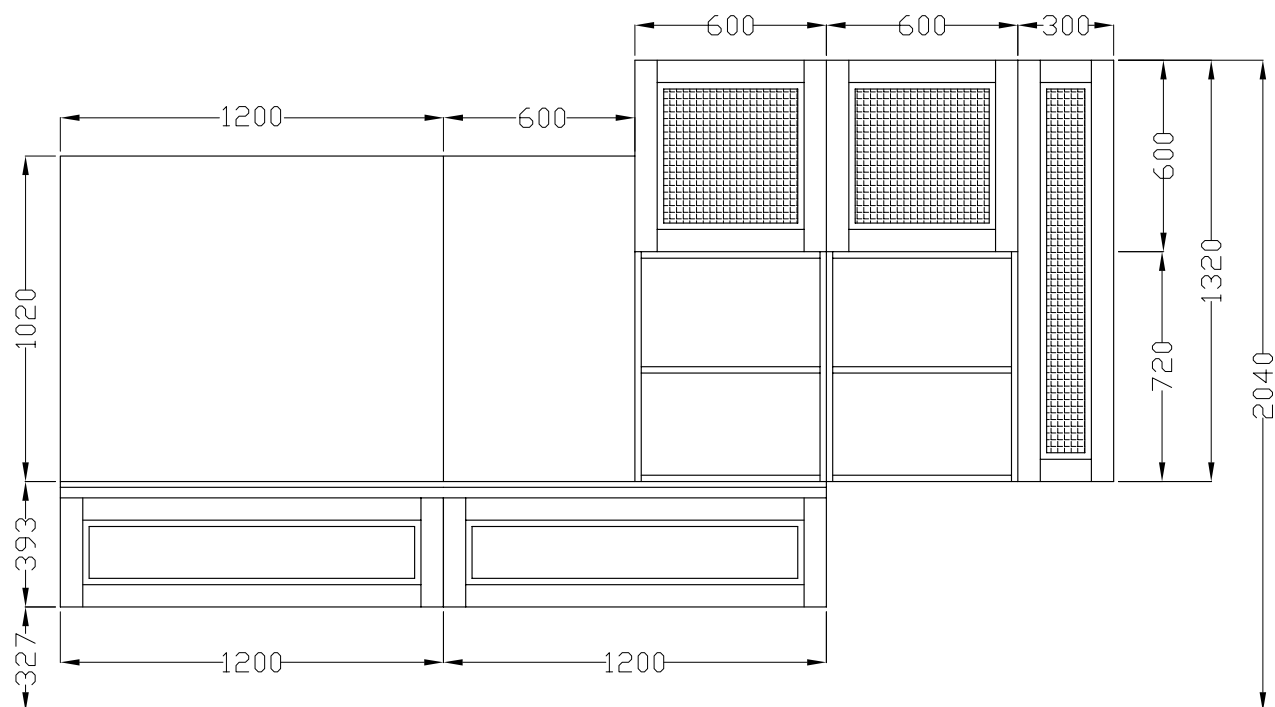

| NR. ELEMENTI | DESCRIZIONE | CODICE |
|--------------|---|----------------|
| 1 | Pensile vetro L 30 H 132 P 33,1 apertura push-pull, ripiani vetro | E1025301/2 |
| 2 | Pensile vetro L 60 H 60 P 33,1 apertura push-pull, ripiano vetro | E1060601/2 |
| 3 | Faretto Spot_3328 Ital Pek | 08616175 |
| 1 | Alimentatore 50W per faretto Spot_3328 Ital Pek | 08616192A |
| 2 | Pensile a giorno alluminio AIR HI-LINE L 60 H 72 P 31 ripiano vetro | E7804060 |
| 1 | Schienale L 120 H 102 sp.1,8 colore come anta | al mq 094571V |
| 1 | Schienale L 60 H 102 sp.1,8 colore come anta | al mq 094571V |
| 2 | Base living sospesa L 120 H 37,5 P 50,1, 1 fianco come anta | GBL76200 |
| 1 | Top L 240 H 1,8 P 50,2 colore come anta | al ml TLM185A |
| 1 | Asta appendipensili ml 2 | al ml 08610501 |

| No. of ELEMENTS | DESCRIPTION | CODE |
|-----------------|--|-----------------|
| 1 | Glass wall unit W 30 H 132 D 33,1 push-pull opening, glass shelves | E1025301/2 |
| 2 | Glass wall unit W 60 H 60 D 33,1 push-pull opening, glass shelf | E1060601/2 |
| 3 | Spot_3328 spotlight Ital Pek | 08616175 |
| 1 | Power supply 50W for Spot_3328 spotlight Ital Pek | 08616192A |
| 2 | Aluminium open wall unit AIR HI-LINE W 60 H 72 D 31 glass shelf | E7804060 |
| 1 | Back panel W 120 H 102 th.1,8 same colour as door | per mq 094571V |
| 1 | Back panel W 60 H 102 th.1,8 same colour as door | per mq 094571V |
| 2 | Hanging living base unit W 120 H 37,5 D 50,1, 1 side same as door | GBL76200 |
| 1 | Worktop W 240 H 1,8 D 50,2 same colour as door | per lm TLM185A |
| 1 | Wall unit fixing strip lm 2 | per lm 08610501 |

LIVING KSM4



ANTE
doors



ELEMENTI A GIORNO
open units



STRUTTURE
carcasses

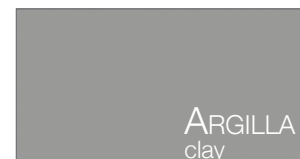

LIVING KSM4

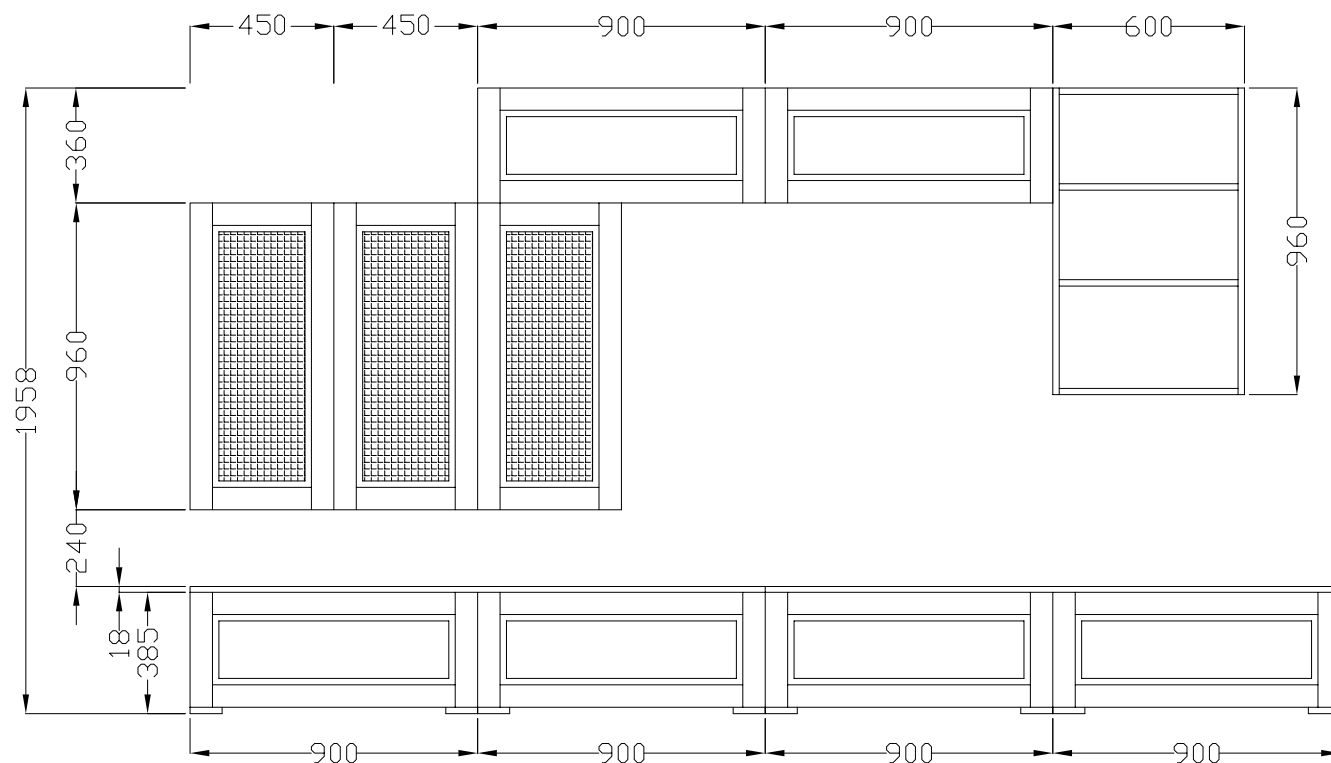

| NR. ELEMENTI | DESCRIZIONE | CODICE |
|--------------|---|----------------|
| 2 | Pensile L 90 H 36 P 33,1 anta ribalta tip-on, 1 fianco come anta | E210091T |
| 2 | Pensile vetro L 45 H 96 P 33,1 apertura push-pull, ripiani vetro con luce, 1 fianco come anta | E1020451/2 |
| 1 | Pensile vetro L 45 H 96 P 33,1 apertura push-pull, ripiani vetro con luce | E1020451/2 |
| 1 | Pensile a giorno alluminio AIR HI-LINE L 60 H 96 P 31 ripiani vetro | E7805060 |
| 2 | Base living L 90 H 36 P 50,1 cestone, 1 fianco come anta | EBL25900 |
| 2 | Base living L 90 H 36 P 50,1 cestone | EBL25900 |
| 1 | Top L 180+180 H 1,8 P 50,2 colore come anta | al ml TLM185A |
| 6 | Profilo led GLASS_8 Itai Pek per ripiano vetro L 45 | 08616263 |
| 1 | Trasformatore per luce GLASS_8 Itai Pek 50W | 08616192A |
| 2 | Asta appendipensili ml 2 | al ml 08610501 |

| No. of ELEMENTS | DESCRIPTION | CODE |
|-----------------|---|-----------------|
| 2 | Wall unit W 90 H 36 D 33,1 flap door tip-on, 1 side same as door | E210091T |
| 2 | Glass wall unit W 45 H 96 D 33,1 push-pull opening, glass shelves with light, 1 side same as door | E1020451/2 |
| 1 | Glass wall unit W 45 H 96 D 33,1 push-pull opening, glass shelves with light | E1020451/2 |
| 1 | Aluminium open wall unit AIR HI-LINE W 60 H 96 D 31 glass shelves | E7805060 |
| 2 | Living base unit W 90 H 36 D 50,1 deep drawer, side same as door | EBL25900 |
| 2 | Living base unit W 90 H 36 D 50,1 deep drawer | EBL25900 |
| 1 | Worktop W 180+180 H 1,8 D 50,2 same colour as door | per lm TLM185A |
| 6 | Led profile GLASS_8 Itai Pek for glass shelf W 45 | 08616263 |
| 1 | Power supply for light GLASS_8 Itai Pek 50W | 08616192A |
| 2 | Wall unit fixing strip lm 2 | per lm 08610501 |

COMPOSIZIONE BASSA L 255 (con gola L 260)

LOW COMPOSITION W 255 (with finger rail W 260)



COMPOSIZIONE BASSA L 300 (con gola L 305)

LOW COMPOSITION W 300 (with finger rail W 305)



COMPOSIZIONE BASSA L 255 (con gola L 260)

LOW COMPOSITION W 255 (with finger rail W 260)

COMPONENTI COMPONENTS

Colonna 60 frigo-freezer 230 classe A+

60 cm column fridge-freezer 230 class "A+"

Base 45 2 cassetti e cestone

45 cm base unit with 2 drawers and deep drawer

Base 60 forno statico inox con ventilazione tangenziale di raffreddamento

stainless steel static oven with orbital cooling ventilation 60 base unit

Piano cottura 60 4 gas inox con valvola di sicurezza

60 cm stainless steel hob with 4 gas burners with safety valve

Sottolavello 90

90 cm sink unit

Lavello ad incasso 86x50 1 vasca inox prelucidato

86x50 cm built-in sink with 1 stainless steel bowl

Pensile 45 H 72

45 cm wall unit H 72

Cappa 60 aspirante estraibile H 63 2 motori

60 cm hood slide-out ducting H 63 2 motors

Scolapiatti 90 H 72

90 cm plate rack H 72

Top 195 P 61 in laminato H 4

195 cm laminate worktop D 61 H 4

Asta appendipensili ml 2

2 lm wall unit fixing strip

(Elettrodomestici Indesit)
(Indesit appliances)

VERSIONI VERSIONS

ALKORCELL

BRIDGE

NECK

PET

BRIDGE

NECK

COMPOSIZIONE BASSA L 300 (con gola L 305)

LOW COMPOSITION W 300 (with finger rail W 305)

COMPONENTI COMPONENTS

Colonna 60 frigo-freezer 230 classe A+

60 cm column fridge-freezer 230 class "A+"

Base 60 2 cassetti e cestone

60 cm base unit with 2 drawers and deep drawer

Base 60 forno statico inox con ventilazione tangenziale di raffreddamento

stainless steel static oven with orbital cooling ventilation 60 base unit

Piano cottura 60 4 gas inox con valvola di sicurezza

60 cm stainless steel hob with 4 gas burners with safety valve

Base 60

60 cm base unit

Sottolavello 60

60 cm sink unit

Lavello ad incasso 86x50 1 vasca inox prelucidato

86x50 cm built-in sink with 1 stainless steel bowl

Pensile 60 H 72

60 cm wall unit H 72

Cappa 60 aspirante estraibile H 63 2 motori

60 cm hood slide-out ducting H 63 2 motors

Pensile 60 H 72

60 cm wall unit H 72

Scolapiatti 60 H 72

60 cm plate rack H 72

Top 240 P 61 in laminato H 4

240 cm laminate worktop D 61 H 4

Asta appendipensili ml 4

4 lm wall unit fixing strip

(Elettrodomestici Indesit)
(Indesit appliances)

VERSIONI VERSIONS

ALKORCELL

BRIDGE

NECK

PET

BRIDGE

NECK

COMPOSIZIONE ALTA L 300 (con gola L 305)

HIGH COMPOSITION W 300 (with finger rail W 305)



COMPOSIZIONE BASSA L 360 (con gola L 365)

LOW COMPOSITION W 360 (with finger rail W 365)



COMPOSIZIONE ALTA L 300 (con gola L 305)

HIGH COMPOSITION W 300 (with finger rail W 305)

COMPONENTI COMPONENTS

Colonna 60 frigo-freezer 230 classe A+

60 cm column fridge-freezer 230 class "A+"

Base 60 2 cassetti e cestone

60 cm base unit with 2 drawers and deep drawer

Base 60 forno statico inox con ventilazione tangenziale di raffreddamento

stainless steel static oven with orbital cooling ventilation 60 base unit

Piano cottura 60 4 gas inox con valvola di sicurezza

60 cm stainless steel hob with 4 gas burners with safety valve

Base 60

60 cm base unit

Sottolavello 60

60 cm sink unit

Lavello ad incasso 86x50 1 vasca inox prelucidato

86x50 cm built-in sink with 1 stainless steel bowl

Pensile 60 H 72

60 cm wall unit H 72

Cappa 60 aspirante estraibile H 63 2 motori

60 cm hood slide-out ducting H 63 2 motors

Pensile 60 H 96

60 cm wall unit H 96

Scolapiatti 60 H 96

60 cm plate rack H 96

Top 240 P 61 in laminato H 4

240 cm laminate worktop D 61 H 4

Mensola 120 P 31 sp. 3,8

120 cm shelf D 31 sp. 3,8

Asta appendipensili ml 4

4 lm wall unit fixing strip

(Elettrodomestici Indesit)
(Indesit appliances)

VERSIONI VERSIONS

ALKORCELL

BRIDGE

NECK

PET

BRIDGE

NECK

COMPOSIZIONE BASSA L 360 (con gola L 365)

LOW COMPOSITION W 360 (with finger rail W 365)

COMPONENTI COMPONENTS

Colonna 60 frigo-freezer 230 classe A+

60 cm column fridge-freezer 230 class "A+"

Colonna 60 con cestone, forno statico inox con ventilazione tangenziale di raffreddamento

60 column with deep drawer configured for stainless steel static oven with orbital cooling ventilation

Base 90 2 cassetti + cestone predisposto P.C.

90 cm base unit with 2 drawers + deep drawer configured for hob

Piano cottura 60 4 gas inox con valvola di sicurezza

60 cm stainless steel hob with 4 gas burners with safety valve

Base 60

60 cm base unit

Sottolavello 90

90 cm sink unit

Lavello ad incasso 86x50 1 vasca inox prelucidato

86x50 cm built-in sink with 1 stainless steel bowl

Pensile 60 H 72

60 cm wall unit H 72

Cappa 90 sempione acciaio inox satinato + vetro

90 cm sempione hood brushed stainless steel + glass

Pensile 60 H 72

60 cm wall unit H 72

Scolapiatti 90 H 72

90 cm plate rack H 72

Top 240 P 61 in laminato H 4

240 cm laminate worktop D 61 H 4

Top 60 P 61 in laminato H 4

60 cm laminate worktop D 61 H 4

Asta appendipensili ml 4

4 lm wall unit fixing strip

(Elettrodomestici Indesit)
(Indesit appliances)

VERSIONI VERSIONS

ALKORCELL

BRIDGE

NECK

PET

BRIDGE

NECK