

EDEN

Master Bathroom Collection

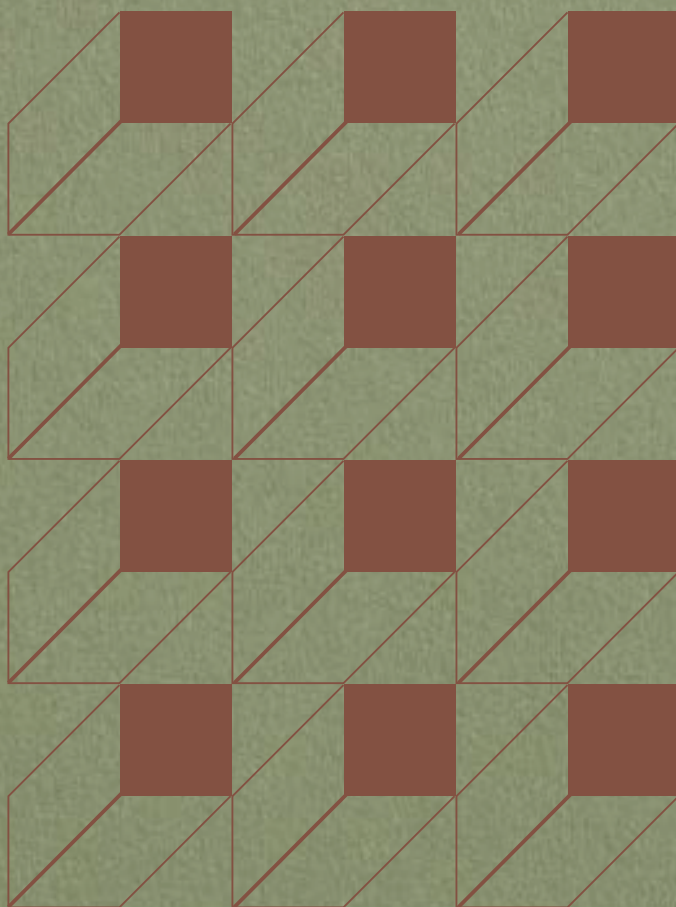



OASIS is an Italian entrepreneurial family story that starts in 1908 from a small workshop. Today we are an industrial company with a global exposure but deep roots in the Italian high-end furniture tradition. The goal of our fourth generation is to bring traditional Italian design and quality to a refined cosmopolitan consumer who is looking for a tailor-made service.

OASIS è una storia familiare imprenditoriale italiana che inizia nel 1908 da un laboratorio di falegnameria. Oggi siamo un'azienda industriale con un'esposizione globale, ma con radici profonde nella tradizione italiana dell'arredamento di alta gamma. L'obiettivo della quarta generazione è portare il design e la qualità della tradizione italiana a un consumatore raffinato e cosmopolita che cerca un servizio su misura.

Timeless elegance, craftsmanship
and quality. These are the distinctive
features of our products.

Eleganza senza tempo, artigianalità e qualità.
Queste sono le caratteristiche distintive dei nostri prodotti.





Eden Collection

Eden is the most recent addition to the Oasis Master Bathroom Collection.

The collection comes in a wide variety of finishes. From glossy, matt or metallic lacquers to porcelain stone and a multitude of real wood veneers. It is also available in coloured glass or ribbed coloured glass with integrated washbasins of various shapes and materials: Purefeel, Geacril, Corian, marble, porcelain stone and glass.

The Collection is modular in design, thereby ensuring an optimal use of space within the bathroom. In addition to vanities, there are tall units, wall units, open shelves and mirrors, all designed to form a coherent and sophisticated ambience.

EDEN è l'ultima novità della Master Collection di Oasis. Dal design pulito e moderno, Eden è disponibile in una grande varietà di finiture: da quelle laccate, opache e metalliche; al Gres, legno impiallacciato e vetro colorato liscio o cannettato. I lavabi integrati sono di varie forme e materiali: Purefeel, Geacril, Corian, marmo, Gres porcellanato e vetro. La collezione è realizzata in dimensioni che garantiscono un uso ottimale dello spazio all'interno del bagno. Oltre ai mobili lavabo, la gamma completa comprende pensili, colonne, boiserie e specchi pensati per creare un ambiente coerente e sofisticato.

EDEN_001

ALASKA WHITE - EUCALYPTUS

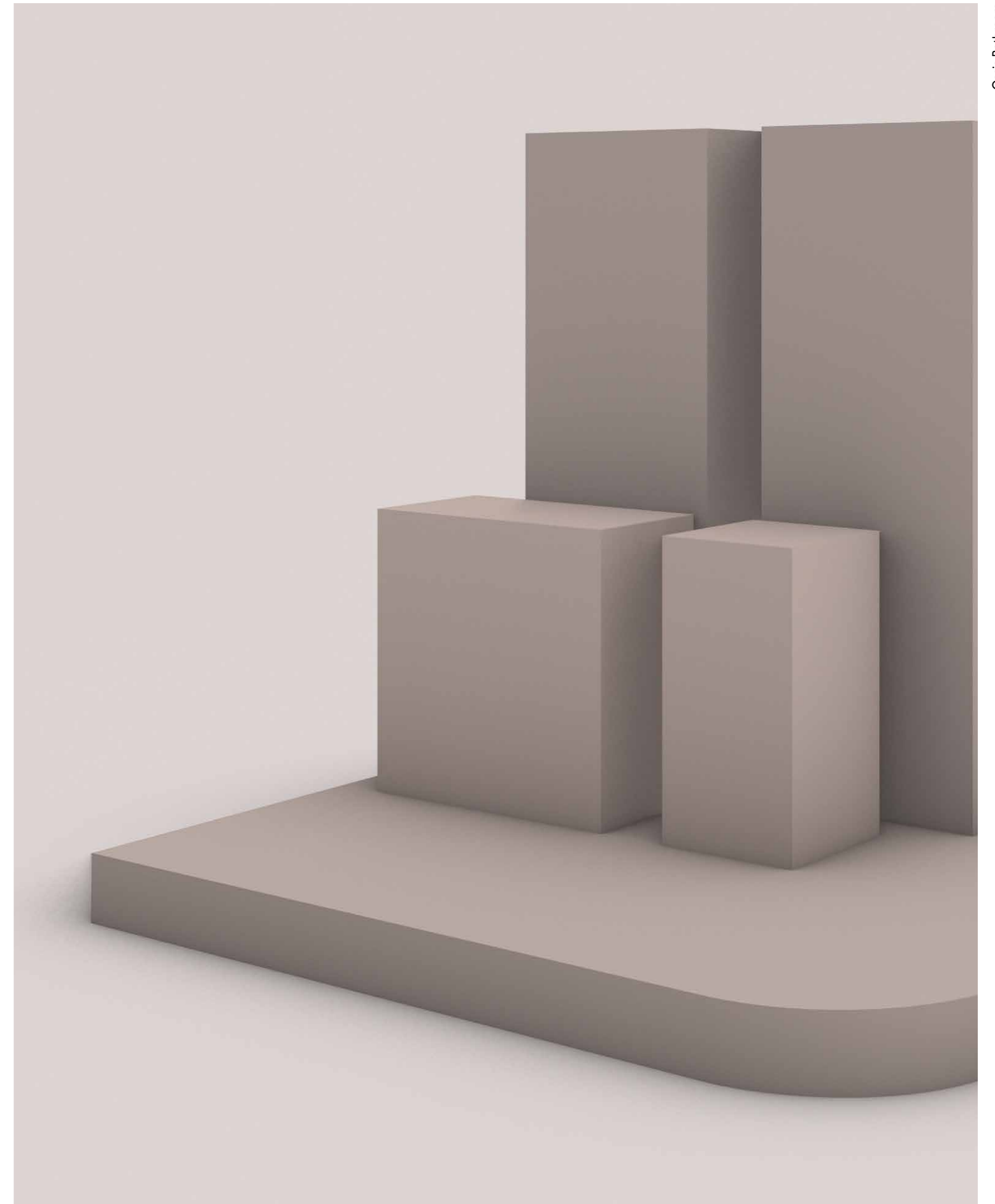







Composition made of two vanity units and the top in porcelain stone 12 cm with integrated washbasin, also available with the additional base without the integrated washbasin. The two modules with different widths create movement and dynamism within the space.

This effect is given also by the modules with stopsol glass doors and the LINE light bar. In front of SIDNEY sanitary ware there are CUBE tall units that are 80 cm high in Eucalyptus finish. These one are hidden in the room thanks to the boiserie in the same finish.

The light that derives from the window highlights the finishes and also the presence of the SIRIO bathtub in matt white Lightfeel finish.

Composizione composta da due mobili portalavabo a terra e top in gres 12 cm con vasca integrata, disponibile anche nella versione complementare privo di vasca integrata. I due moduli dalle larghezze differenti creano un contesto di movimento e dinamicità all'interno dell'ambiente, suggerito anche dal ritmo di pieni e vuoti creati dai moduli aperti e con ante a vetro stopsol della barra luminosa LINE.

Posizionate in corrispondenza dei sanitari SIDNEY sono le colonne CUBE con altezza 80 cm in finitura Eucalyptus, inglobate e nascoste nell'ambiente grazie a boiserie in medesima finitura. La finestra perpendicolare alla composizione permette alla luce di evidenziarne le finiture materiche e risalta inoltre la presenza della vasca SIRIO in finitura Lightfeel bianco opaco.

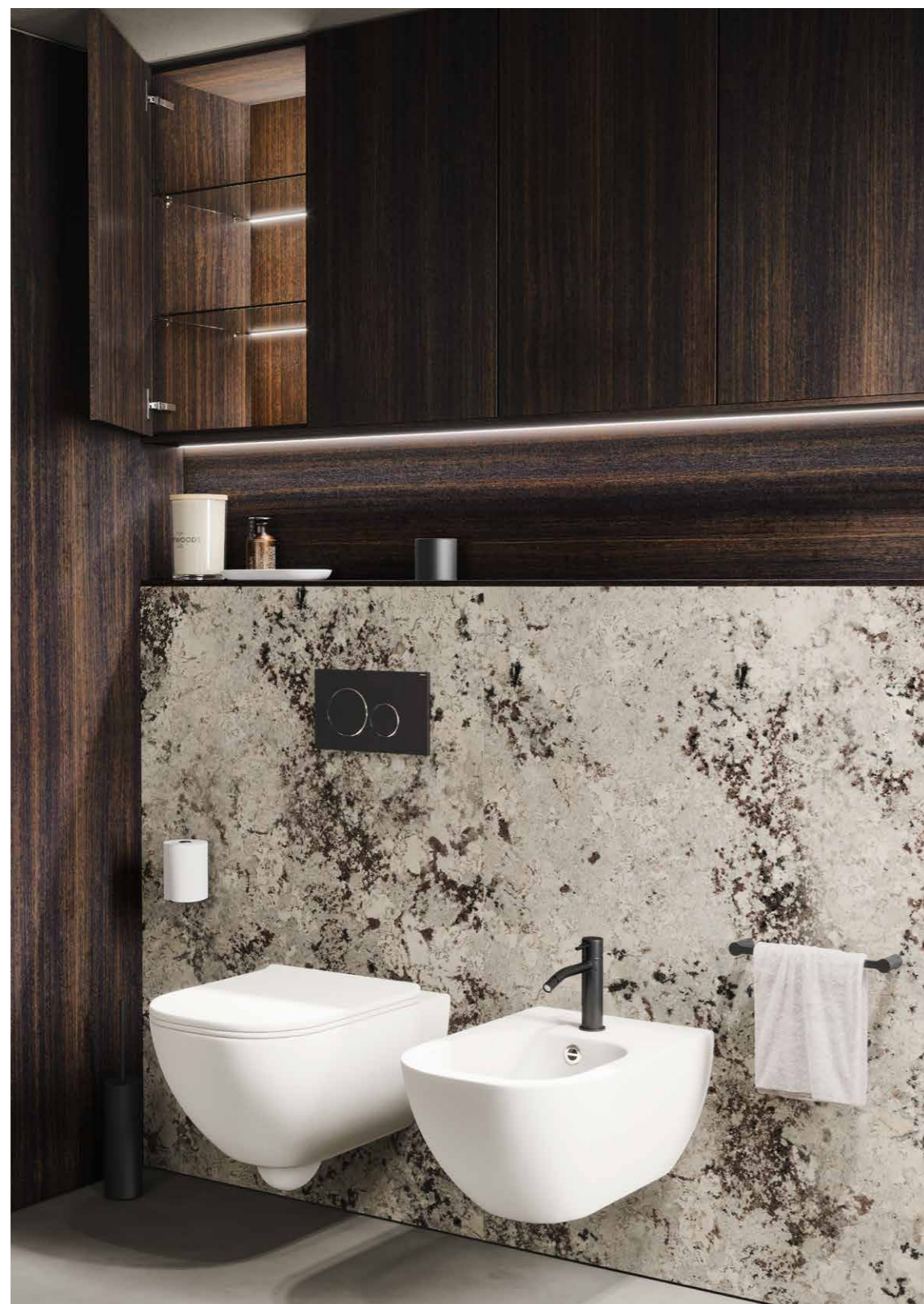

**Composition ED_001**

Structure:
 W 1,2 + 60 + 1,2 cm | 1,2 + 120 + 1,2 cm
 D 52,5 cm
 H 3 + 73 + 12 cm | 3 + 73 + 12 cm
 Eucalyptus finish

Band below the basin:
 Lacquered "Nero Lavagna" finish

Top:
 "Alaska White" porcelain stone with
 Rock integrated washbasin

Dali Full Mirror:
 L 63 cm - H 180 cm

**Deck mounted single lever basin Stilo
 mixer:**
 Brushed black

Lume lamp:
 Black

Line bar and modules:
 Brushed black Aluminium with stopsol
 glass doors

Sirio bathtub:
 Matt white Lightfeel

Freestanding bath Stilo mixer:
 Brushed black

Sidney wall-hung sanitary ware:
 Matt white ceramic

Deck mounted Stilo bidet mixer:
 Brushed black

Cube tall units:
 Eucalyptus finish
 L 45 cm - H 80 cm

Defilè accessories:
 Black finish

Composizione ED_001

Struttura:
 W 1,2 + 60 + 1,2 cm | 1,2 + 120 + 1,2 cm
 D 52,5 cm
 H 3 + 73 + 12 cm | 3 + 73 + 12 cm
 Eucalyptus

Fascia sottolavabo:
 Laccato "Nero Lavagna"

Top:
 Gres "Alaska White" con vasca integrata
 Rock

Specchio Dali Full:
 L 63 cm - H 180 cm

Miscelatore lavabo Stilo:
 Nero spazzolato

Lampada Lume:
 Nero

Barra e moduli Line:
 Alluminio nero spazzolato con ante in
 vetro stopsol
 W 30 + 60 + 30 + 30 cm

Vasca Sirio:
 Lightfeel bianco opaco

Colonna miscelatore vasca da terra Stilo:
 Nero spazzolato

Sanitari Sidney sospesi:
 Ceramica bianca opaca

Miscelatore per bidet Stilo:
 Nero spazzolato

Colonne Cube:
 Eucalyptus
 L 45 cm - H 80 cm

Accessori Defilè:
 Nero opaco

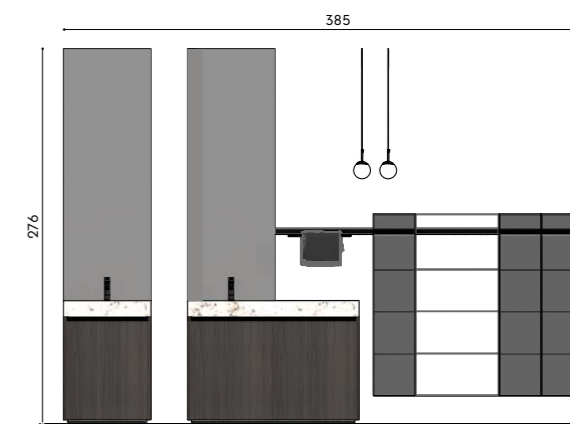

EDEN_002

HEAT TREATED OAK - BIANCO GHIACCIO

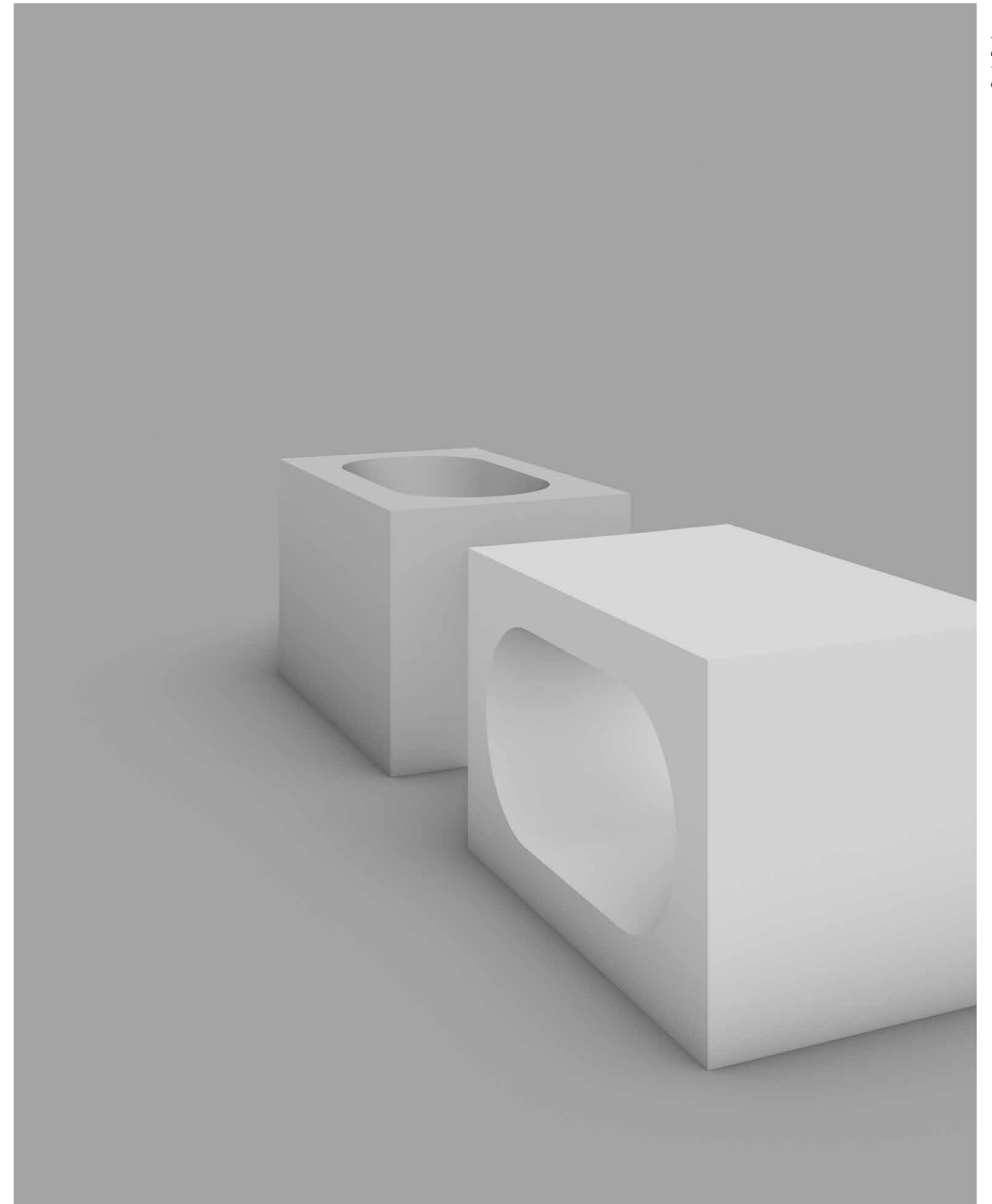





Composition made of two vanity units and an additional base with a height of 51 cm. The drawers are in Glossy White Ice lacquered ribbed glass finish while the illumination is given by ACCA mirror with LED integrated lighting and a switch. Complements like OTTO poufs match with the composition.

The composition is available with a matt black glass structure with ROSE integrated washbasin and frontal drawers in Heat Treated Oak finish.

Composizione composta da due mobili portalavabo e da un mobile complementare ad altezza 51 cm, alleggerita dalla finitura in vetro cannettato bianco ghiaccio lucido dei cassetti, mentre l'illuminazione è data dallo specchio ACCA con luce led integrata ed interruttore. I complementi utilizzati in abbinata alla composizione sono i pouf OTTO.

La composizione è inoltre disponibile nella variante con struttura in vetro nero satinato con top e vasca integrata ROSE e i frontali dei cassetti in finitura Heat Treated Oak.







Composition ED_002

Structure:
W 0,5 + 80 + 35 + 80 + 0,5 cm
D 52,5 cm
H 50 + 1,2 cm
Glossy White Ice lacquered ribbed
glass finish

Band below the basin:
"Nero Lavagna" lacquered finish

Top:
Matt white Corian with Harry
integrated washbasin

Wall mounted Stilo mixer with spout:
Brushed black

Acca mirror:
Heat Treated Oak panel
W 197 - D 15 - H 80 cm

_Complements
Otto pouf

_Variante

Structure:
Matt black glass

Frontal drawers:
Heat Treated Oak

Top:
Matt black glass with Rose integrated
washbasin

Composizione ED_002

Struttura:
W 0,5 + 80 + 35 + 80 + 0,5 cm
D 52,5 cm
H 50 + 1,2 cm
Vetro cannettato bianco ghiaccio lucido

Fascia sottolavabo:
Laccato "Nero lavagna"

Top:
Corian bianco opaco con vasca integrata
Harry

Miscelatore a parete con bocca di
erogazione Stilo:
Nero spazzolato

Specchio Acca:
Telaio in Heat Treated Oak
W 197 - D 15 - H 80 cm

_Complementi
Pouf Otto

_Variante

Struttura:
Vetro nero satinato

Frontali cassetti:
Heat Treated Oak

Top:
Vetro nero satinato con vasca integrata Rose

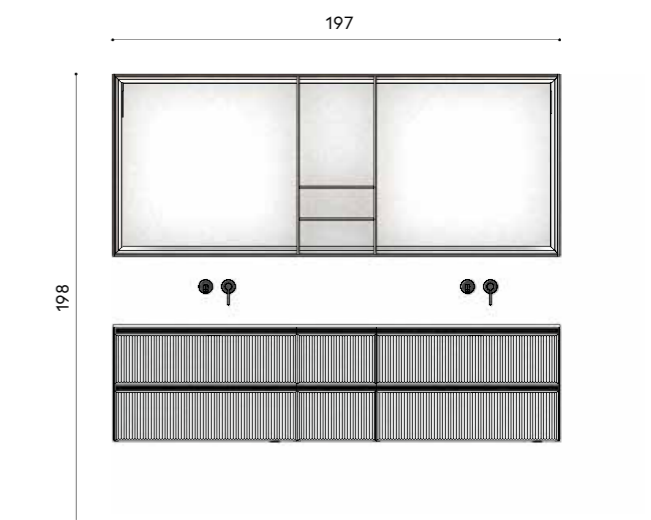

EDEN_003

PIETRA PIASENTINA GRIGIA - CHARCOAL OAK







Composition made of two vanity units H 31 cm in Pietra Piasentina porcelain stone finish. ROMA mirror in glass smoked finish is 90 cm high and 90 cm large. It is provided with LED lighting and a switch. VOLCANO countertop basin in Lightfeel is combined with the bathtub of the same collection and together they give a touch of freshness to the whole room. The composition combines with CUBE tall unit and MAX tall unit both with Charcoal Oak wood doors, ALU tall unit with smoked glass doors and the new RIGA boiserie in Pietra Piasentina porcelain stone.

Composizione composta da due mobili portalavabo alti 31 cm in finitura gres Pietra Piasentina. La luce e l'interruttore sono integrati nel nuovo specchio ROMA alto e largo 90 cm in finitura specchio fumè, mentre il lavabo in appoggio VOLCANO abbinato alla vasca della medesima collezione in Lightfeel bianco, dona un tocco di freschezza all'intero ambiente. In abbinata alla composizione sono le nuove colonne CUBE e MAX con ante in Charcoal Oak, le ante a vetro ALU e la nuova boiserie RIGA in finitura gres Pietra Piasentina.

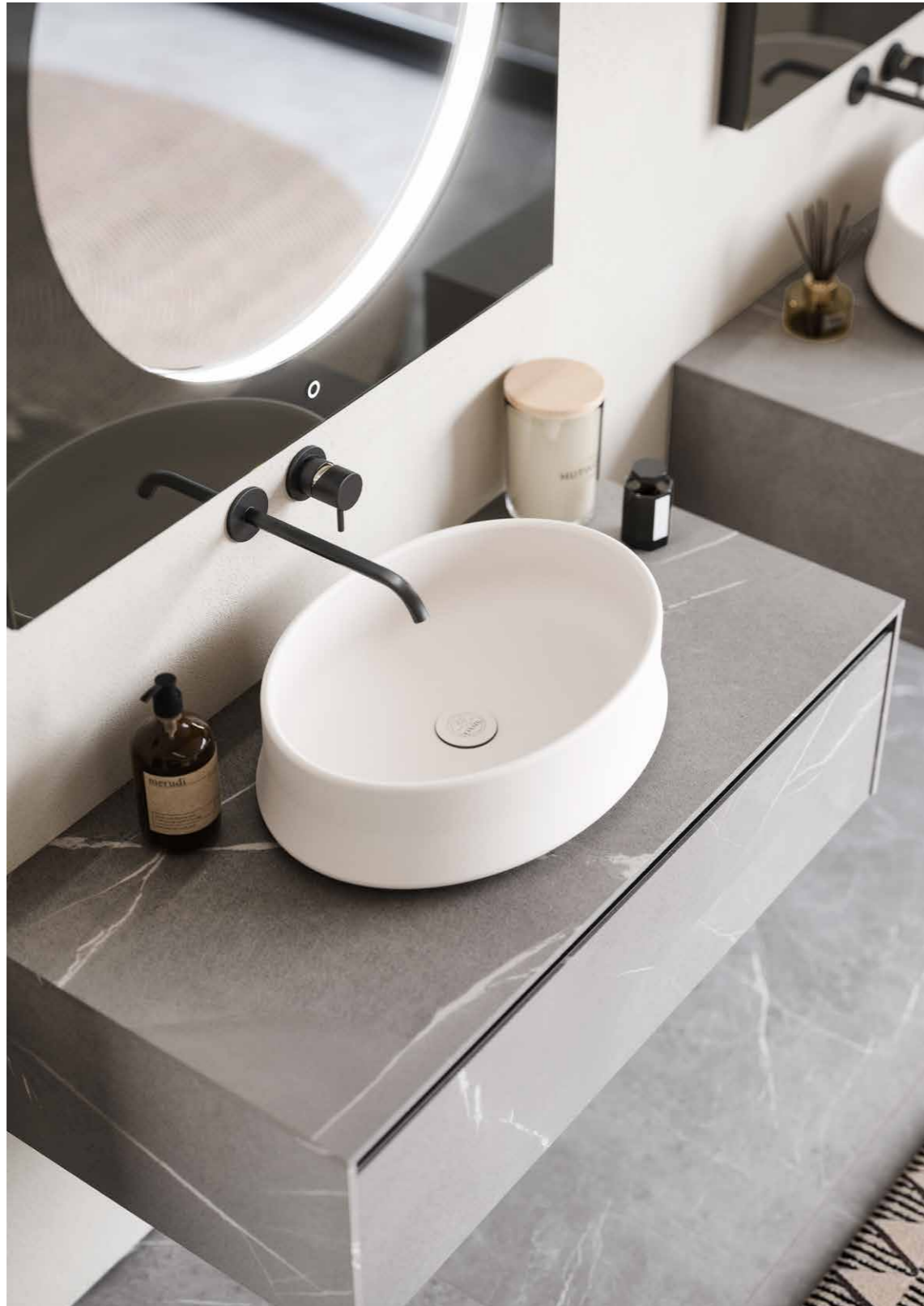

**Composition ED_003**

Structure:
 W 1,2 + 105 + 1,2 cm
 D 52,5 cm
 H 30 + 1,2 cm
 Pietra Piasentina porcelain stone finish

Band below the basin:
 "Nero Lavagna" lacquered finish

Top:
 Piasentina porcelain stone

Volcano washbasin:
 White Lightfeel H 15 cm

Roma mirror:
 L 90 cm – H 90 cm

Deck mounted single lever basin Stilo mixer: Satin-brushed black

Cube tall units:
 Doors in Charcoal Oak wood H 196 cm

Max tall units:
 Doors in Charcoal Oak wood H 196 cm

Alu tall units with integrated LED lighting behind the shelves:
 Satin-brushed Black aluminium frame with smoked glass doors H 196 cm

Riga Boiserie:
 Panel in Pietra Piasentina porcelain stone, shelves in satin-brushed black aluminium H 196 cm

Volcano bathtub:
 White Lightfeel

Stilo freestanding bath mixer:
 Satin-brushed black

Composizione ED_003

Struttura:
 W 1,2 + 105 + 1,2 cm
 D 52,5 cm
 H 30 + 1,2 cm
 Gres Pietra Piasentina

Fascia sottolavabo:
 Laccato Nero lavagna

Top:
 Gres Pietra Piasentina

Lavabo Volcano:
 Lightfeel bianco
 H 15 cm

Specchio Roma:
 L 90 cm – H 90 cm

Miscelatore lavabo Stilo:
 Nero spazzolato

Colonne Cube:
 Ante in Charcoal Oak
 H 196 cm

Colonne Max:
 Ante in Charcoal Oak
 H 196 cm

Colonne Alu con luce led integrata dietro i ripiani:
 Telaio in alluminio nero spazzolato con vetro fumè H 196 cm

Boiserie Riga:
 Pannello in gres Pietra Piasentina, mensole in alluminio nero spazzolato H 196 cm

Vasca Volcano:
 Lightfeel bianco

Colonna miscelatore vasca da terra Stilo:
 Nero spazzolato

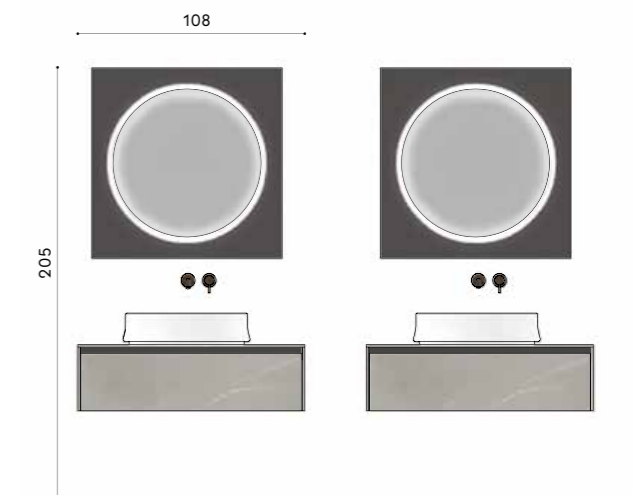

EDEN_004

NOIR DESIR - GIANDUIA

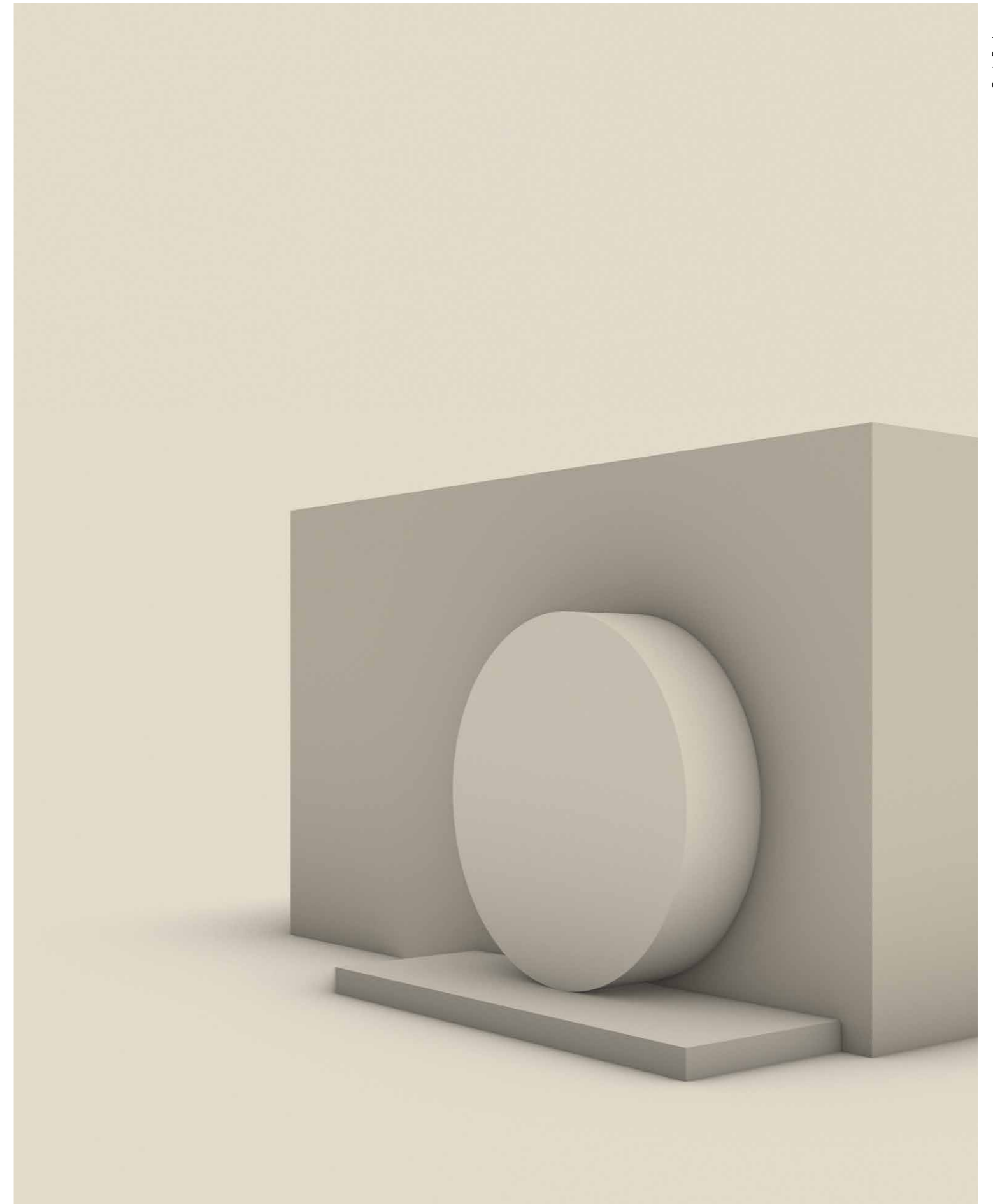





Composition created by a vanity unit, a base and an additional base with 2 drawers, a 1,2 cm thick top in Noir Desir porcelain stone with a vein passing through the edge, all in a height of 51 cm. The dynamism of the modular composition is suggested by the combination of the JOYCE round mirror and the TETRIS lamp positioned at the centre. In the background we find the RIGA boiserie which covers a portion of the wall and is combined with the SIRIO bathtub in matt white lightfeel with freestanding mixer in brushed steel. The large window creates a suggestive opening, while the boiserie in Noir Desir porcelain stone finish and KIM poufs give a refined and precious touch to the room. Also available in the variant with matt white purefeel top with CUT integrated washbasin and TETRIS DX version lamp, positioned on the right side of JOYCE mirror.

Composizione con un mobile portalavabo e due basi complementari, completata da un top in Gres Noir Desir con spessore 1,2 cm con vena passante anche nel bordo, il tutto in altezza 51 cm.

Il carattere vivace della composizione modulare è suggerito dall'abbinamento dello specchio tondo JOYCE e della lampada TETRIS posizionata centralmente. In secondo piano troviamo la boiserie RIGA che riveste in tutta altezza una porzione di parete e viene accostata alla vasca SIRIO in lightfeel bianco opaco con colonna miscelatore in acciaio spazzolato. La grande vetrata crea un'apertura suggestiva verso l'esterno, mentre le boiserie in finitura Gres Noir Desir regalano un tocco ricercato e prezioso all'ambiente anche grazie ai pouf KIM. Disponibile inoltre nella variante con top in purefeel bianco opaco con vasca integrata CUT e lampada versione TETRIS DX, posizionata in questo caso nel lato destro dello specchio JOYCE.



**Composition ED_004**

Structure:
 W 1,2 + 70 + 70 + 45 + 1,2 cm
 D 52,5 cm
 H 50 + 1,2 cm
 Gianduia Metallic lacquered finish

Band below the basin:
 Gianduia Metallic lacquered finish

Top:
 Noir Desir porcelain stone with
 Rock integrated washbasin

Joyce mirror:
 Ø120 cm

Tetris lamp:
 Black

**Deck mounted spout and deck
 mounted single lever basin mixer:**
 Brushed steel

Sirio bathtub:
 Lightfeel in matt white

Freestanding bath Stilo mixer:
 Brushed steel

Riga boiserie:
 Panel in Gianduia Metallic lacquered
 finish, shelves in Brushed black
 Aluminium

Defilé accessories:
 Black finish

_Complements
 Kim pouf

_Variant
Top:
 White purefeel with Cut integrated
 washbasin

Tetris dx Lamp:
 Black

Composizione ED_004

Struttura:
 W 1,2 + 70 + 70 + 45 + 1,2 cm
 D 52,5 cm
 H 50 + 1,2 cm
 Laccato metallizzato Gianduia

Fascia sottolavabo:
 Laccato metallizzato Gianduia

Top:
 Gres Noir Desir con vasca integrata
 Rock

Specchio Joyce:
 Ø120 cm

Lampada Tetris:
 Nero

**Bocca di erogazione e miscelatore
 monocomando Stilo:**
 Acciaio spazzolato

Vasca Sirio:
 Lightfeel bianco opaco

Colonna miscelatore vasca da terra Stilo:
 Acciaio spazzolato

Boiserie Riga:
 Pannelli in Gianduia Laccato
 metallizzato, mensole in alluminio nero
 spazzolato

Accessori Defilé:
 Nero opaco

_Complementi
 Pouf Kim

_Variante
Top:
 Purefeel bianco con vasca integrata Cut

Lampada Tetris dx:
 Nero

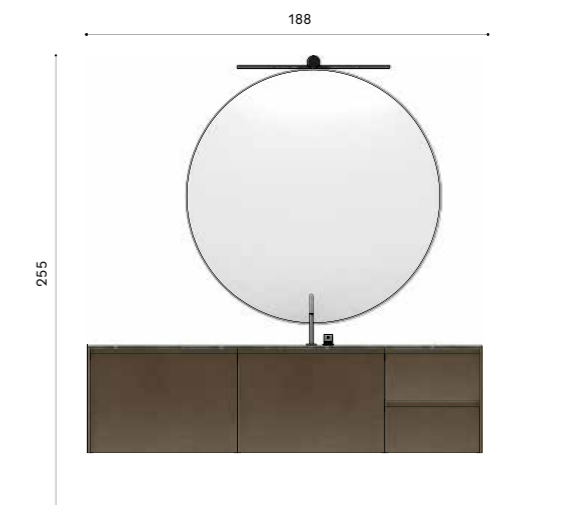

EDEN_005

TORTORA ELEGANCE - CHARCOAL OAK

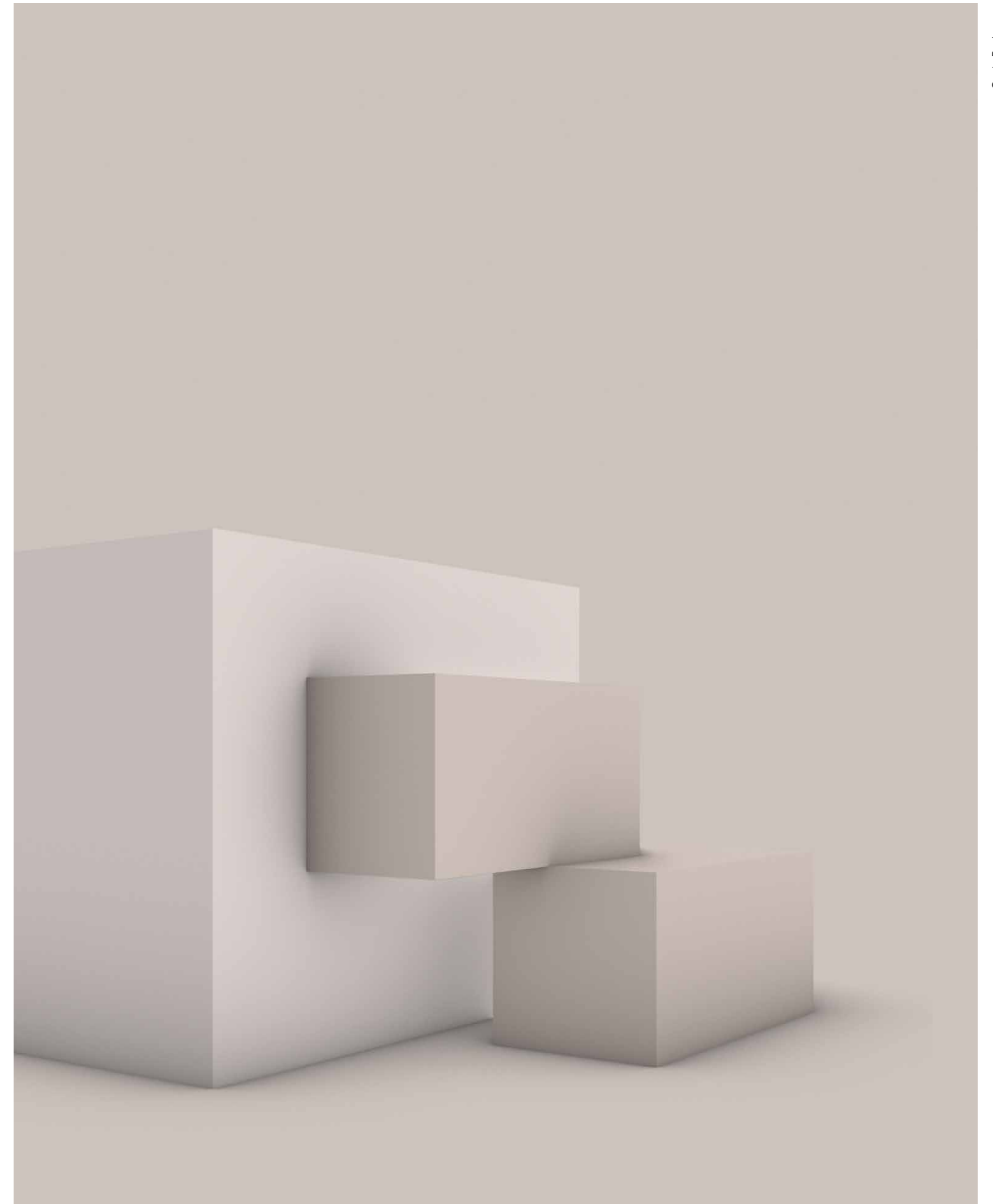





Composition made of a vanity unit, an additional wall-hung base H 51 cm with one drawer and a wall mounted base unit with open compartment provided with LED lighting. The top is in "Tortora elegance" Purefeel with Cut integrated washbasin. LUME lamp and My Sun mirror illuminate the whole arrangement. The room is enriched by HYDRA bathtub in matt white Lightfeel and a boiserie in Charcoal Oak wood.

Composizione composta da un mobile portalavabo e uno complementare di altezza 51 cm con cassetto e vano a giorno integrato completo di luce led. Il top è in finitura Purefeel colore Tortora elegance con vasca integrata CUT, mentre l'illuminazione è data non solo dalle lampade LUME, ma anche dallo specchio MY SUN. L'ambiente si completa con la vasca HYDRA in lightfeel bianco opaco e viene contornato da boiserie in finitura Charcoal Oak.



**Composition ED_005**

Structure:
 W 1,2 + 80 + 45 + 1,2 cm
 D 52,5 cm
 H 50 + 1,2 cm
 Matt "Tortora elegance"
 lacquered finish

Band below the basin:
 Matt "Tortora elegance"
 lacquered finish

Top:
 "Tortora elegance" Purefeel with
 Cut integrated washbasin

**Wall mounted base unit with open
 compartment provided with LED
 lighting:**
 Matt "Tortora elegance"
 lacquered finish

Lume lamp:
 Black

My Sun mirror:
 Frame in matt "Tortora elegance"
 lacquered finish
 L 120 cm – H 80 cm

Stilo mixer:
 Satin-brushed black

Hydra bathtub:
 Matt white Lightfeel

Stilo freestanding bath mixer:
 Satin-brushed black

Sidney Sanitary ware (wall-hung):
 Matt white ceramic

Deck mounted Stilo bidet mixer:
 Satin-brushed black

Defilè accessories:
 Black finish

Composizione ED_005

Struttura:
 W 1,2 + 80 + 45 + 1,2 cm
 D 52,5 cm
 H 50 + 1,2 cm
 Laccato Tortora elegance opaco

Fascia sottolavabo:
 Laccato Tortora elegance opaco

Top:
 Purefeel colore Tortora elegance con
 vasca integrata Cut

Vano a giorno con luce led integrata:
 Laccato Tortora Elegance opaco

Lampade Lume:
 Nero

Specchio My Sun:
 Telaio laccato Tortora Elegance opaco
 L 120 cm – H 80 cm

Miscelatore lavabo Stilo:
 Nero spazzolato

Vasca Hydra:
 Lightfeel bianco opaco

Colonna miscelatore vasca da terra Stilo:
 Nero spazzolato

Sanitari Sidney sospesi:
 Ceramica bianca opaca

Miscelatore per bidet Stilo:
 Nero spazzolato

Accessori Defilè:
 Nero opaco

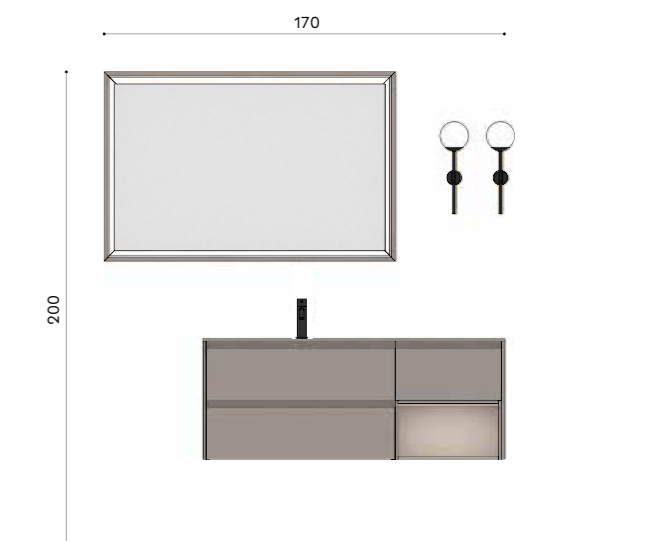

EDEN_006

GREY CHESTNUT - LIGHTFEEL

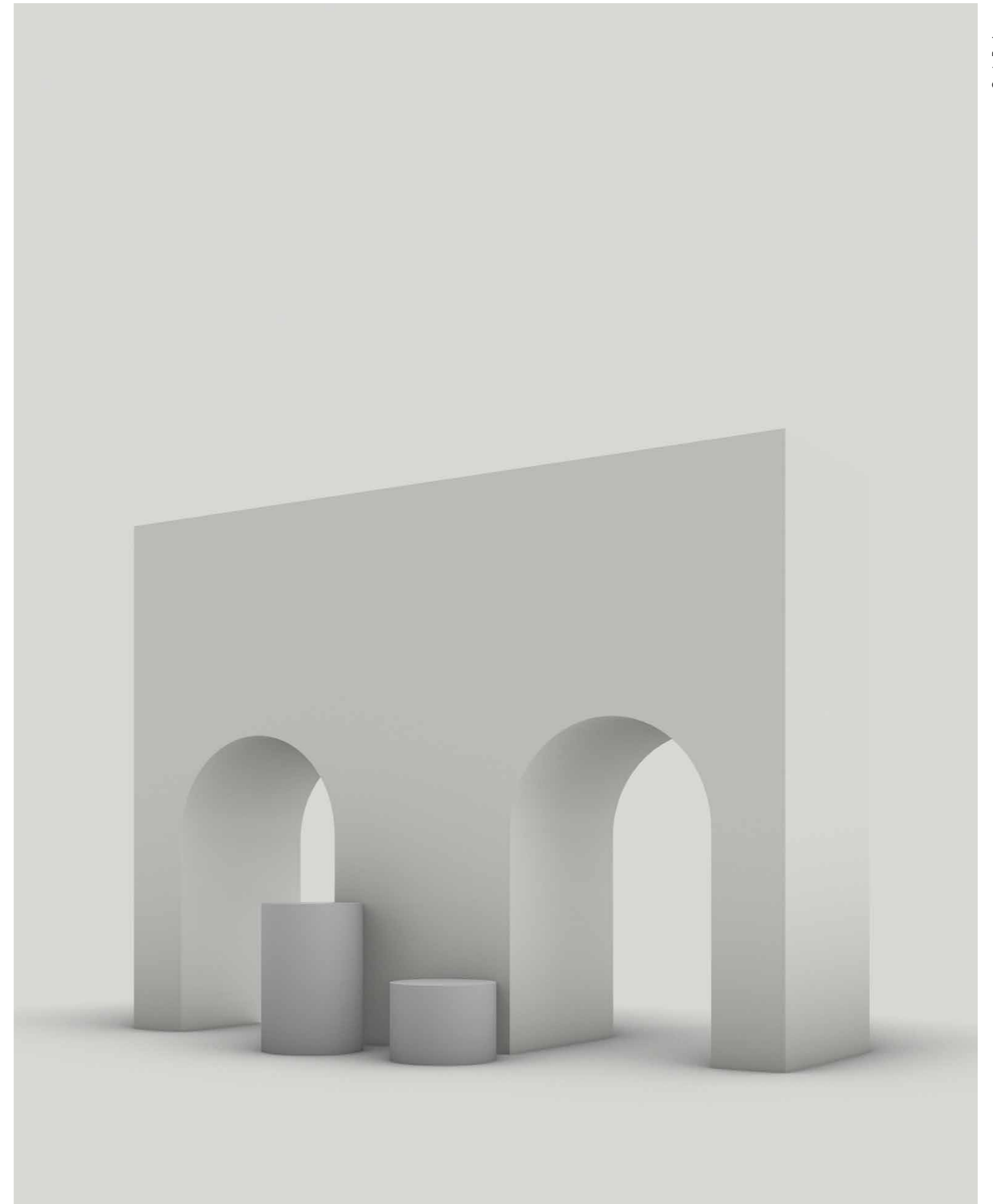







Composition made of two vanity units, top in Lightfeel with double Circle integrated washbasins, an additional base unit and a under countertop shelf with a height of 6 cm. Mirror cabinet VOLTAIRE is semi-recessed and sticks out 6 cm. The whole arrangement finds at the centre of two arches that divide the main zone from the other where you can find RIGEL bathtub and SULLIVAN side tables.

In the variant, the composition is presented in Walnut finish.

Composizione composta di due mobili portalavabo con top in lightfeel a due vasche integrate CIRCLE, da un mobile complementare e da una mensola sottolavabo alta 6 cm, mentre lo specchio contenitore VOLTAIRE è semincassato a muro e sporge di circa 6 cm. L'intera composizione è posizionata al centro di due archi che creano apertura tra la zona principale dell'ambiente e quella in secondo piano, dove sono posizionati la vasca RIGEL e i tavolini SULLIVAN.

Nella variante, la composizione è presentata in finitura Walnut.



**Composition ED_006**

Structure:
W 1,2 + 60 + 35 + 60 + 1,2 cm
D 52,5 cm
H 30 + 1,2 cm
Grey Chestnut finish

Band below the basin:
Matt "Antracite Dark" lacquered finish

Top:
Lightfeel with integrated Circle washbasin

Shelf below the basin:
Grey Chestnut finish

Wall mounted Stilo mixer with spout:
Brushed black

Voltaire mirror:
Built-in panel in Grey Chestnut finish
W 143 - D 19 - H 84 cm

Rigel bathtub:
Matt white purefeel

Freestanding bath mixer:
Brushed black

_Complements
Sullivan side tables

_Variant:
Structure and lower shelf in Walnut
Voltaire Mirror frame in Walnut

Composizione ED_006

Struttura:
W 1,2 + 60 + 35 + 60 + 1,2 cm
D 52,5 cm
H 30 + 1,2 cm
Grey Chestnut

Fascia sottolavabo:
Laccato Antracite Dark opaco

Top:
Lightfeel con vasca integrata Circle

Mensola sottolavabo:
Grey Chestnut H 6 cm

Miscelatore a parete con bocca di erogazione Stilo: Nero spazzolato

Specchiera Voltaire:
Telaio in Grey Chestnut incassato a muro
W 143 - D 19 - H 84 cm

Vasca Rigel:
Purefeel bianco opaco

Colonna miscelatore vasca da terra Stilo:
Nero spazzolato

_Complementi
Tavolini Sullivan

_Variante:
Struttura e mensola sotto lavabo in Walnut, telaio specchiera Voltaire in Walnut



EDEN_007

STATUARIETTO - WHITE CHESTNUT

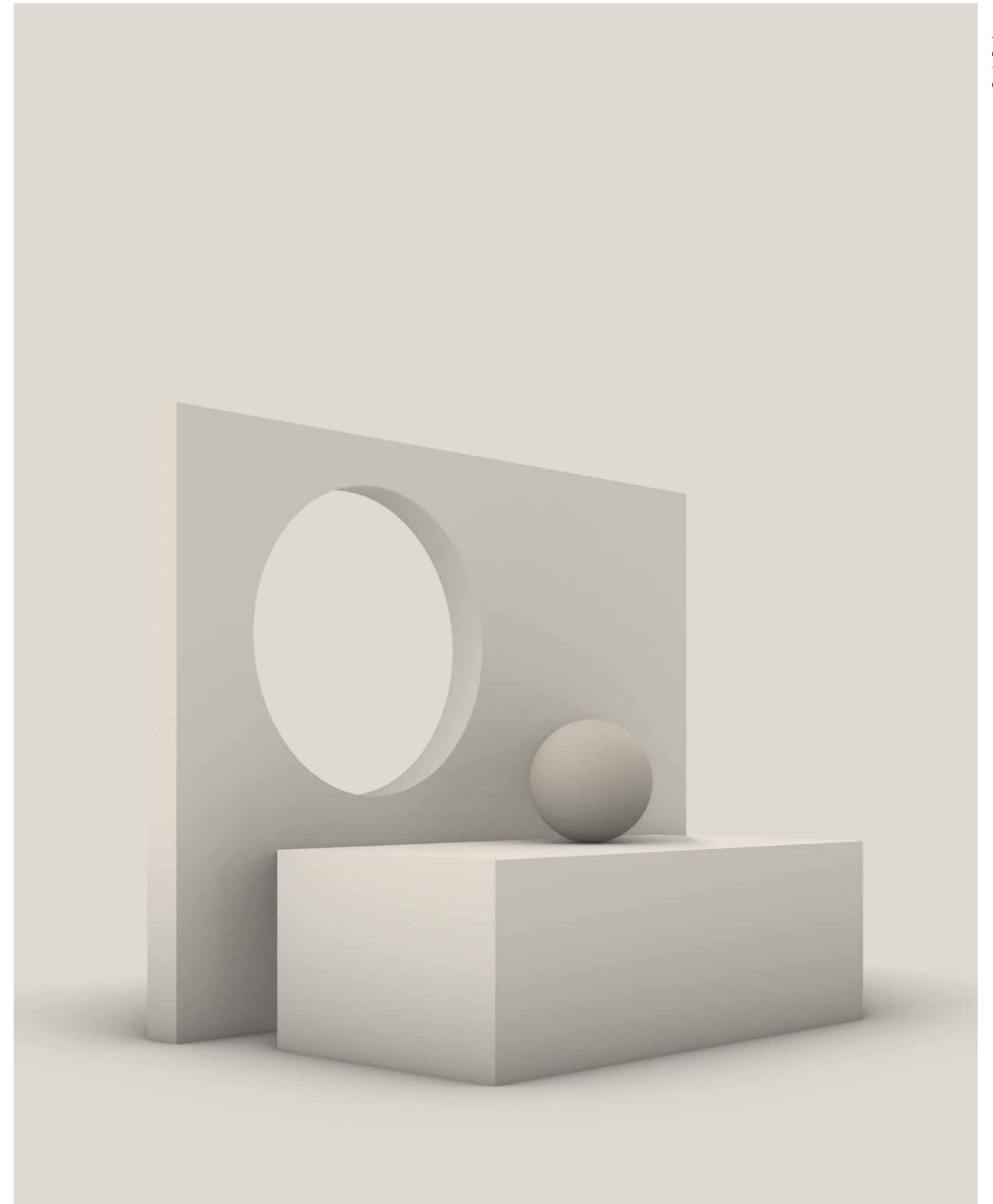







Composition made of a vanity unit, an additional wall-hung base H 50 cm. The top in Statuarietto porcelain stone with Rock integrated washbasin is 12 cm high. JOYCE mirror is provided with Led lighting and a switch and together with LUME lamp illuminate the room. The light bar "LINE" travels the perimeter of the room creating a light segment that divide the wall between the boiserie in Statuarietto porcelain stone and in White Chestnut wood. Available with frontal drawers in smooth leather P0024 and side panels in lacquered Antracite Dark.

Composizione con mobile portalavabo e uno complementare con altezza 50 + 12 cm per il top in gres Statuarietto con vasca integrata Rock. Lo specchio completo di luce led ed interruttore a sfioramento JOYCE insieme alle lampade LUME sono adibiti a fonte di luce principale, mentre la barra luminosa LINE percorre perimetralmente l'ambiente, creando un segmento luminoso che divide la parete tra le boiserie in finitura gres statuarietto e in legno White Chestnut. Disponibile in variante con frontale cassetti in Pelle P0024 liscia e fianchi in laccato Antracite Dark.



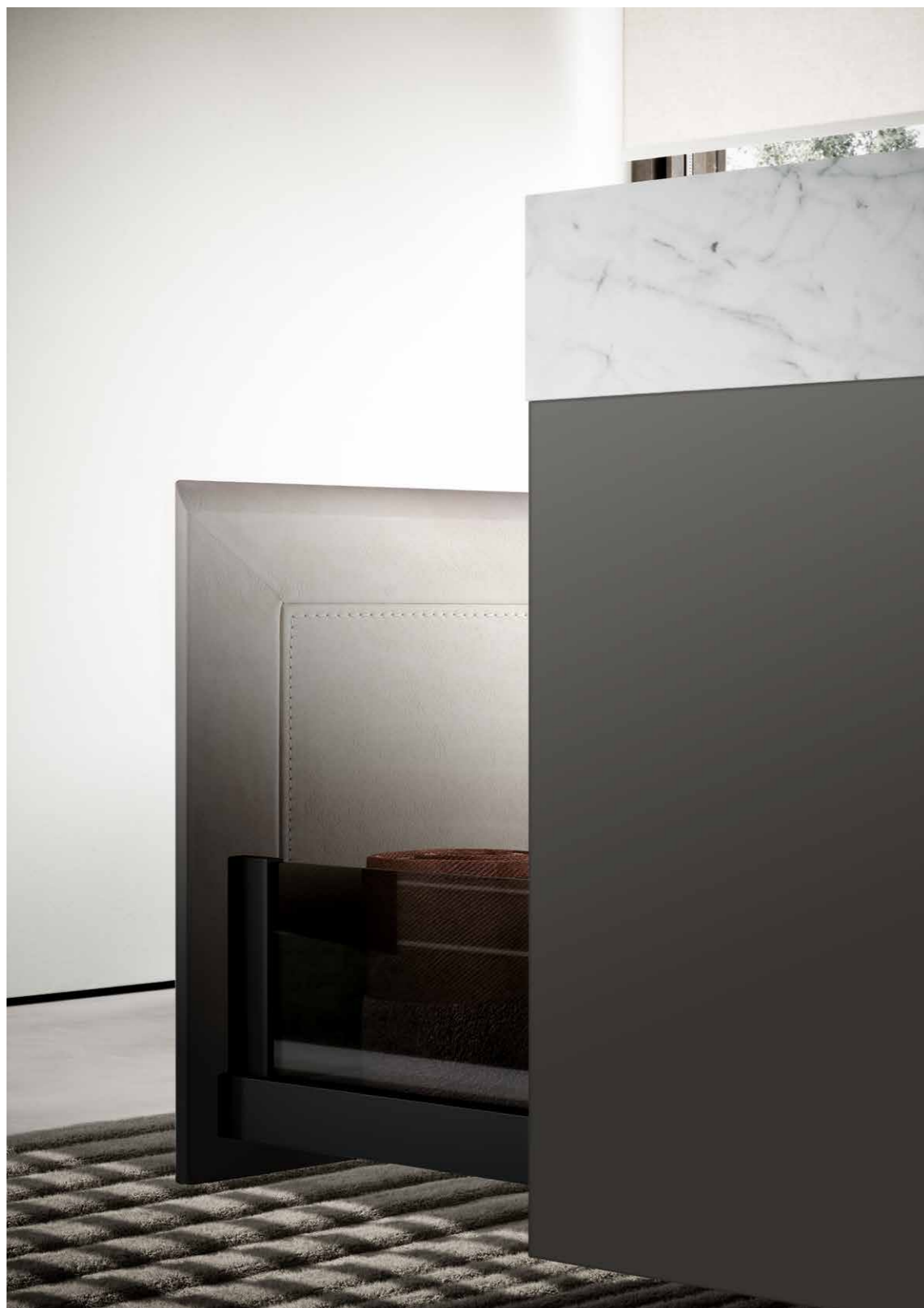

Composition ED_007

Structure:
W 1,2 + 80 + 80 + 1,2 cm
D 52,5 cm
H 50 + 12 cm
White Chestnut wooden finish

Band below the basin:
"Nero lavagna" lacquered finish

Top:
Statuarietto porcelain stone with
Rock integrated washbasin

Lume lamp:
Black

Joyce mirror:
Ø120 cm

Deck mounted single lever basin Stilo
mixer: Satin-brushed Black

Sirio bathtub:
Matt Black lacquered on the outside
Matt white Lightfeel on the inner side

Stilo freestanding bath mixer:
Satin-brushed Black

Sidney Sanitary ware (freestanding):
Matt white ceramic

Deck mounted Stilo bidet mixer:
Satin-brushed black

Line modules and panel:
satin-brushed Black aluminium frame
with glass doors

_Complementary items
Muffin Pouf

_Variant
Frontal drawers:
P0024 smooth leather
Side panels in lacquered Antracite Dark

Composizione ED_007

Struttura:
W 1,2 + 80 + 80 + 1,2 cm
D 52,5 cm
H 50 + 12 cm
White Chestnut

Fascia sottolavabo:
Laccato Nero lavagna

Top:
Gres statuarietto con vasca integrata
Rock

Lampade Lume:
Nere

Specchio Joyce:
Ø120 cm

Miscelatore lavabo Stilo:
Nero spazzolato

Vasca Sirio:
Esterno Laccato nero opaco
Interno Lightfeel bianco opaco

Colonna miscelatore vasca da terra Stilo:
Nero spazzolato

Sanitari Sidney a terra:
Ceramica bianca opaca

Miscelatore per bidet Stilo:
Nero spazzolato

Barra e moduli Line:
Alluminio nero spazzolato con ante
vetro stopsol

_Complementi
Pouf Muffin

_Variante
Frontale cassetti:
Pelle P0024 liscia
Fianchi in finitura laccata Antracite Dark

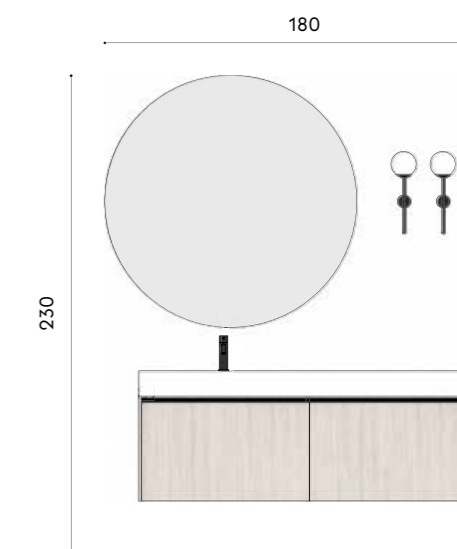

EDEN_008

GRIGIO ELEGANCE - BLACK CHESTNUT

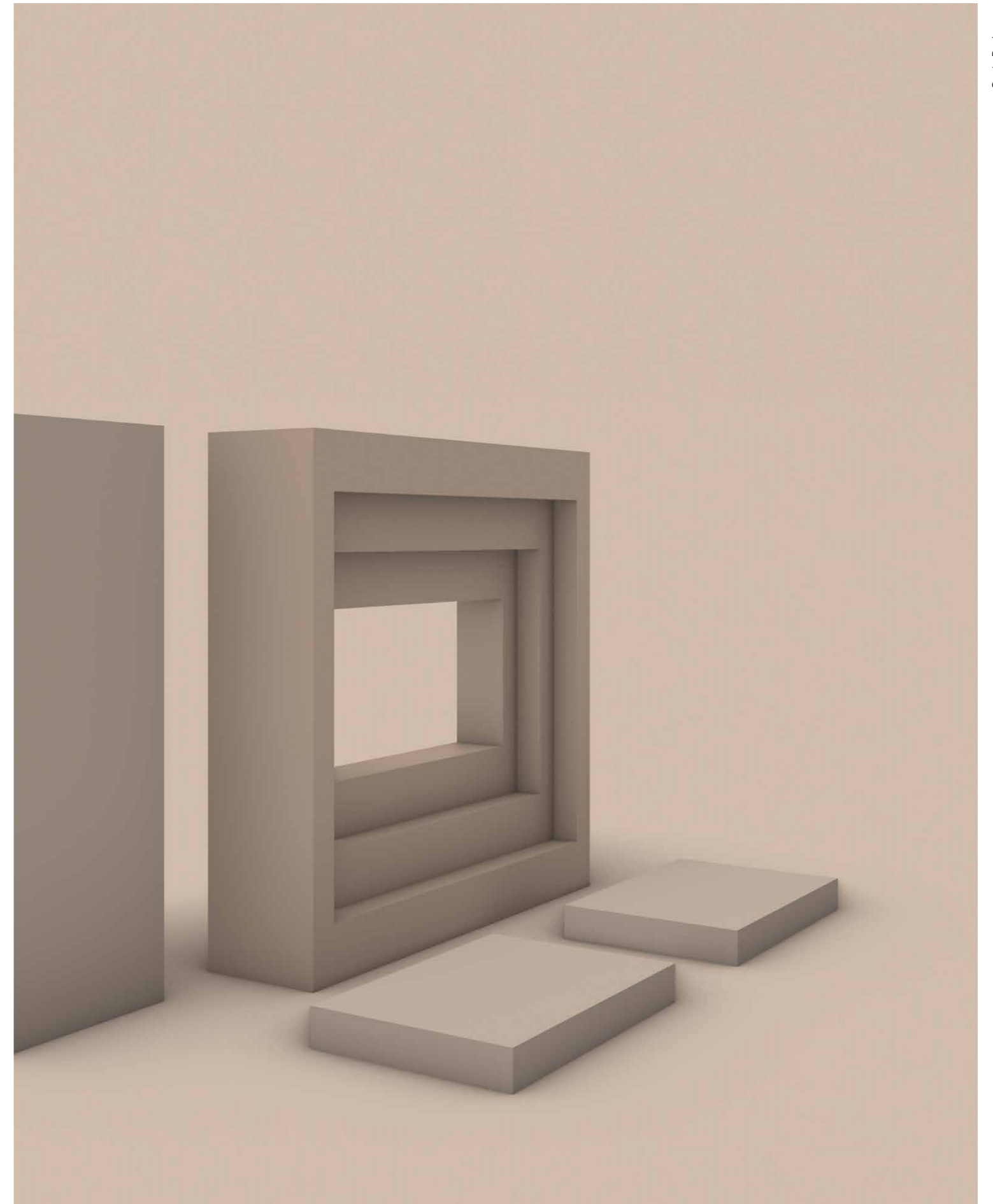







Composition made of a vanity unit and an additional wall-hung base H 51 cm both with 1 drawer and 1 inside drawer. The top is in Matt "Elegance Grey" glass finish with ROSE integrated washbasin. CHARLES mirror integrated with LED lighting and a switch and surrounded by a frame in Black Chestnut wooden finish. Its depth of 15 cm allows it to be used as a support surface. Available with Top in "Elegance Grey" purefeel with NICK integrated washbasin.

Composizione con un mobile portalavabo e uno complementare con altezza 51 cm, entrambi dotati di un cassetto e in aggiunta uno interno, il top invece è in finitura vetro laccato Grigio elegance opaco con vasca integrata ROSE. Lo specchio CHARLES, completo di luce led ed interruttore, è contornato da un telaio in finitura Black Chestnut profondo 15 cm, consentendo così di poterlo utilizzare anche come comodo piano di appoggio. Disponibile inoltre la variante con top in purefeel Grigio elegance con vasca integrata NICK.



**Composition ED_008**

Structure:
 W 1,2 + 80 + 80 + 1,2 cm
 D 52,5 cm
 H 50 + 1,2 cm
 Matt "Elegance Grey" lacquered finish

Band below the basin:
 "Nero lavagna" lacquered finish

Top:
 Glass in matt "Elegance Grey"
 lacquered finish with Rose integrated
 washbasin

Charles mirror:
 Frame in Black Chestnut wooden finish
 L 120 cm – H 80 cm

Wall unit:
 Black Chestnut wooden finish P 15 cm

Stilo mixer:
 Brushed steel

Sidney Sanitary ware (wall-hung):
 Matt white ceramic

Deck mounted Stilo bidet mixer:
 Brushed steel

Line bar and accessories:
 satin-brushed Black aluminium

_Variant

Top:
 "Grigio elegance" Purefeel with
 Nick integrated washbasin

Composizione ED_008

Struttura:
 W 1,2 + 80 + 80 + 1,2 cm
 D 52,5 cm
 H 50 + 1,2 cm
 Laccato Grigio elegance opaco

Fascia sottolavabo:
 Laccato Nero lavagna

Top:
 Vetro laccato Grigio elegance satinato
 con vasca integrata Rose

Specchio Charles:
 Telaio in Black Chestnut
 L 120 cm – H 80 cm

Pensile:
 Black Chestnut
 P 15 cm

Miscelatore lavabo Stilo:
 Acciaio spazzolato

Sanitari Sidney sospesi:
 Ceramica bianca opaca

Miscelatore per bidet Stilo:
 Acciaio spazzolato

Barra Line e accessori:
 Alluminio nero spazzolato

_Variante

Top:
 Purefeel Grigio Elegance con vasca
 integrata Nick

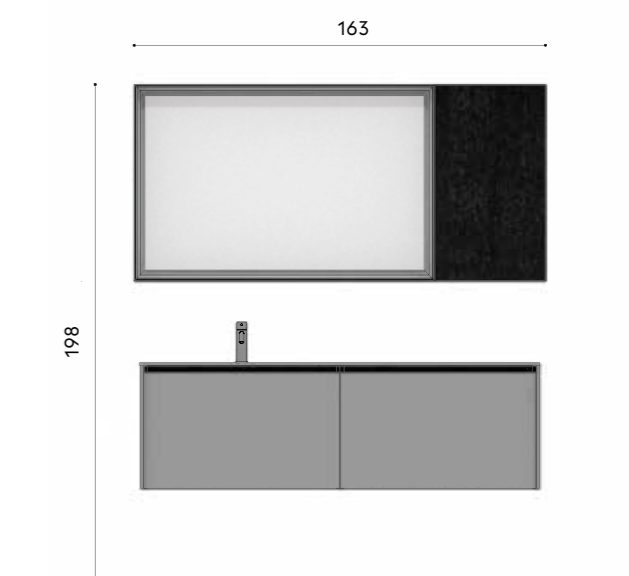

EDEN_009
BLACK FENIX AND GREEN



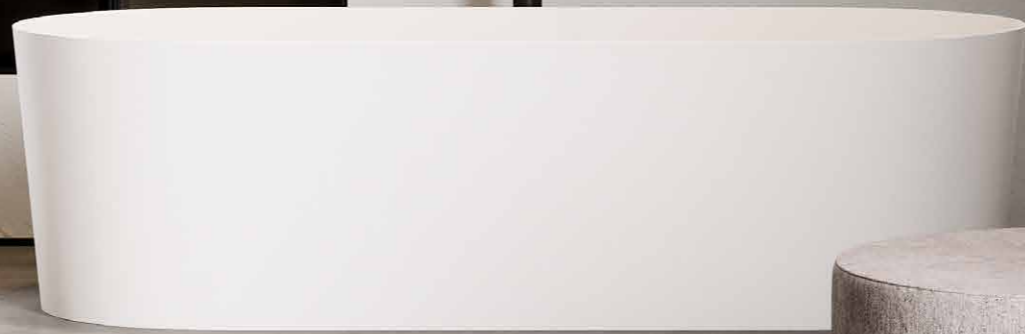



Composition made of three complementary units with drawers, top in Fenix with Hanna integrated washbasin with a height of 12 cm. DREAM mirror in black metal with integrated LED lighting illuminate the room. LINE bar can be customized and with 90° joints; in this way the element follows the architectural structure of the room. ALU tall units matches with MIZAR bathtub in matt white Lightfeel as opposed to the dark finishes of the arrangement. MARLENE side tables and KIM pouf are the complements chosen to enrich the room.

Composizione composta da tre mobili complementari con cassetti e da un top in Fenix con vasca integrata Hanna alto 12 cm, il tutto illuminato dallo specchio DREAM in metallo nero, dotato di illuminazione a led. Il profilo della barra LINE è disponibile inoltre tagliato su misura e con giunzioni a 90°, consentendo all'elemento di seguire i volumi architettonici della stanza. Le colonne ALU sono abbinata alla vasca MIZAR in lightfeel bianco opaco che dona un accento di luminosità all'ambiente, in contrasto con i toni scuri della composizione. I complementi scelti per arricchire l'ambiente sono i tavolini MARLENE e i pouf KIM.



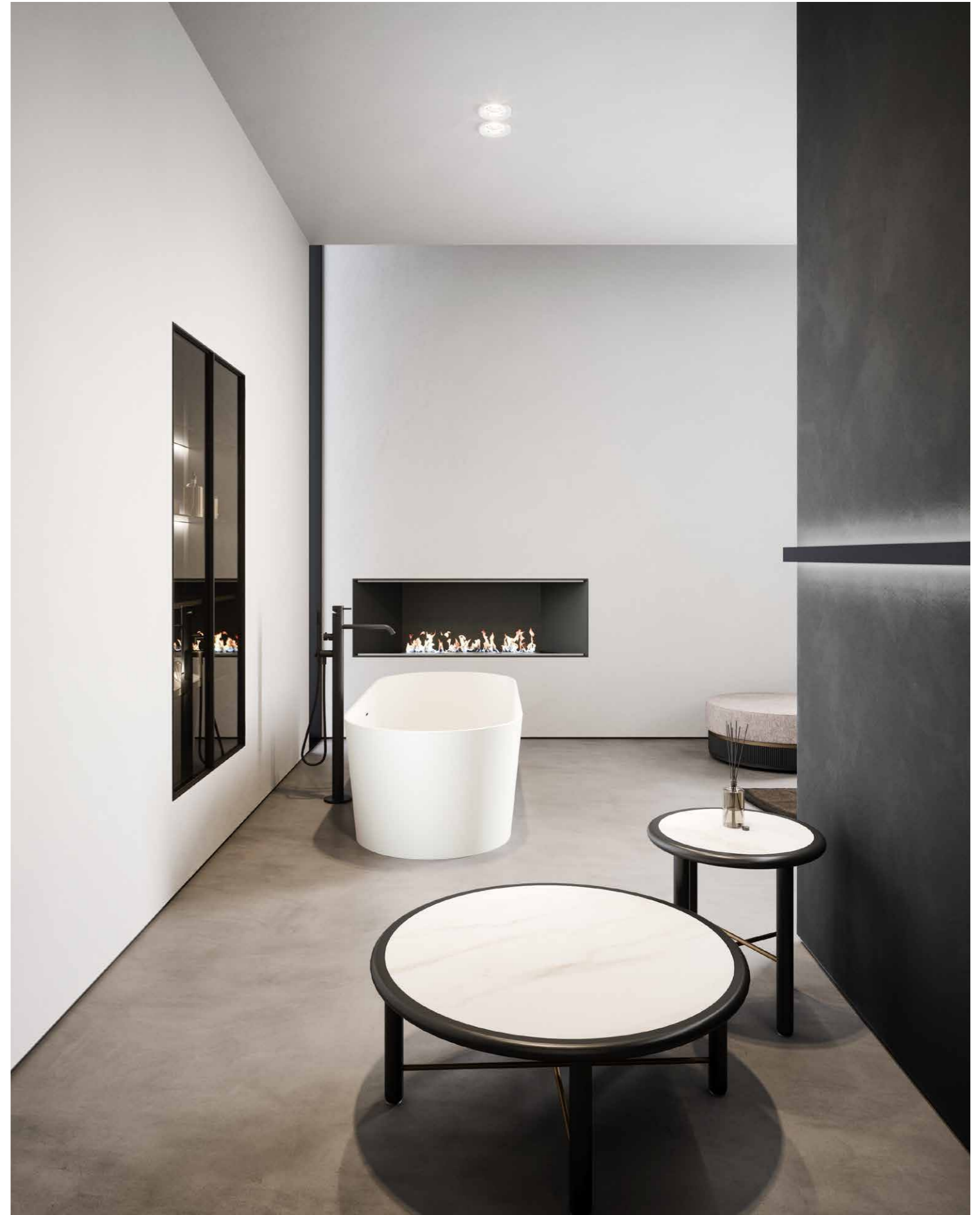

**Composition ED_009**

Top:
in Black Fenix with integrated
Hanna washbasin
L 120 cm H 12 cm

Complementary units:
W 1,2 + 60 + 60 + 60 + 1,2 cm
D 52,5 cm
H 30 + 1,2 cm
Top in Black Fenix finish with frontal
drawers in Green lacquered finish

**Deck mounted spout and Stilo deck
mounted mixer:**
Brushed black

Dream mirror:
Ø90 cm

Line bar, modules and accessories:
Brushed black Aluminium

**Alu tall units with integrated LED
lighting behind the shelves:**
Panel in Brushed black Aluminium with
black back and smoked glass doors
H 162 cm

Mizar bathtub:
Matt white lightfeel

Stilo Freestanding bath mixer:
Brushed black

_Complements
Marlene side tables
Kim pouf

Composizione ED_009

Top:
in Black Fenix con lavabo integrato
Hanna
L 120 cm H 12 cm

Basi complementari:
W 1,2 + 60 + 60 + 60 + 1,2 cm
D 52,5 cm
H 30 + 1,2 cm
Top in finitura Black Fenix con cassetti
frontali in finitura Verde laccato

**Bocca di erogazione e miscelatore
monocomando Stilo:**
Nero spazzolato

Specchio Dream:
Ø90 cm

Barra Line, moduli e accessori:
Alluminio nero spazzolato

**Colonne Alu con luce led integrata
dietro i ripiani:**
Telaio in alluminio nero spazzolato con
schiena nera e ante in vetro fumè
H 162 cm

Vasca Mizar:
Lightfeel bianco opaco

Colonna miscelatore vasca da terra Stilo:
Nero spazzolato

_Complementi
Tavolini Marlene
Pouf Kim

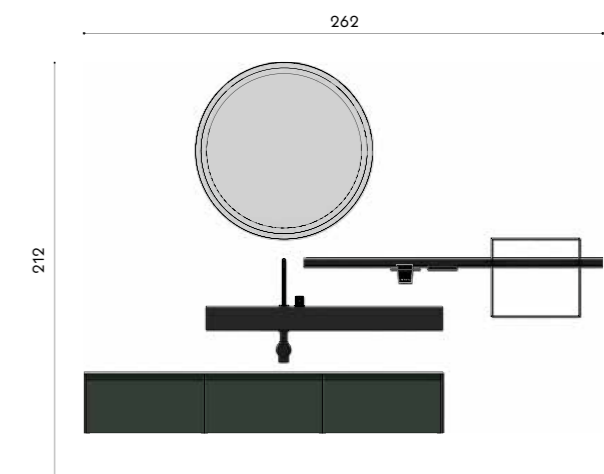

EDEN_010

PAPIRO GLASS







Composition made of a vanity unit and two additional bases in coloured ribbed glass with a height of 51 cm and top in matt Papiro lacquered finish with ROSE integrated washbasin. Next to DALÌ mirror and behind LUME lamps there is a shelf, 4 cm depth, in matt Papiro lacquered finish. The composition finds inside a niche with a sloping ceiling in a bleached oak finish. It confers the room a Nordic taste. Two MUFFIN poufs complete the room.

Composizione con un mobile portalavabo e due mobili complementari in vetro cannettato colorato con altezza 51 cm con top in vetro laccato Papiro lucido e vasca integrata ROSE. Alla presenza delle lampade LUME a sospensione e dello specchio DALÌ è affiancata una mensola di spessore 4 cm in finitura laccato Papiro opaco. La composizione è inserita all'interno di una nicchia dal soffitto spiovente in finitura Rovere sbiancato in grado di conferire all'ambiente un gusto nordico. A completare la stanza è presente una coppia di pouf MUFFIN.

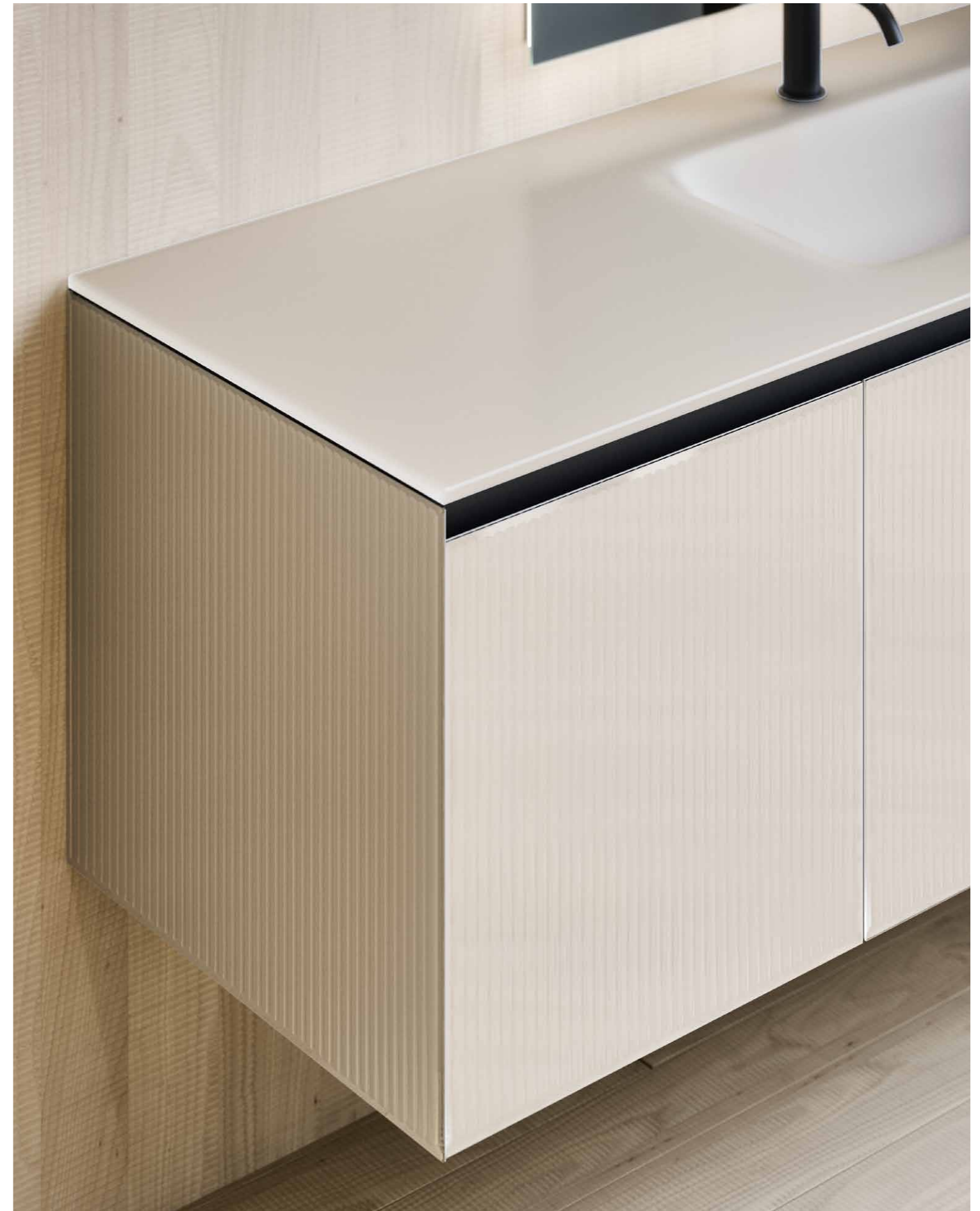

**Composition ED_010**

Structure:
 W 0,5 + 45 + 70 + 70 + 0,5 cm
 D 52,5 cm
 H 50 + 1,2 cm
 Glossy Papiro lacquered ribbed glass

Band below the basin:
 Nero Lavagna lacquered finish

Top:
 Glossy Papiro lacquered glass with
 Rose integrated washbasin

**Deck mounted single lever basin Stilo
 mixer: Brushed black**

Easy mirror:
 W 60 - H 108 cm

Lume suspended lamp:
 Black

Shelf:
 Matt Papiro lacquered finish

**_ Complements
 Muffin Pouf**

Composizione ED_010

Struttura:
 W 0,5 + 45 + 70 + 70 + 0,5 cm
 D 52,5 cm
 H 50 + 1,2 cm
 Vetro cannettato laccato Papiro lucido

Fascia sottolavabo:
 Laccato Nero lavagna

Top:
 Vetro laccato Papiro lucido con vasca
 integrata Rose

Miscelatore lavabo Stilo:
 Nero spazzolato

Specchio Dali Full:
 W 60 - H 108 cm

Lampade Lume a sospensione:
 Nero

Mensola:
 Laccato Papiro opaco H 4 cm

**_Complementi
 Pouf Muffin**

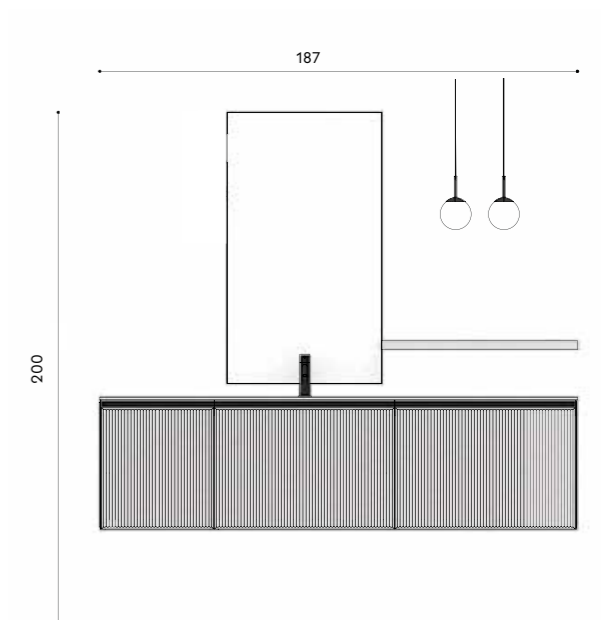

EDEN_011

AVANA GLASS - HEAT TREATED OAK

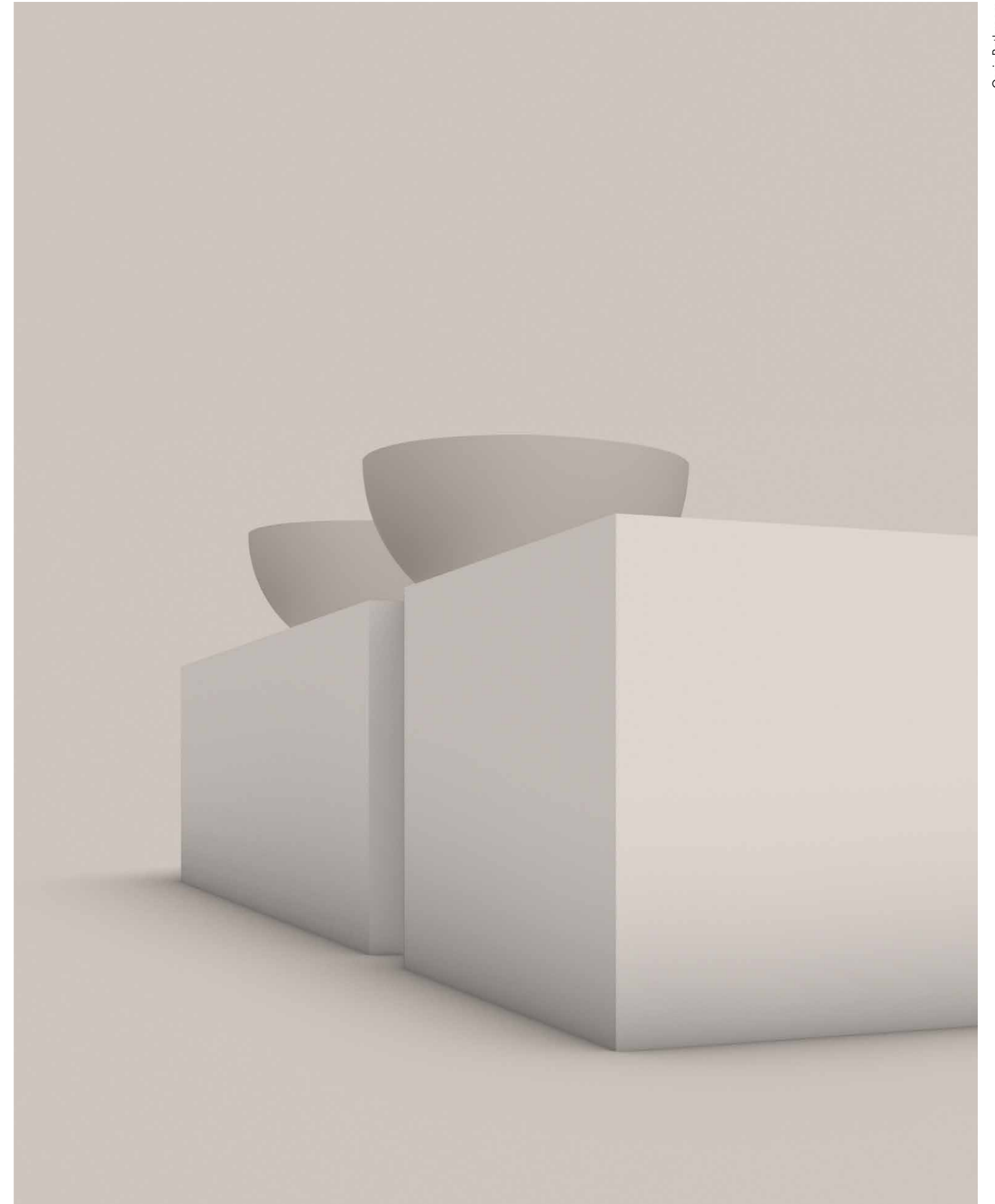





Composition made of two vanity units and an additional wall mounted base unit in coloured glossy Avana glass with open compartment integrated with LED lighting. The height is 31 cm. AMY washbasins in glossy white ceramic match with STILO taps in brushed steel. The extension is in "Avana" gloss lacquered glass finish. DALÍ FULL mirror has the same length of the vanity unit. SEI is a burnished lamp with a narrow and elongated shape. CUBE built-in tall units, with HOLY metallic handles in matt bronze, have a depth of 33 cm and heat-treated oak finish.

Composizione composta da due mobili portalavabo e da un vano a giorno in vetro colorato Avana lucido con luce led integrata, il tutto ad altezza 31 cm. I lavabi AMY in ceramica bianca lucida sono abbinati ai rubinetti Stilo in acciaio spazzolato con alzata in finitura vetro laccato Avana lucido, mentre lo specchio DALÍ FULL percorre tutta la lunghezza del mobile. Ad incoronare la composizione troviamo la lampada SEI brunita che, grazie alla sua forma stretta ed allungata, rimane coerente alle linee della composizione. Le colonne CUBE profondità 33 cm in finitura Heat Treated Oak con maniglie HOLY metallizzate bronzo opaco, sono incassate a parete e creano ulteriore spazio di contenimento, fondendosi perfettamente.



**Composition ED_011**

Structure:
 W 0,5 + 90 + 90 + 45 cm
 D 52,5 cm
 H 30 + 1,2 + 30 cm
 "Avana" gloss lacquered glass

Band below the basin:
 "Avana" gloss lacquered finish

Top:
 "Avana" gloss lacquered glass

Additional wall mounted base unit with open compartment integrated with LED lighting: Heat-treated oak

Amy washbasin:
 Glossy white ceramic H 13 cm

Dali Full Mirror:
 L 227 cm - H 105 cm

Sei lamp:
 Burnished

Stilo mixer:
 Brushed steel

Cube tall units:
 Heat-treated oak H 120 cm
 Holy metallic handles in matt bronze
 Top under the tall units in heat-treated oak

Composizione ED_011

Struttura:
 W 0,5 + 90 + 90 + 45 cm
 D 52,5 cm
 H 30 + 1,2 + 30 cm
 Vetro laccato Avana lucido

Fascia sottolavabo:
 Laccato Avana lucido

Top:
 Vetro laccato Avana lucido

Vano a giorno con luce led integrata:
 Heat Treated Oak

Lavabo Amy:
 Ceramica bianca lucida
 H 13 cm

Specchio Dali Full:
 L 227 cm - H 105 cm

Lampada Sei:
 Brunito

Miscelatori lavabo Stilo:
 Acciaio spazzolato

Colonne Cube:
 Heat Treated Oak H 120 cm
 Maniglie Holy Metallizzate in bronzo opaco
 Top sottocolonne in Heat Treated Oak

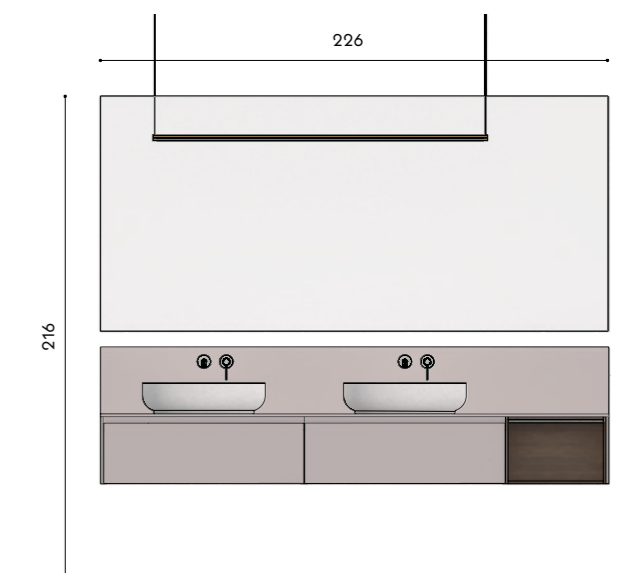

EDEN_012

FOKOS ROCCIA - BLACK CHESTNUT

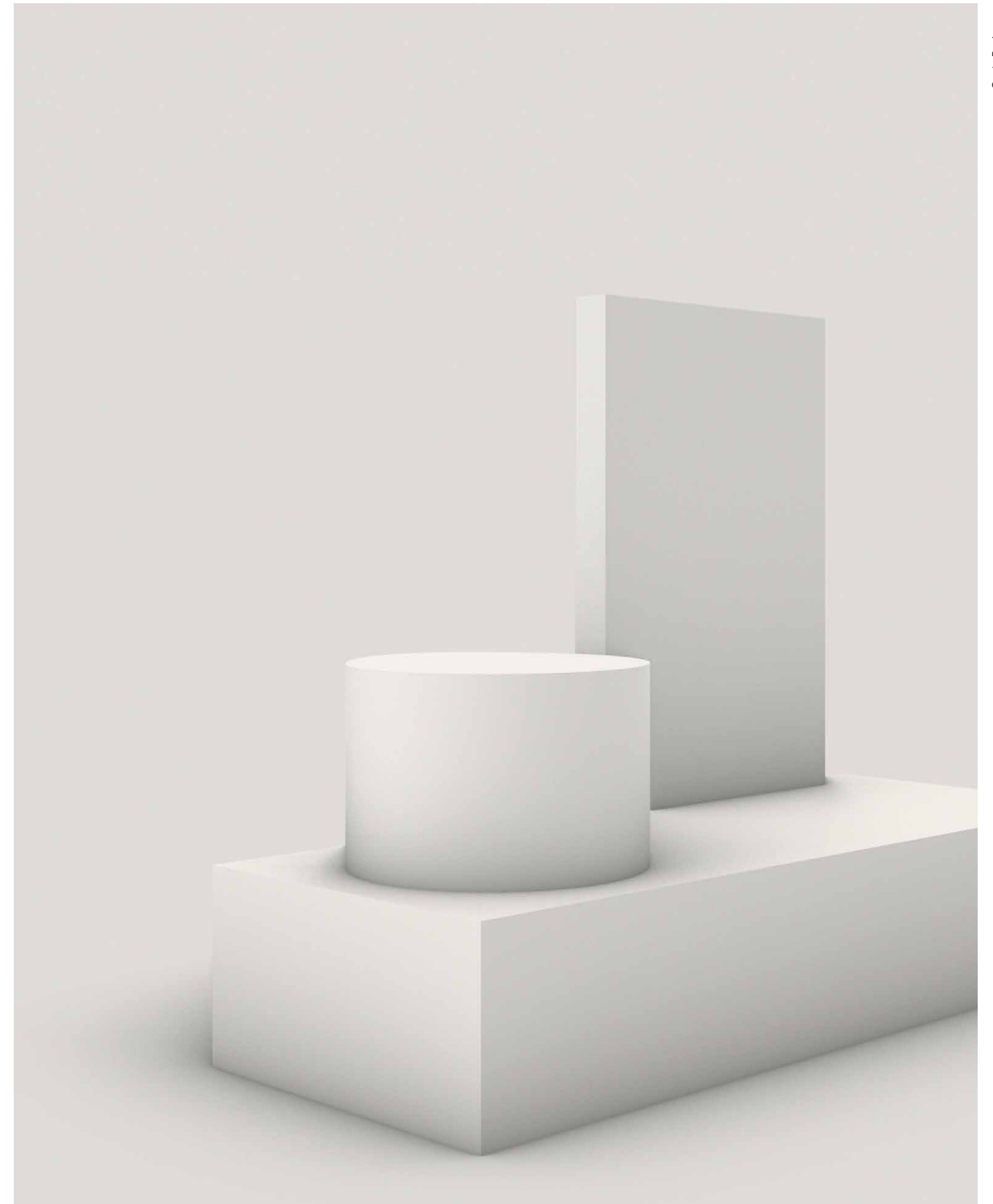





Composition made of a vanity unit and an additional wall mounted base unit H 31 cm. Side panels and top in "Focos Roccia" porcelain stone, frontal drawers in leather P0023 in Deluxe version. Julia washbasin is in black purefeel; Stilo washbasin, LINE bar and LUME lamp have the same colour. In front of the composition there are two open-shelving wall unit and next to them there are tall units with ALU glass doors. The room has an elegant touch thanks to the boiserie in Black Chestnut and "Focos Roccia" porcelain stone. MIZAR bathtub in matt white together with LINE bar equipped with hooks creates a modern room. It is possible to choose for CUBE tall unit instead of the ALU ones. They are 120 cm high in glossy Avana lacquered finish.

Composizione con un mobile portalavabo e uno complementare con altezza 31 cm. Fianchi e top in gres "Focos Roccia", frontali in pelle P0023 in versione Deluxe. Il lavabo JULIA in finitura purefeel colore nero viene accostato ad altri elementi in medesimo colore come il rubinetto Stilo, la barra LINE e le lampade LUME. Frontalmente alla composizione troviamo i due vani a giorno OPEN sovrapposti e affiancati da colonne con ante vetro ALU, entrambi incassati a muro. L'ambiente nel complesso acquista un gusto elegante grazie alle pareti rivestite da boiserie in Black Chestnut e gres Focos Roccia, e al contempo moderno, caratteristica suggerita dalla presenza della vasca MIZAR dalle forme pulite e lineari in purefeel bianco opaco, che viene abbinata al tocco luminoso della barra LINE fornita di ganci per accappatoi. In sostituzione alle colonne ALU è disponibile una variante con colonne CUBE alte 120 cm in finitura laccato Avana lucido.



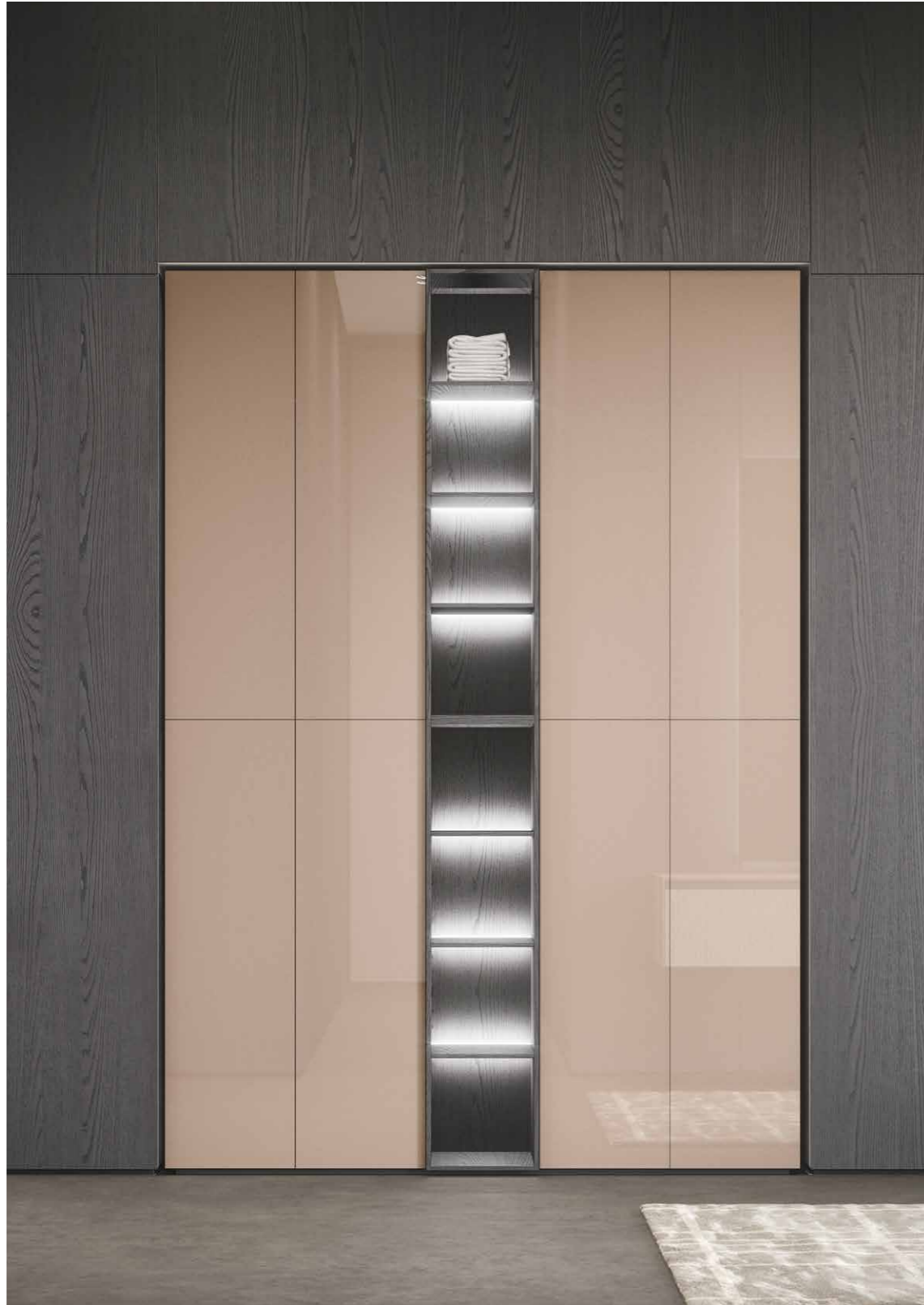

**Composition ED_012**

Structure:
W 1,2 + 90 + 90 + 1,2 cm
D 52,5
H 30 + 1,2 cm
Top and side panels in "Focos Roccia" porcelain stone

Frontal drawers:
Woven leather P0023 in Deluxe version

Band below the basin:
"Nero Lavagna" finish

Top:
"Focos Roccia" porcelain stone

Julia washbasin:
Black purefeel

Stilo mixer:
brushed Black

Dali Full mirror:
L 60 cm – H 140 cm

Line bar and accessories:
Brushed Black aluminium

Lume suspended lamp:
"Nero Lavagna" finish

Alu tall units with integrated LED lighting behind the shelves:
Panel in brushed Black aluminium with Black Chestnut back and smoked glass doors H 120 cm

Open base unit with open compartment integrated with LED lighting behind the shelves:
Black Chestnut
H 120 cm

Mizar bathtub:
Matt white Lightfeel

Stilo freestanding bath mixer:
Brushed Black

Sidney Sanitary ware (freestanding):
Matt white ceramic

Deck mounted Stilo bidet mixer:
brushed black

_Variant
Cube tall units
Glossy Avana lacquered finish H 120 cm

Composizione ED_012

Struttura:
W 1,2 + 90 + 90 + 1,2 cm
D 52,5
H 30 + 1,2 cm
Top e fianchi in Gres Focos Roccia

Frontali cassetti:
Pelle intreccio P0023 in versione Deluxe

Fascia sottolavabo:
Finitura in "Nero Lavagna"

Top:
Gres Focos Roccia

Lavabo Julia:
Purefeel colore nero

Miscelatore lavabo Stilo:
Nero spazzolato

Specchio Dali Full:
L 60 cm – H 140 cm

Barra Line e accessori:
Alluminio nero spazzolato

Lampada Lume a sospensione:
Finitura "Nero Lavagna"

Colonne Alu con luce led integrata dietro i ripiani:
Telaio in alluminio nero spazzolato con schiena in Black Chestnut con ante in vetro fumè H 120 cm

Vani a giorno Open con luce led integrata dietro i ripiani:
Black Chestnut
H 120 cm

Vasca Mizar:
Lightfeel bianco opaco

Colonna miscelatore vasca da terra Stilo:
Nero spazzolato

Sanitari Sidney a terra:
Ceramica bianca opaca

Miscelatore per bidet Stilo:
Nero spazzolato

_Variante
Colonne Cube:
Laccato Avana lucido
H 120 cm



EDEN_013

ROSSO JAIPUR - WHITE CHESTNUT

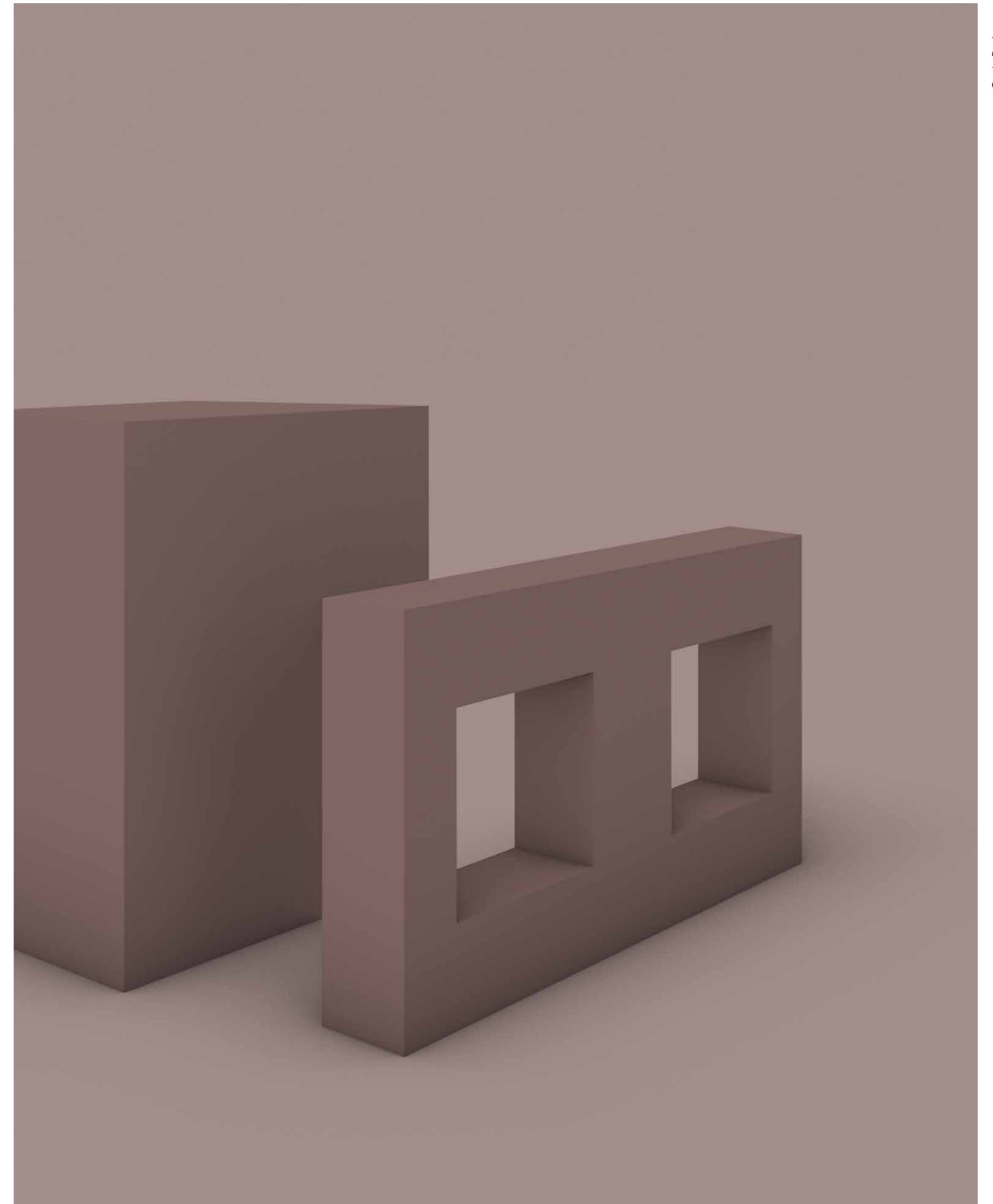







Composition made of two additional wall mounted base and a top with two integrated washbasins in Rosso Jaipur Fenix finish. Height of 12 cm. The modularity of the arrangement includes ACCA mirror with integrated LED lighting and a switch. Its depth of 15 cm allows it to be used as a support surface. In order to complete the room there are also ALU tall units, CUBE tall units with a handle at the center of the door and HAMAL bathtub in matt white purefeel.

Composizione composta da due mobili complementari e da un top con due vasche integrate in Fenix Rosso Jaipur con altezza 12 cm. La composizione modulare viene completata dallo specchio ACCA con luce led integrata ed interruttore, che, con le sue mensole e la profondità del telaio di 15 cm è in grado di creare ulteriori spazi di appoggio. A completare l'ambiente troviamo le colonne ALU, le colonne CUBE con maniglia posizionata al centro dell'anta e la vasca HAMAL in finitura purefeel bianco opaco.



**Composition ED_013**

**Top with integrated washbasin in Fenix:
Rosso Jaipur Fenix with Hanna
integrated washbasin**
L 210 cm H 12 cm

Complementary units:
W 1,2 + 105 + 105 + 1,2 cm
D 52,5 cm
H 30 + 1,2 cm
White Chestnut wooden finish

Stilo wall mounted mixer with spout:
Brushed black

Acca Mirror:
Black panel
L 212 cm – H 80 cm

Hamal bathtub:
Matt white purefeel

**Stilo deck mounted single lever basin
mixer:**
Brushed black

Cube tall units:
Bleached chestnut wooden finish
H 162 cm
Mauri metallic handles in matt black

**Alu tall units with integrated LED
lighting behind the shelves:**
Brushed black Aluminium panel with
Black back and smoked glass doors
H 162 cm

Composizione ED_013

**Top con vasche integrate in Fenix:
Fenix Rosso Jaipur con lavabo
integrato Hanna**
L 210 cm H 12 cm

Base complementare:
W 1,2 + 105 + 105 + 1,2 cm
D 52,5 cm
H 30 + 1,2 cm
Finitura in legno White Chestnut

**Miscelatore a parete con bocca di
erogazione Stilo:**
Nero spazzolato

Specchio Acca:
Telaio Nero
L 212 cm – H 80 cm

Vasca Hamal:
Purefeel bianco opaco

Miscelatore vasca da appoggio Stilo:
Nero spazzolato

Colonne Cube:
Castagno sbiancato
H 162 cm

Maniglie Mauri:
Nero opaco

**Colonne Alu con luce led integrata
dietro i ripiani:**
Telaio in alluminio nero spazzolato con
schiena Nera con ante in vetro fumè
H 162 cm

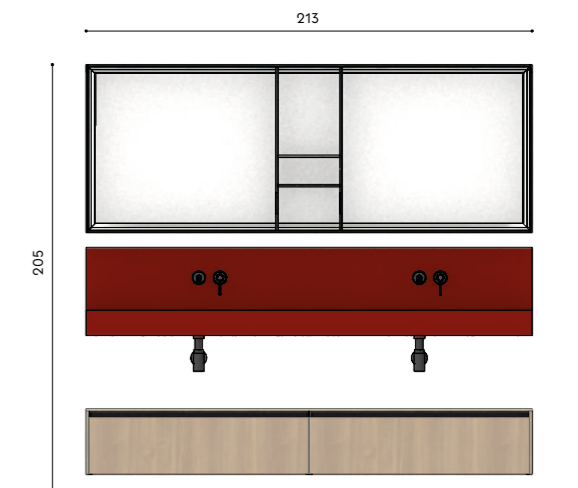

EDEN 014

JATOBA BROWN - SABBIA

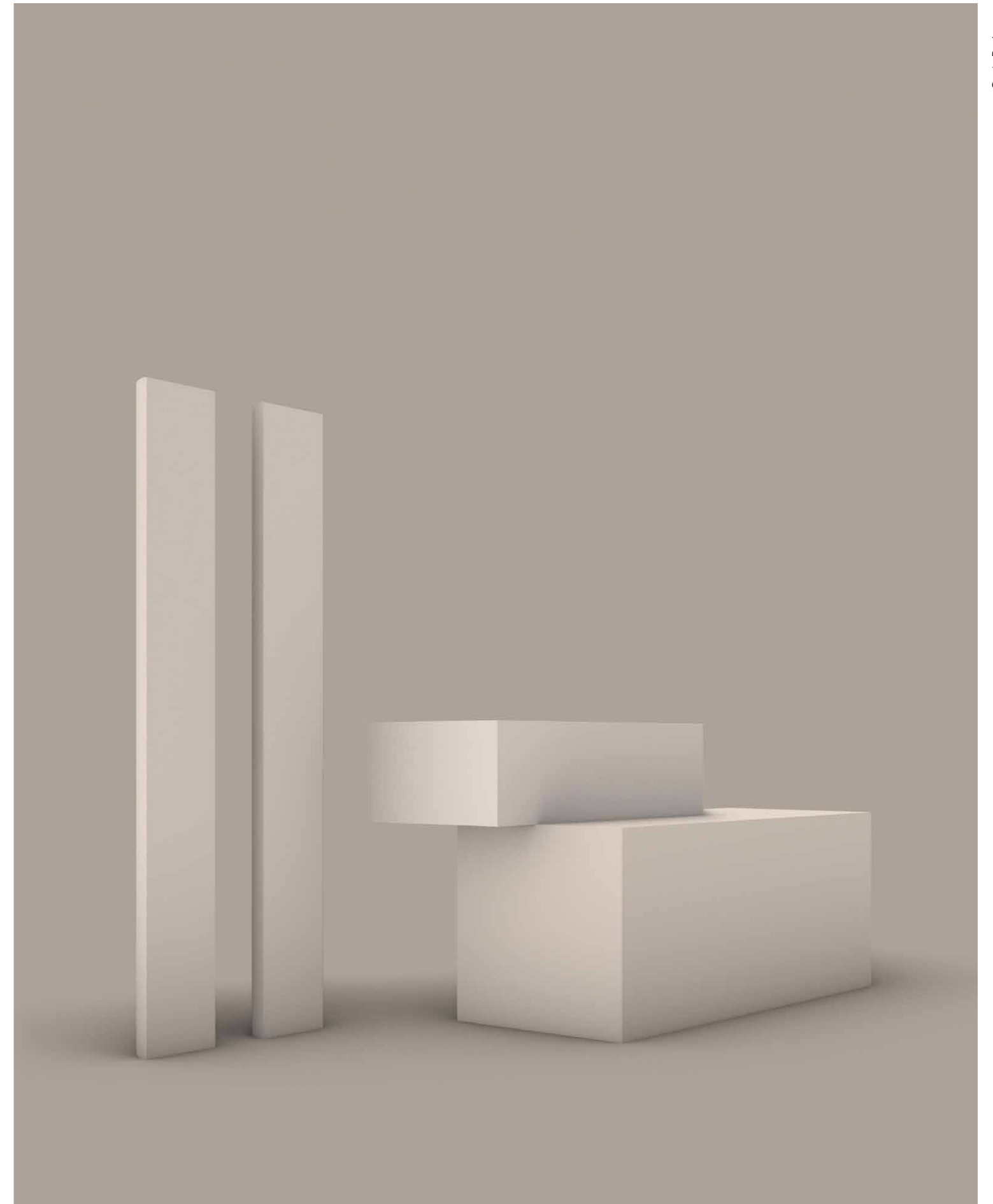





Composition made of three additional base and a top with Rock integrated washbasin in "Jatoba Brown" porcelain stone H 12 cm. EASY mirror matches with TETRIS DX lamp and LINE bar (equipped with modules and accessories). The bathroom area included MIZAR two-tone bathtub, LUME lamps and AVA armchair.

Composizione composta da tre mobili complementari a terra e da un top con vasca Rock integrata in gres "Jatoba Brown" con altezza 12 cm. Lo specchio EASY è abbinato alla lampada TETRIS DX e alla barra LINE, completa di moduli e accessori. La zona bagno è completata dalla vasca MIZAR bicolore in abbinata alle lampade LUME e alle poltrone AVA.



**Composition ED_014**

Top with Rock integrated washbasin:
 "Jatoba brown" porcelain stone
 L 125 cm H 12 cm

Complementary units:
 W 1,2 + 80 + 45 + 80 + 1,2 cm
 D 52,5 cm
 H 3 + 50 + 1,2 cm
 Glossy "Sabbia" lacquered finish

Plinth:
 Black finish

Stilo Wall mounted mixer with spout:
 brushed black

Easy mirror:
 L 120 cm - H 80 cm

Tetris dx lamp:
 brushed black

Lume lamp:
 Black finish

Line bar, modules and accessories:
 brushed black

Mizar bathtub:
 Matt "Nero lavagna" lacquered finish on
 the outside
 Matt white Purefeel on the inner side

Freestanding bath mixer:
 brushed black

_Complements
 Ava armchair

Composizione ED_014

Top con vasca integrata Rock:
 Gres in "Jatoba brown"
 L 125 cm H 12 cm

Basi complementari:
 W 1,2 + 80 + 45 + 80 + 1,2 cm
 D 52,5 cm
 H 3 + 50 + 1,2 cm
 Laccato "Sabbia" lucido

Zoccolo:
 Black finish

**Miscelatore a parete con bocca di
 erogazione Stilo: Nero spazzolato**

Specchio Easy:
 L 120 cm - H 80 cm

Lampada Tetris dx: Nero spazzolato

Lampade Lume:
 Nero

Barra Line, moduli e accessori:
 Nero spazzolato

Vasca Mizar:
 Esterno Laccato Nero lavagna opaco
 Interno Purefeel bianco opaco

Colonna miscelatore vasca da terra Stilo:
 Nero spazzolato

_Complementi
 Poltrone Ava

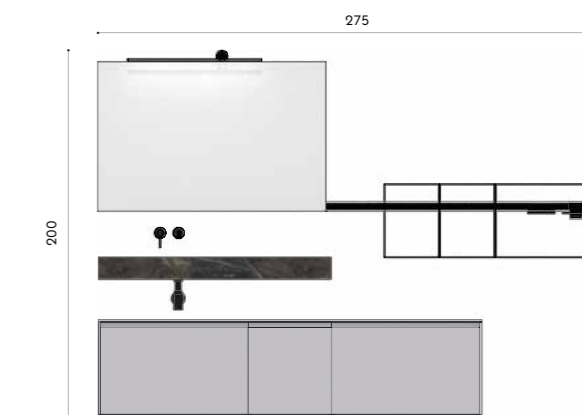

EDEN_015

CAFFÈ ELEGANCE - WALNUT

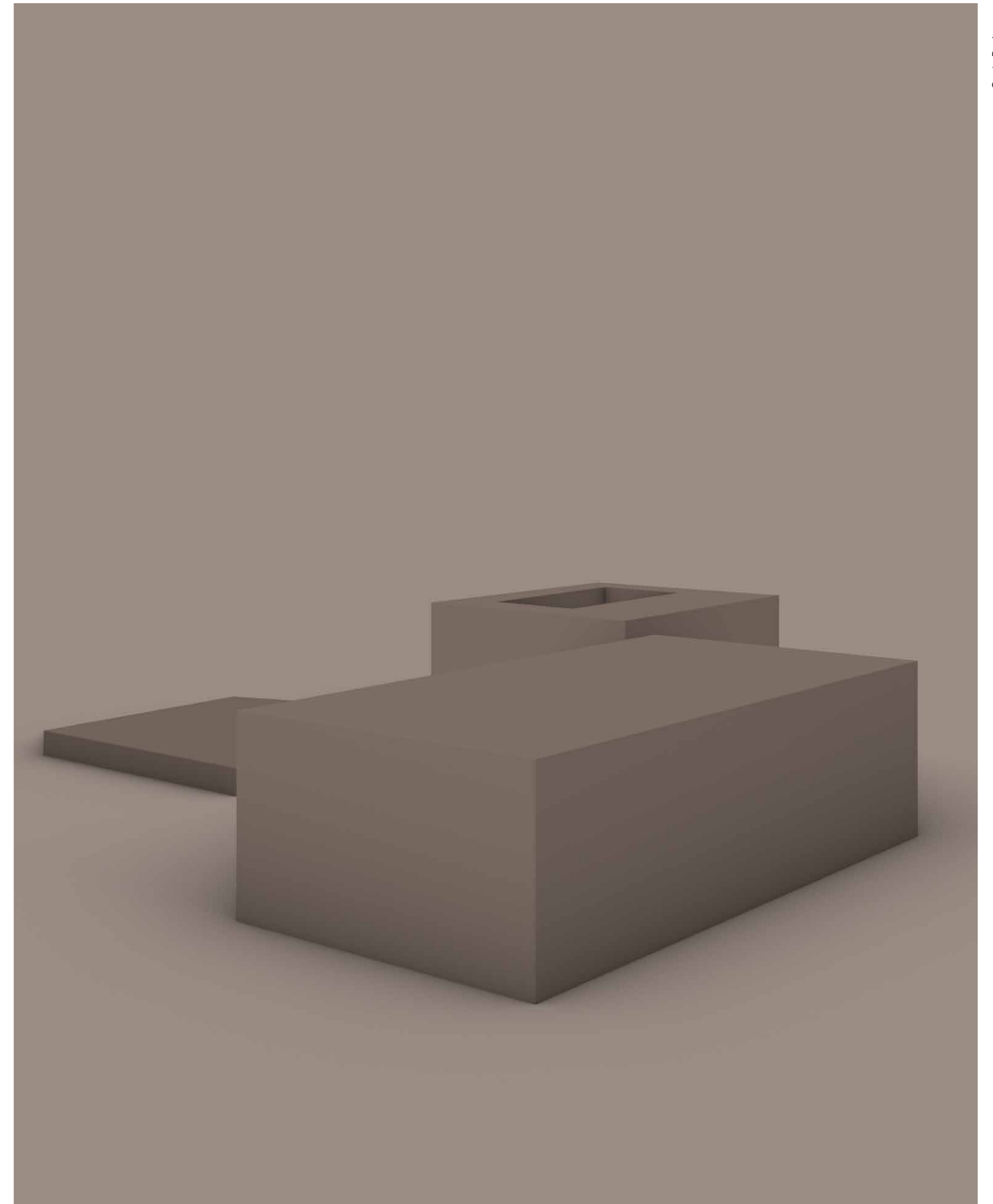







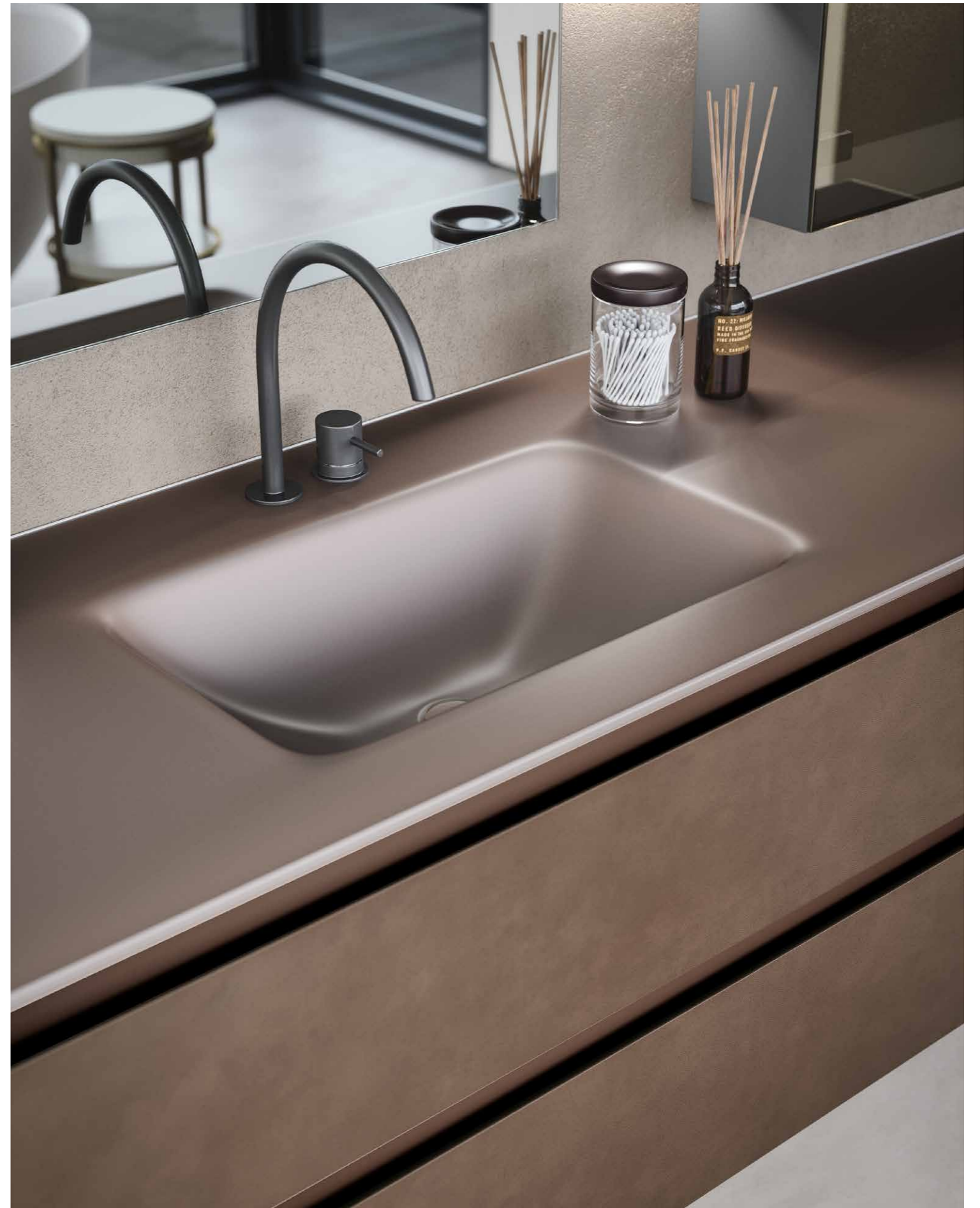

Composition made of a vanity unit and an additional base with a height of 51 cm. The frontal drawers are in smooth leather P0027 and they give a touch of originality while LUME lamp and LINE bar illuminate the entire environment. In front of the arrangement there is VEGA bathtub in matt white Lightfeel and two overlapping OPEN open-shelving wall units with a height of 120 cm. MEDEA side tables and KIM pouf complete the room. The arrangement is available with a different modularity with an additional LINE module, 30 cm long. The structure is in ribbed coloured glass in glossy Caffè finish and with a band below the basin in matt Caffè lacquered finish. The top is in "Tortora elegance" Purefeel with NICK integrated washbasin.

Composizione con un mobile portalavabo e un mobile complementare ad altezza 51 cm. I frontali dei cassetti in pelle liscia P0027 rendono la composizione originale e audace, mentre l'illuminazione è costituita sia dalla lampada LUME sia dalla barra LINE. Frontalmente alla composizione troviamo la vasca VEGA in lightfeel bianco opaco e due vani a giorno OPEN sovrapposti con altezza 120 cm, per quanto riguarda gli arredi, sono presenti il tavolino MEDEA e il pouf KIM.

In alternativa la composizione è disponibile nella versione con differente modularità data dall'aggiunta di un modulo LINE lungo 30 cm, con struttura in vetro cannettato laccato Caffè lucido e fascia sottolavabo in laccato Caffè opaco con top in purefeel colore Tortora elegance completa di vasca integrata NICK.



**Composition ED_015**

Structure:
W 1,2 + 120 + 45 + 1,2 cm
D 52,5 cm
H 50 + 1,2 cm
Matt Caffè lacquered Finish

Band below the basin:
Matt Caffè lacquered Finish

Frontal drawers:
Smooth leather P0027

Top:
Caffè satin lacquered glass with
Rose integrated washbasin
Brushed black

Easy mirror:
W 170 - H 80 cm

Lume lamp:
Black

Line bar and modules:
Brushed black Aluminium with stopsol
glass doors

Vega bathtub:
Matt white Lightfeel

Freestanding bath Stilo mixer:
Brushed black

Open open-shelving wall units:
Matt Caffè lacquered Finish
H 120 cm

_Complements
Medea side table

_Variant
W 0,5 + 120 + 45 + 0,5 cm
D 52,5 cm
H 50 + 1,2 cm

Structure:
Ribbed coloured glass in glossy Caffè
finish

Band below the basin:
Matt Caffè lacquered Finish

Top:
Purefeel in "Tortora elegance" finish
with Nick integrated washbasin

Line bar with suspended units:
W 45 + 30 + 45 cm

Composizione ED_015

Struttura:
W 1,2 + 120 + 45 + 1,2 cm
D 52,5 cm
H 50 + 1,2 cm
Laccato Caffè opaco

Fascia sottolavabo:
Laccato Caffè opaco

Frontali cassetti:
Pelle liscia P0027

Top:
Vetro laccato Caffè satinato con vasca
integrata Rose

**Bocca di erogazione e miscelatore
monocomando Stilo:**
Nero spazzolato

Specchio Easy:
W 170 - H 80 cm

Lampada Lume:
Nero

Barra Line e moduli:
Alluminio nero spazzolato con ante vetro
stopsol

Vasca Vega:
Lightfeel bianco opaco

Colonna miscelatore vasca da terra Stilo:
Nero spazzolato

Vani a giorno Open:
Laccato Caffè opaco
H 120 cm

_Complementi
Tavolino Medea

_Variante
W 0,5 + 120 + 45 + 0,5 cm
D 52,5 cm
H 50 + 1,2 cm

Struttura:
Vetro cannettato laccato Caffè lucido

Fascia sottolavabo:
Laccato Caffè opaco

Top:
Purefeel colore Tortora elegance con
vasca integrata Nick

Barra Line e moduli:
W 45 + 30 + 45 cm

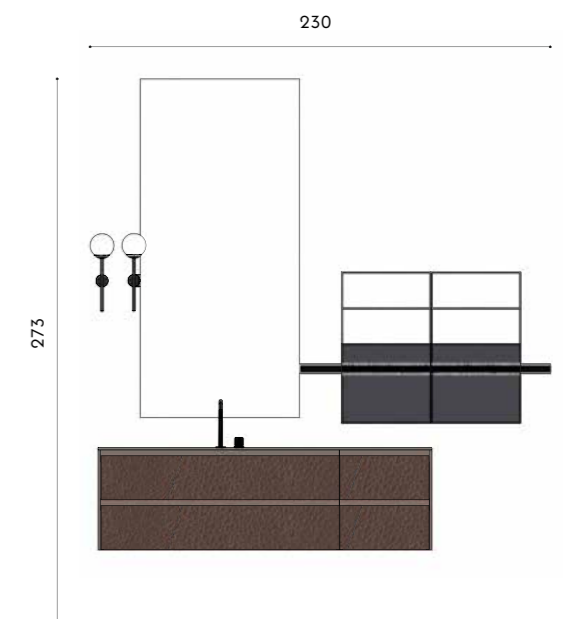

EDEN_016

VERDE SALICE - CORDA ELEGANCE

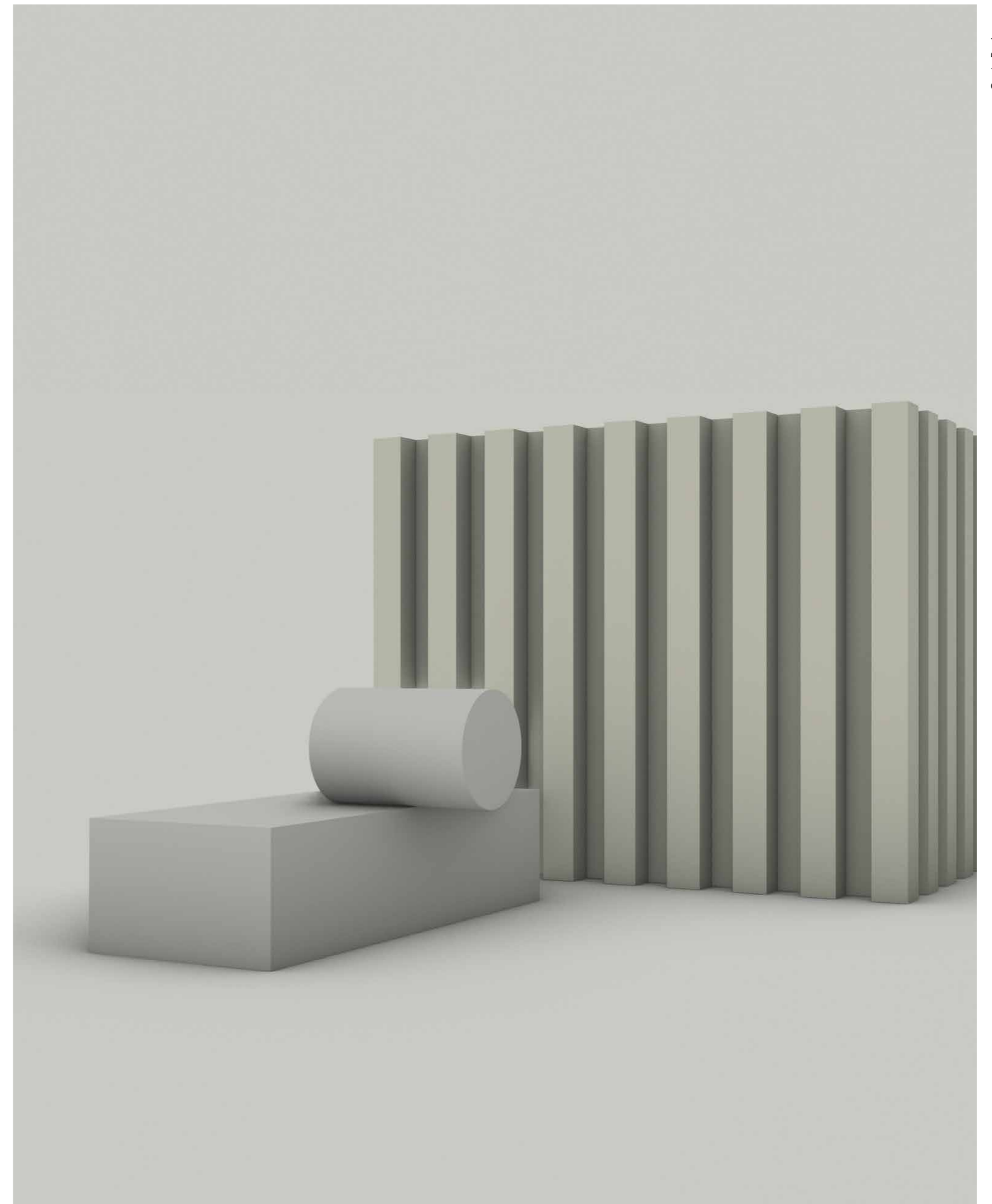





Composition made of a vanity unit, with 1 drawer and 1 inside drawer, an additional base in matt "Verde salice" lacquered finish with a height of 51 cm and a top with EDY integrated washbasin in Purefeel in "Corda elegace" finish. The mirror includes TOOBE lamps with a diameter of 3,8 and a length of 12 cm. Leaning against the PARIS SQUARE mirror there is an open wall unit in smoked glass with the back in matt "Verde salice" lacquered finish with a height of 80 cm. LINE bar together with the accessories, like RIGEL bathtub in matt white Purefeel, complete the arrangement.

The variant is made of a top with DROP integrated washbasin in matt white Lightfeel.

Composizione con un mobile portavabo costituito da un cassetto e un cassetto interno, un mobile complementare ad altezza 51 cm in finitura laccato Verde salice opaco, e un top con vasca integrata EDY in finitura Purefeel colore Corda elegace. Le lampade TOOBE con diametro 3,8 e lunghezza 12 cm sono inserite nello specchio PARIS SQUARE. La composizione è completata da un pensile a giorno in vetro fumè e schiena laccata Verde salice opaco alto 80 cm, il tutto completato dalla barra LINE con accessori. Integrativi all'ambiente sono la vasca in Purefeel bianco opaco RIGEL.

La variante prevede il top con vasca integrata DROP in lightfeel bianco opaco.





**Composition ED_016**

Structure:
 W 1,2 + 120 + 35 + 1,2 cm
 D 52,5 cm
 H 50 + 1,2 cm
 Matt "Verde salice" lacquered Finish

Shelf below the basin:
 Matt "Verde salice" lacquered Finish

Top:
 Purefeel in "Corda elegance" finish with
 Edy integrated washbasin

**Deck mounted single lever basin Stilo
 mixer:**
 Brushed black

Paris Square mirror:
 W 120 cm - H 80 cm

Open-shelving wall units:
 Back in matt "Verde salice" lacquered
 finish, structure and shelf in smoked
 glass finish H 80 cm

Line bar and accessories:
 Brushed black Aluminium

Rigel bathtub:
 Purefeel in matt white

Freestanding bath Stilo mixer:
 Brushed black

_Variante:
 Top in matt white lightfeel with Drop
 integrated washbasin

Composizione ED_016

Struttura:
 W 1,2 + 120 + 35 + 1,2 cm
 D 52,5 cm
 H 50 + 1,2 cm
 Laccato Verde salice opaco

Fascia sottolavabo:
 Laccato Verde salice opaco

Top:
 Purefeel colore Corda elegance con
 vasca integrata Edy

Miscelatore lavabo Stilo:
 Nero spazzolato

Specchio Paris Square:
 W 120 - H 80 cm

Pensile a giorno:
 Fondo Laccato Verde salice opaco,
 struttura e mensola in vetro fumè
 H 80 cm

Barra Line e accessori:
 Alluminio nero spazzolato

Vasca Rigel:
 Purefeel bianco opaco

Colonna miscelatore vasca da terra Stilo:
 Nero spazzolato

_Variante:
 Top in lightfeel bianco opaco con vasca
 integrata Drop

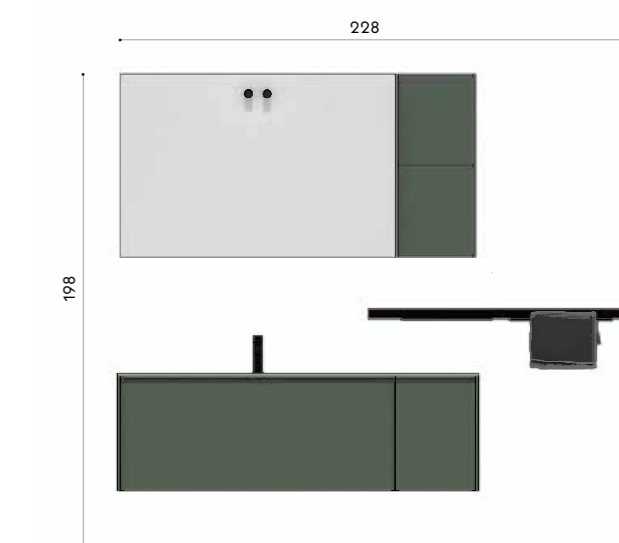

EDEN_017
CHARCOAL OAK - BLACK

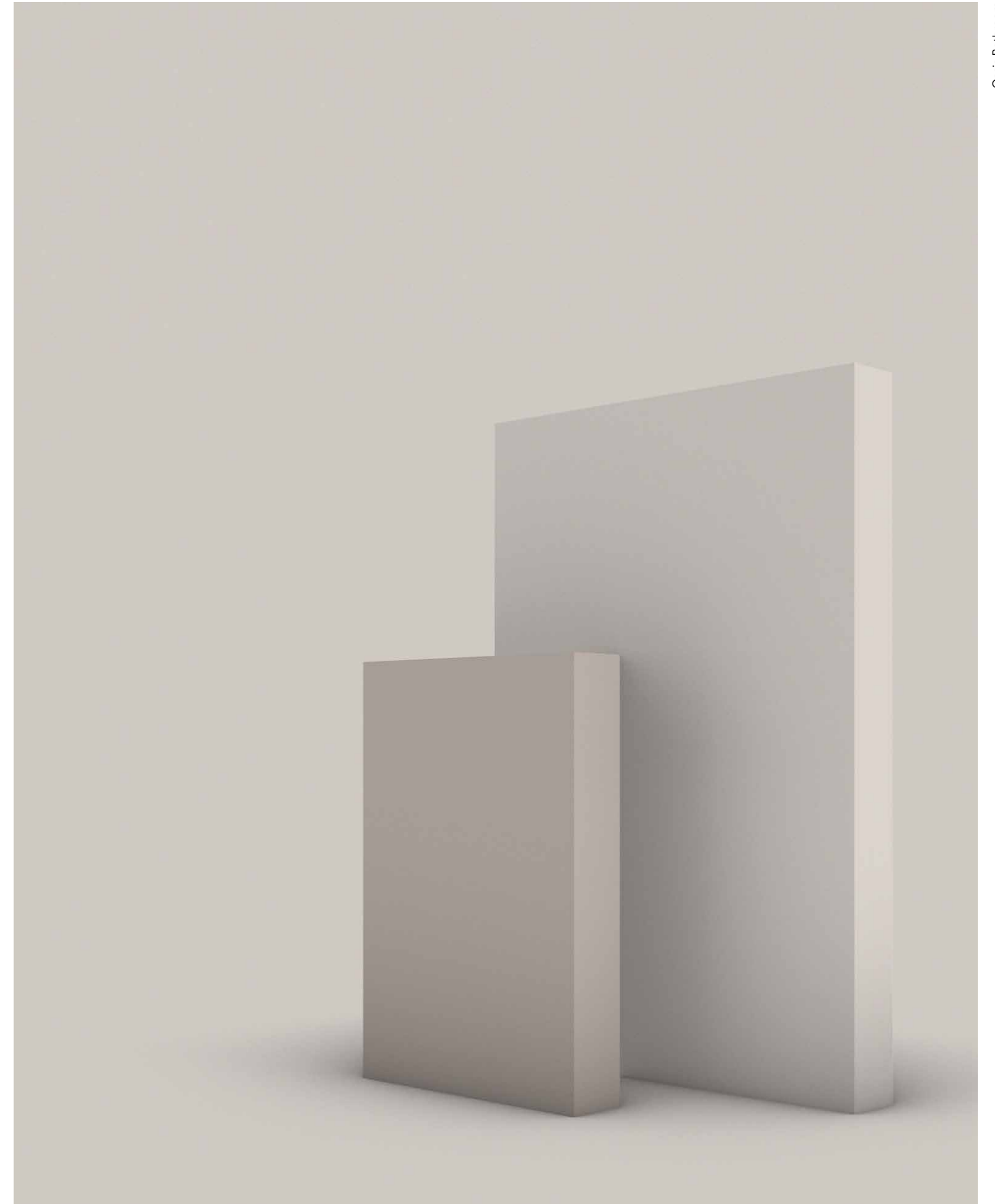





Composition made of a complementary unit with at a height of 31 cm in "Nero Lavagna" lacquered finish and a top in Charcoal Oak finish with VOLCANO countertop basin. The composition develops in height thanks to DALI FULL mirror which is 160 cm high and SEI lamp in burnished finish. Further lighting is given by LINE bar which is 60 cm long. The room is enriched by two OTTO poufs.

Composizione con un mobile complementare ad altezza 31 cm in finitura laccato "Nero Lavagna", e un top portalavabo in Charcoal Oak con lavabo VOLCANO in appoggio. La composizione si sviluppa in altezza grazie allo specchio DALI FULL alto 160 cm e grazie anche alla lampada SEI in finitura brunita, mentre ulteriore illuminazione è data dalla barra LINE lunga 60 cm. L'ambiente è arricchito da una composizione di due pouf OTTO.



**Composition ED_017**

Top with countertop basin:
Charcoal Oak finish L 190 cm H 6 cm
Volcano countertop basin in Black
Lightfeel H 15 cm

Complementary unit:
W 1,2 + 120 + 1,2 cm
D 52,5 cm
H 30 +1,2 cm
"Nero Lavagna" lacquered Finish

Wall mounted Stilo mixer with spout:
Brushed black

Dali Full mirror:
W 60 cm - H 160 cm

Line bar and module:
Brushed black Aluminium

Sei lamp:
Burnish

_Complements
Otto pouf

Composizione ED_017

Top con lavabo in appoggio:
Finitura Charcoal Oak L 190 cm H 6 cm
Lavabo in appoggio Volcano in Lightfeel
nero H 15 cm

Base complementare:
W 1,2 + 120 + 1,2 cm
D 52,5 cm
H 30 +1,2 cm
Finitura laccata "Nero Lavagna"

Miscelatore a parete con bocca di
erogazione Stilo:
Nero spazzolato

Specchio Dali Full:
W 60 - H 160 cm

Barra Line e modulo:
Alluminio nero spazzolato

Lampada Sei:
Brunito

_Complements
Pouf Otto

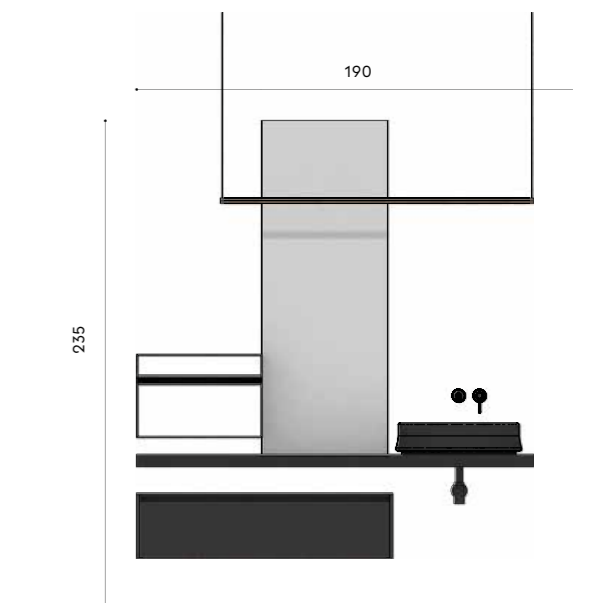

EDEN_018

FENIX NTM® CASTORO - CAFFÈ

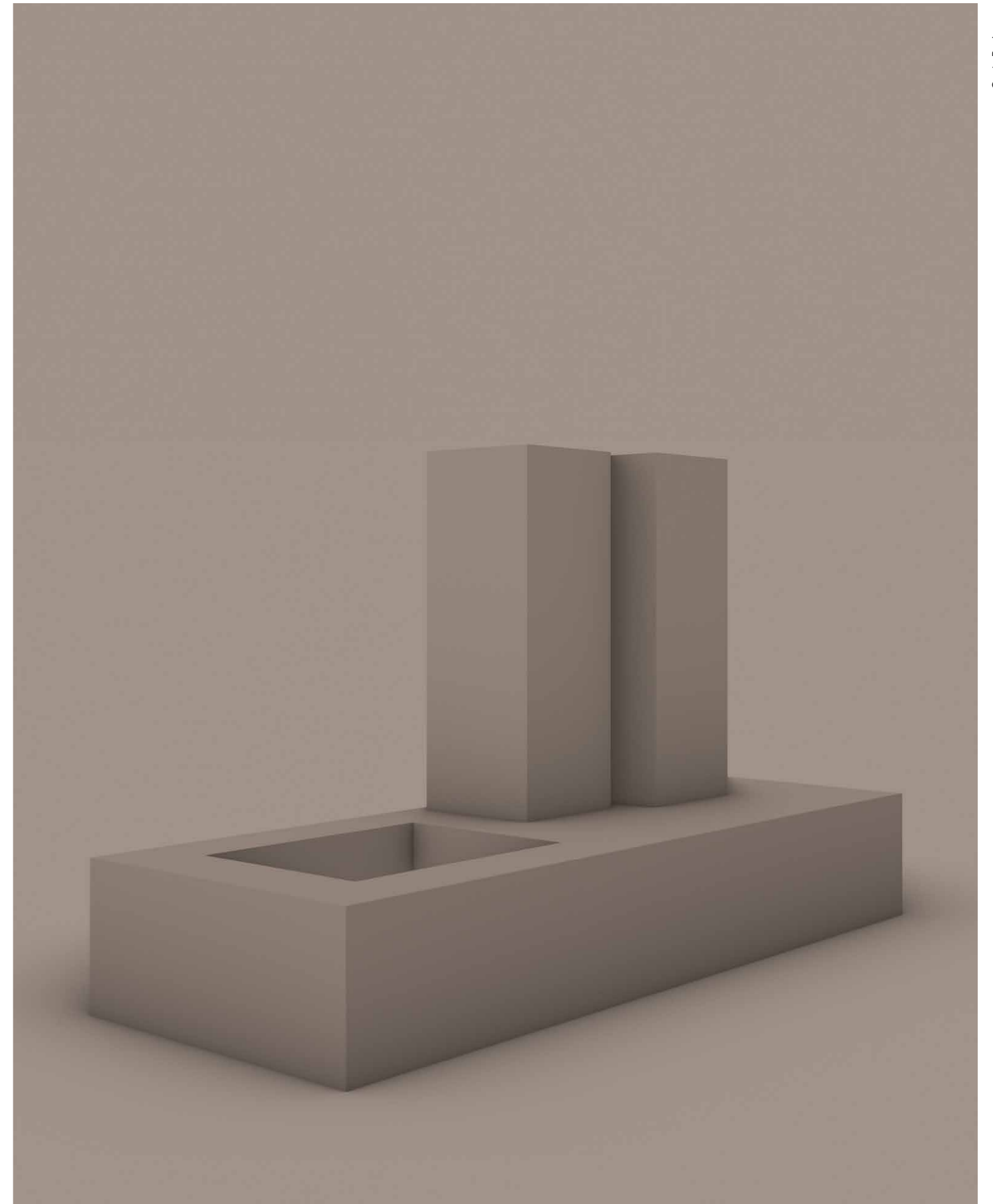





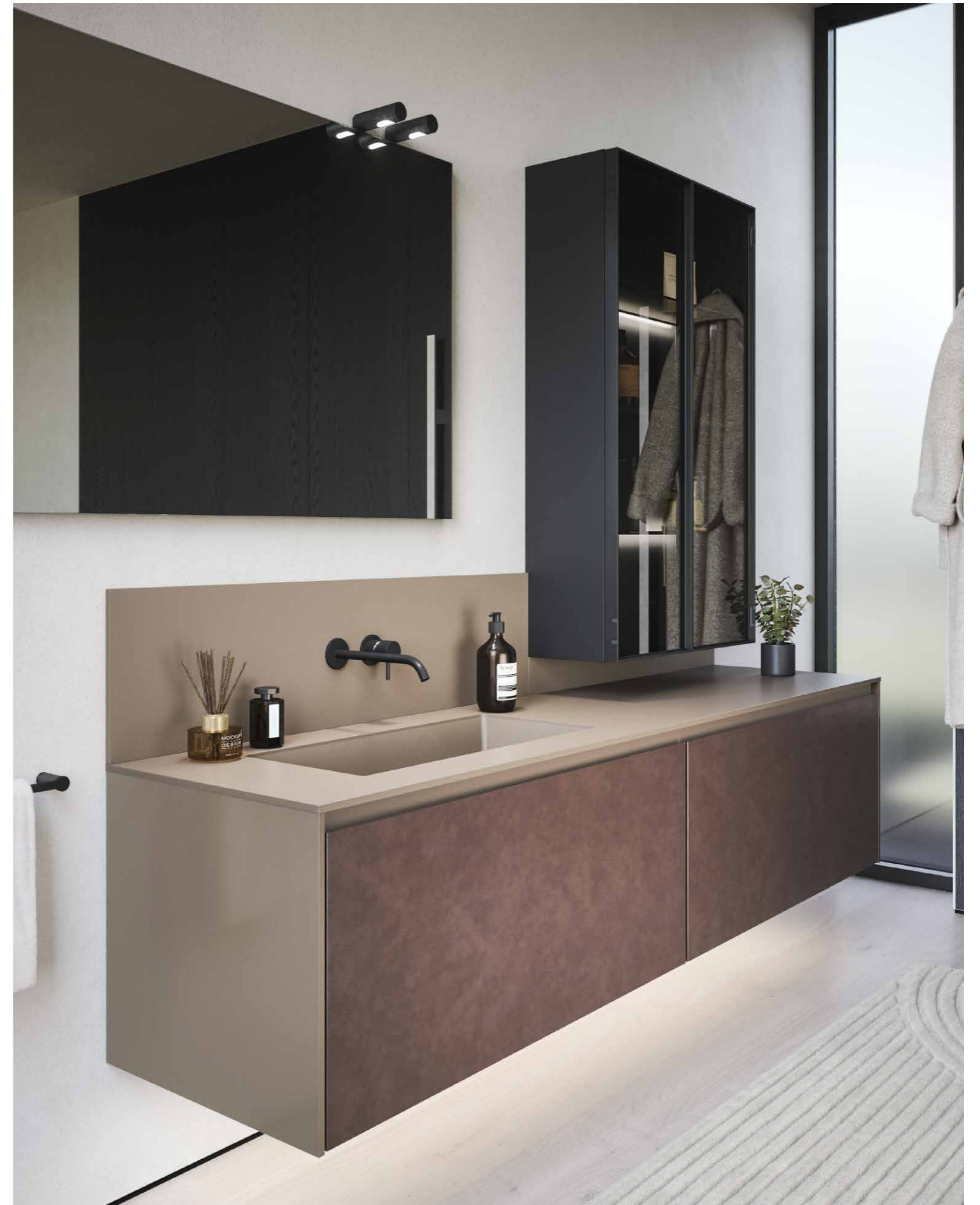

Composition made of a vanity unit and an additional base at a height of 51 cm. Top with Hanna integrated washbasin in Castoro Fenix finish and frontal drawers in smooth leather P0027. Additional storage space is given by the 120 cm high ALU tall unit with glass doors, while the lighting is given by the black TOOBE lamps with a diameter of 3,8 cm fixed on the EASY mirror of dimensions W 170 – H 80 cm. Integrative element of the composition is the MUFFIN pouf.

The variant is available in Corda elegance lacquered finish with a Corda elegance color purefeel top with NICK integrated washbasin and frontal drawers in lacquered Antracite Dark.

Composizione con un mobile portavaso e uno complementare ad altezza 51 cm, con top e vasca integrata Hanna in Fenix Castoro e frontali dei cassetti in pelle liscia P0027. Ulteriore spazio contenitivo è dato dalla colonna con ante a vetro ALU alta 120 cm, mentre l'illuminazione è fornita dalle lampade nere TOOBE con diametro 3,8 cm con fissaggio sullo specchio EASY di dimensioni W 170 – H 80 cm. Elemento integrativo della composizione è il pouf MUFFIN.

La variante è disponibile in struttura Laccato Corda elegance con top in purefeel colore Corda elegance con vasca integrata NICK e frontali Laccato Antracite Dark.



**Composition ED_018**

Structure:
W 1,2 + 105 + 105 + 1,2 cm
D 52,5 cm
H 50 + 1,2 + 30 cm
Lacquered and Castoro Fenix finish

Frontal drawers:
Smooth leather P0027

Band below the basin:
Matt Caffè lacquered Finish

Top:
Castoro Fenix finish with Nix integrated washbasin

Wall mounted Stilo mixer with spout:
Brushed black

Easy mirror:
W 170 - H 80 cm

Toobe Lamp:
"Nero Lavagna"
Ø 3,8 - D 12 cm

Alu tall unit with LED integrated lighting behind the shelves:
Panel in Brushed black Aluminium with smoked glass doors
H 120 cm

_Variant
Structure:
"Corda elegance" lacquered finish

Frontal drawers:
Lacquered Antracite Dark

Top:
Purefeel in "Corda Elegance" with Nick integrated washbasin

Composizione ED_018

Struttura:
W 1,2 + 105 + 105 + 1,2 cm
D 52,5 cm
H 50 + 1,2 + 30 cm
Laccato e Fenix Castoro

Frontali cassetti:
Pelle liscia P0027

Fascia sottolavabo:
Laccato Caffè opaco

Top:
Fenix Castoro con vasca integrata Nix

Miscelatore a parete con bocca di erogazione Stilo:
Nero spazzolato

Specchio Easy:
W 170 - H 80 cm

Lampade Toobe:
Finitura "Nero Lavagna"
Ø 3,8 - D 12 cm

Colonna Alu con luce led integrata dietro i ripiani:
Telaio in alluminio nero spazzolato con ante in vetro fumè
H 120 cm

_Variante
Struttura:
Laccato Corda elegance

Frontali cassetti:
Laccato Antracite Dark

Top:
Purefeel colore Corda elegance con vasca integrata Nick



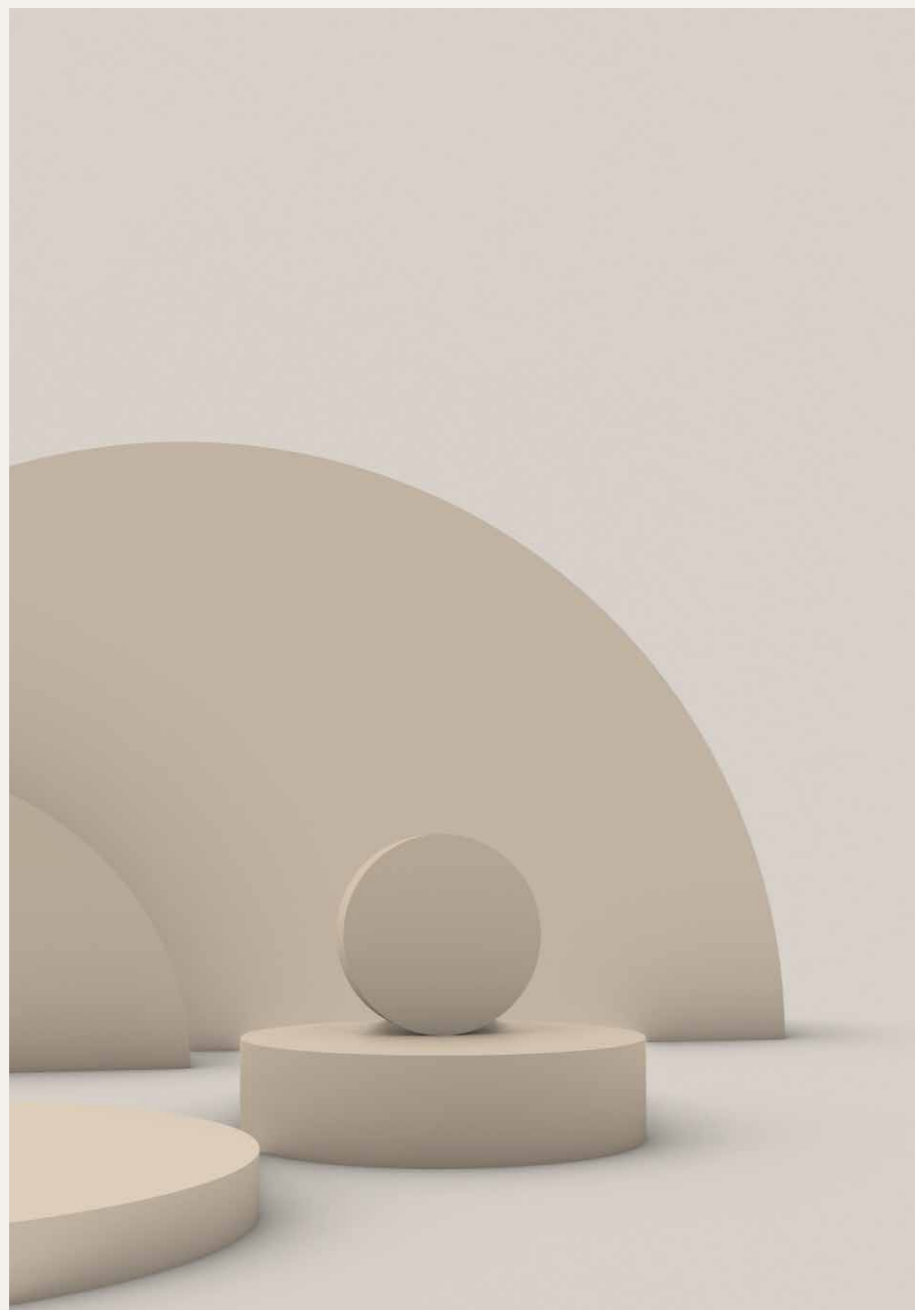

Technical Data and Finishes

Each collection is unique, with its own technical characteristics and modularity. Each collection comes with a wide range of products, sizes and materials. All products are completely Made in Italy with high quality standards.

Ogni collezione è unica, con caratteristiche tecniche e modularità proprie. Ogni collezione viene fornita con una vasta gamma di prodotti, dimensioni e materiali. Tutti i prodotti sono completamente Made in Italy con elevati standard qualitativi.

EDEN Technical Data

Eden Caratteristiche tecniche



For porcelain stone units the vein continues from the side panels to the fronts
Continuità della venatura tra frontali e fianchi nei mobili in gres

New leather finishing
Nuove finiture in pelle

EDEN Technical Data

Eden Caratteristiche tecniche



Ribbed coloured glass
Vetro colorato cannettato

Eden Collection always includes the side panels
La collezione Eden prevede sempre i fianchi di finitura

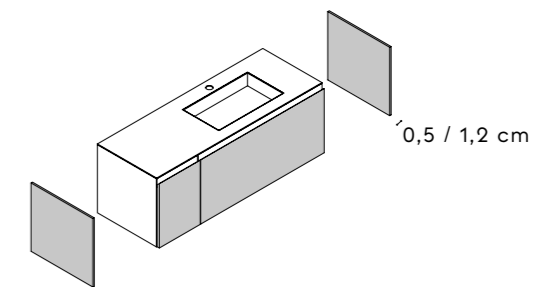

MODULARITY

Modularità

WALL MOUNTED ELEMENTS / MOBILI SOSPESI - H 30 CM

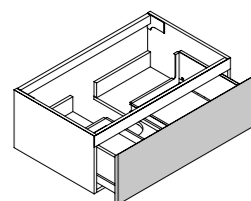

Wall mounted vanity unit
with 1 drawer
Base portlavabo sospesa
con 1 cassetto
W 60/70/80/90/105/120 cm
D 52,5 cm

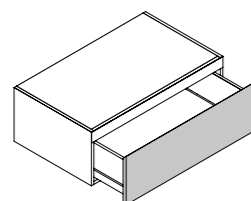

Additional wall-hung base unit
with 1 drawer
Base complementare sospesa
con 1 cassetto
W 35/45/60/70/80/90/105/120 cm
D 52,5 cm

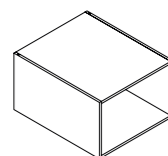

Additional wall-hung base unit
with open shelf
Base complementare sospesa
con vano a giorno
W 35/45 cm
D 52,5 cm

WALL MOUNTED ELEMENTS / MOBILI SOSPESI - H 50 CM

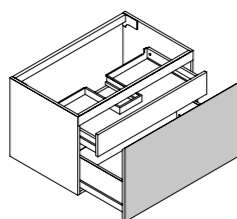

Wall mounted vanity unit
with 1 drawer + inside drawer
Base portlavabo sospesa con 1
cassetto + cassetto interno
W 60/70/80/90/105/120 cm
D 52,5 cm

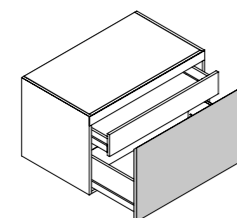

Additional wall-hung base unit
with 1 drawer + 1 inside drawer
Base complementare sospesa
con 1 cassetto + 1 cassetto
interno
W 35/45/60/70/80/90/105/120 cm
D 52,5 cm

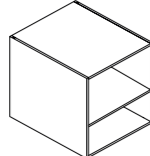

Additional wall-hung base unit
with open shelf
Base complementare sospesa
con vano a giorno
W 35/45 cm
D 52,5 cm

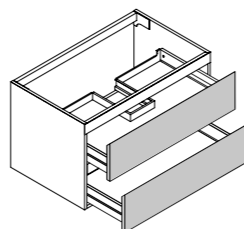

Wall mounted vanity unit with 2
drawers
Base portlavabo sospesa con 2
cassetti
W 60/70/80/90/105/120 cm
D 52,5 cm

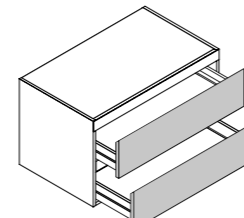

Additional wall-hung base unit
with 2 drawers
Base complementare sospesa
con 2 cassetti
W 35/45/60/70/80/90/105/120 cm
D 52,5 cm

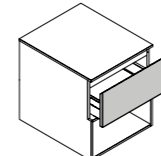

Additional wall-hung base unit with
1 drawer and open shelf
Base complementare sospesa con 1
cassetto e vano a giorno
W 35/45 cm
D 52,5 cm

MODULARITY

Modularità

FREE STANDING ELEMENTS / MOBILI A TERRA - H 76 CM - TOP 12 CM

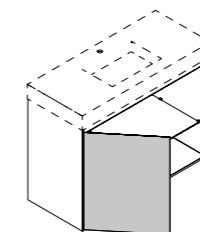

Free standing vanity unit
with 2 doors
Mobile portlavabo a terra
con 2 ante
W 90/120
D 52,5 cm

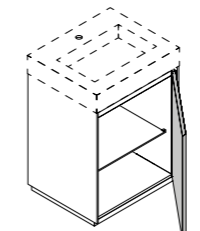

Free standing vanity unit
with 1 door
Mobile portlavabo a
terra con 1 anta
W 60
D 52,5 cm

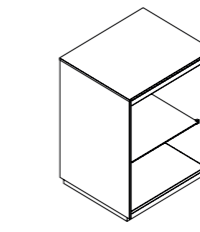

Additional free standing
base unit with 1 door
Mobile complementare a
terra con 1 anta
W 35/45/60 cm
D 52,5 cm

FREE STANDING ELEMENTS / MOBILI A TERRA - H 86 CM - TOP 1,2/2 CM

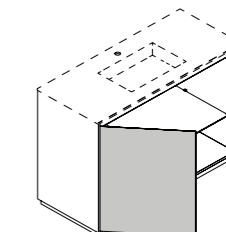

Free standing vanity unit
with 2 doors
Mobile portlavabo a
terra con 2 ante
W 90/120
D 52,5 cm

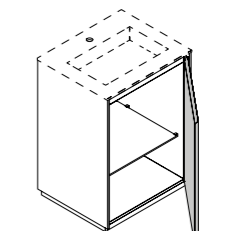

Free standing vanity unit
with 1 door
Mobile portlavabo a
terra con 1 anta
W 60
D 52,5 cm

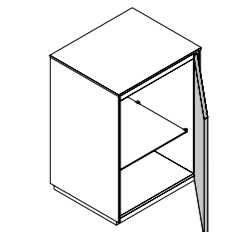

Additional free standing
base unit with 1 door
Mobile complementare a
terra con 1 anta
W 35/45/60 cm
D 52,5 cm

ALL THE INDICATED DIMENSIONS DO NOT INCLUDE THE FINISHING SIDE PANELS WHICH MUST BE ADDED
TUTTE LE MISURE INDICATE NON INCLUDONO I FIANCHI DI FINITURA CHE DOVRANNO ESSERE AGGIUNTI

MODULARITY

Modularità

"CUBE" WALL-HUNG TALL UNITS WITH PUSH-PULL OPENING SYSTEM / COLONNE "CUBE" CON SISTEMA DI APERTURA PUSH-PULL - H 80/120/162 /196* CM

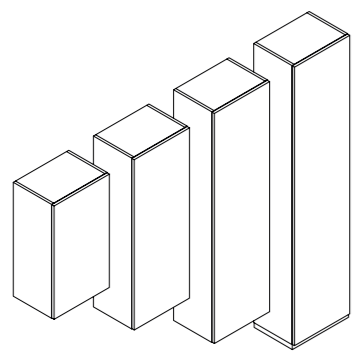

Wall-hung tall units
Colonne sospese

W 35/45/70/90 cm
D 25/35 cm

"CUBE" WALL- HUNG TALL UNITS WITH HANDLE / COLONNE "CUBE" CON MANIGLIA - H 80/120/162 /196* CM

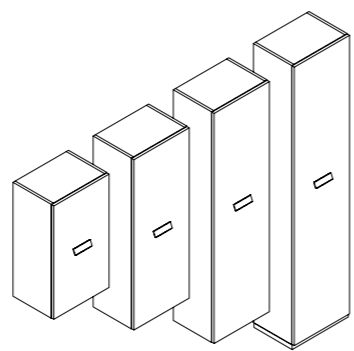

Wall-hung tall units
Colonne sospese

W 35/45/70/90 cm
D 25/35 cm



MAURÌ



HOLY

HANDLES / MANIGLIE

Available in 2 finishes: black or bronze / Disponibili in 2 finiture: nero e bronzo

"ALU" WALL-HUNG TALL UNITS WITH DOORS IN BLACK ALUMINIUM FRAME / COLONNE "ALU" CON ANTA TELAIO IN ALLUMINIO NERO - H 80/120/162 /196* CM

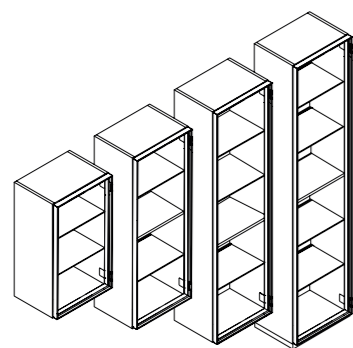

Wall-hung tall units
Colonne sospese

W 35/45/70/90 cm
D 25/35 cm

"MAX " WALL-HUNG TALL UNITS WITH CANTILEVER DOOR / COLONNE "MAX" CON ANTA A SBALZO - H 80/120/162 /196* CM

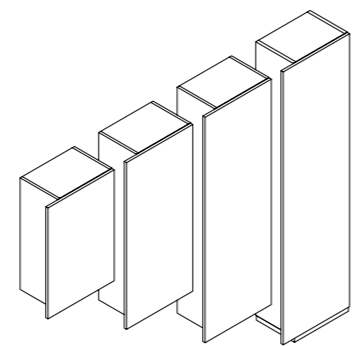

Wall-hung tall units
Colonne sospese

W 45 cm
D 25/35 cm

MODULARITY

Modularità

EDEN WALL-HUNG TALL UNITS / COLONNE SOSPESSE EDEN - H 162 CM

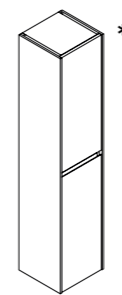

Wall-hung tall units
Colonne sospese

W 32 cm
D 32 cm

"OPEN" WALL-HUNG TALL UNITS WITH OPEN SHELVES / COLONNE SOSPESSE CON VANO A GIORNO "OPEN" - H 80/120/162 /196* CM

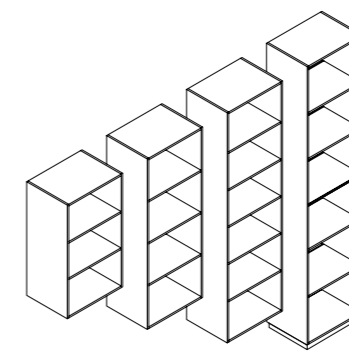

Wall-hung tall units
Colonne sospese con vano a giorno

W 35/45 cm
D 25/35 cm

BOISERIE CUSTOM MADE "RIGA" / BOISERIE "RIGA" SU MISURA

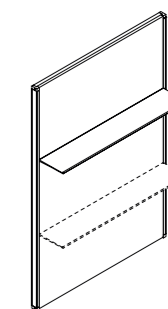

Boiserie custom made
Boiserie su misura

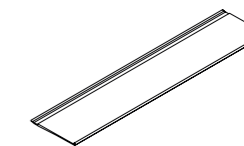

Shelf
Mensole
W 30/60/75/90/120

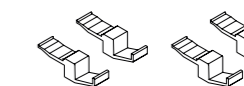

4 hooks set
Set 4 ganci

WALL UNIT / PENSILI - H 80 CM

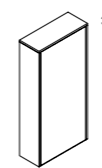

Wall unit with 1 door
Pensile 1 anta

W35 X D15 cm

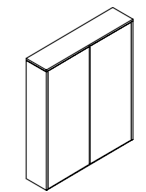

Wall units 2 doors
Pensile 2 ante

W70 X D15 cm

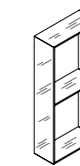

Open-shelving wall unit in smoked glass
Pensile a giorno in vetro fumè

W35 X D15 cm



Open-shelving wall unit in smoked glass
Pensile a giorno in vetro fumè

W50 X D15 cm

FLOOR-STANDING TALL UNITS H 196 CM WITH PLINTH
LE COLONNE A TERRA CON ALTEZZA 196 CM SONO COMPLETE DI ZOCCOLO
*WITH LENGTH 70/90 CM, TALL UNITS ARE PROVIDED WITH 2 DOORS
*NELLA LUNGHEZZA 70/90 CM COLONNA DOTATA DI DUE ANTE

FLOOR-STANDING TALL UNITS H 196 CM WITH PLINTH
LE COLONNE A TERRA CON ALTEZZA 196 CM SONO COMPLETE DI ZOCCOLO
*ALL THE INDICATED DIMENSIONS DO NOT INCLUDE THE FINISHING SIDE PANELS WHICH MUST BE ADDED
*TUTTE LE MISURE INDICATE NON INCLUDONO I FIANCHI DI FINITURA CHE DOVRANNO ESSERE AGGIUNTI

LINE accessories collections

Accessori LINE

APPLICATION EXAMPLES / ESEMPI DI APPLICAZIONE

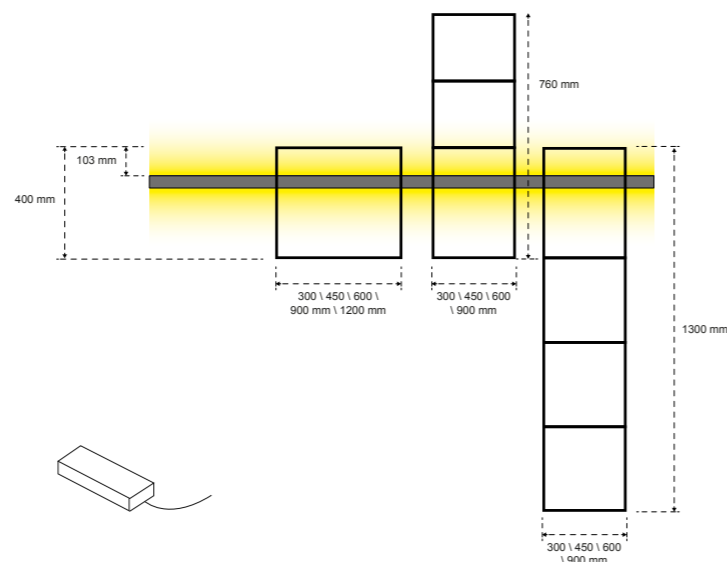

Light bar equipped with power supply to be positioned on the back of the mirrors or inside the element with plug and USB.

Barra luminosa fornita di alimentatore da posizionare sul retro delle specchiere o all'interno dell'elemento con presa elettrica e USB.

ACCESSORIES / ACCESSORI

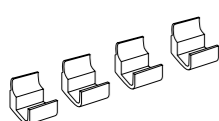

4 hooks set
Set 4 ganci
W 2 X H 2,5 X D 3,4 cm

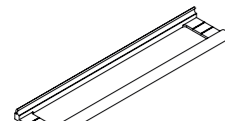

Towel rail
Portasalviette
W 45 X H 2,5 X D 9 cm



Shelf
Mensola
W 28,6/39/43,6/58,6/88,6 cm
H 2,4 X D 13 cm

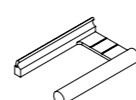

Paper roll holder
Porta rotolo
W 14 X H 2,5 X D 9 cm

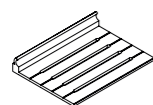

Soap holder
Porta sapone
W 15 X H 2,5 X D 11 cm

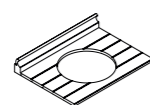

Tumbler holder
Porta bicchieri
W 15 X H 2,5 X D 11 cm

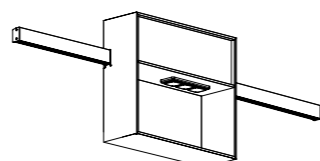

Box with electric socket and USB
Elemento con presa elettrica e USB
W 45 X H 40 X D 15 cm

2 SCHUKO
2 USB

LINE accessories collections

Accessori LINE

HORIZONTAL AND VERTICAL MODULES / MODULI ORIZZONTALI E VERTICALI

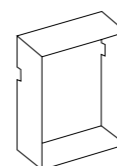

Wall unit with open compartment
Pensile con vano a giorno

W 30/45/60 cm
H 40
D 15 cm

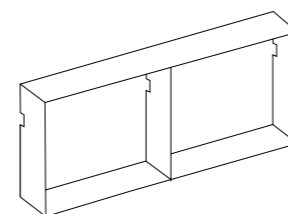

Wall unit with 2 open compartments
Pensile con 2 vani a giorno

W 90
H 40 cm
D 15 cm

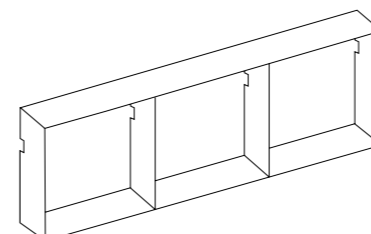

Wall unit with 3 open compartments
Pensile con 3 vani a giorno

W 120
H 40 cm
D 15 cm

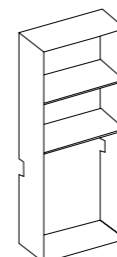

Vertical wall unit with 3 open compartments
Pensile verticale con 3 vani a giorno

W 30/45/60/90 cm
H 76 cm
D 15 cm

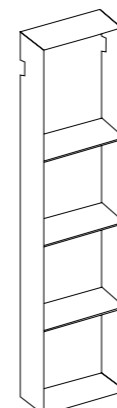

Vertical wall unit with 4 open compartments
Pensile verticale con 4 vani a giorno

W 30/45/60/90 cm
H 130
D 15 cm

MODULES WITH GLASS DOOR "STOP SOL" / MODULI CON ANTE IN VETRO "STOP SOL"

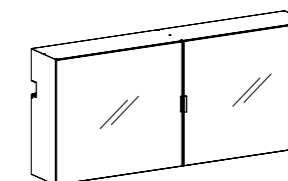

Wall unit with 2 glass doors
Pensile con 2 ante a vetro

W 90 cm
H 40
D 15 cm

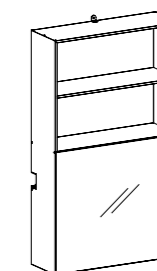

Wall unit with 1 glass door and 2 open compartments
Pensile con 1 anta a vetro e 2 vani a giorno

W 45 cm
H 76
D 15 cm

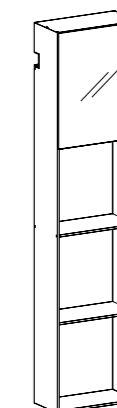

Vertical wall unit with 1 glass door and 3 open compartments
Pensile verticale con 1 anta a vetro e 3 vani a giorno

W 30 cm
H 130
D 15 cm

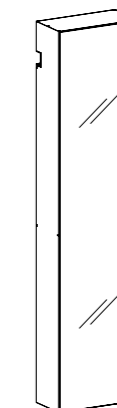

Vertical wall unit with 1 glass door
Pensile verticale con 1 anta a vetro

W 30 cm
H 130
D 15 cm

BASIN TYPES FOR TOPS WITH INTEGRATED BASINS

Tipologie di lavabi per top con vasche integrate

MATT WHITE PUREFEEL - GLOSSY WHITE GEACRIL / PUREFEEL BIANCO OPACO -
GEACRIL BIANCO LUCIDO - TOP H 1,2/ 12 CM



NICK
NICK 1 - W 50 X D 31 cm
NICK 2 - W 60 X D 31 cm



EDY
EDY 1 - W 50 X D 31,5 cm
EDY 2 - W 58,6 X D 31,5 cm



CUT
CUT 1 - W 48 X D 31 cm
CUT 2 - W 58 X D 31 cm



COLOURED GLASS / VETRO
COLORATO TOP H 1,2 CM



ROSE
ROSE 1 - W 51 X D 33 cm
ROSE 2 - W 77 X D 33 cm



MATT WHITE LIGHTFEEL / LIGHTFEEL BIANCO OPACO -
TOP H 1,2/ 12 CM



DROP
W 72 X D 31 cm



CIRCLE
Ø 42cm



PAUL
PAUL 1 - W 50 X D 31,5 cm
PAUL 2 - W 60 X D 31,5 cm



HARRY
HARRY 1 - W 59 X D 34 cm
HARRY 2 - W 68 X D 38 cm

FENIX NTM®
TOP H 1,2/ 12 CM



HANNA
HANNA 1 - W 48 X D 30 cm
HANNA 2 - W 68 X D 30 cm
Available with upper removable panel
Disponibile con elemento superiore
amovibile

PORCELAIN STONE / GRES
PORCELLANATO TOP H 1,2/ 12 CM



ROCK
ROCK 1 - W 47 X D 29 cm
ROCK 2 - W 59 X D 29 cm

CERAMIC / CERAMICA -
UNDERCOUNTER WASBASIN /
LAVABO AD INCASSO SOTTOPIANO



KIM
To be combined with marble tops
Da abbinare ai piani in marmo
KIM 1 - W 56 X D 37 cm
KIM 2 - W 71 X D 37 cm

COUNTERTOP WASHBASINS SELECTION

Selezione lavabi da appoggio

MATT WHITE CERAMIC / CERAMICA BIANCO OPACO



AURORA
Ø 40 cm X H 20 cm



SARAH
W 60 X D 36 X H 12 cm

GLOSSY WHITE CERAMIC / CERAMICA BIANCO LUCIDO



AMY
W 55 X D 42 X H 13 cm



LISA
W 60 X D 42 X H 14 cm

MATT WHITE PUREFEEL / PUREFEEL BIANCO OPACO



MARY
W 52,5 X D 33,5 X H 14 cm



JULIA
Ø 42 X H 14 cm

MATT WHITE LIGHTFEEL / LIGHTFEEL BIANCO OPACO



LEAF
W45 x D45 x H12 CM



VOLCANO
W 54,5 X D 40 x H 15

AVAILABLE IN ALL THE MATT
FINISHES FROM THE OASIS COLOR
SAMPLES / DISPONIBILE IN TUTTE LE
FINITURE OPACHE DELLA MAZZETTA
COLORI OASIS

BATHTUBS Collection

Vasche da bagno



ALL BATHTUBS ARE AVAILABLE WITH MATT COLORED FINISH FROM THE OASIS COLOR SAMPLES /
TUTTE LE VASCHE DA BAGNO SONO DISPONIBILI IN FINITURA COLORATA OPACA DELLA MAZZETTA COLORI OASIS

MATT WHITE PUREFEEL / PUREFEEL BIANCO OPACO



HAMAL
W 160 X D 80 X H 55 cm



RIGEL
W 170 X D 70 X H 55 cm

MATT WHITE LIGHTFEEL / LIGHTFEEL BIANCO OPACO



HYDRA
W 175 X D 75 X H 52 cm



VEGA
W 158 X D 77 X H 59 cm



SIRIO
W 170 X D 80 X H 50 cm



MIZAR
W 180 X D 75 X H 50 cm



VOLCANO
W 186 X D 96 X H 50 cm

SYDNEY SANITARY WARE Collection

Sanitari SIDNEY

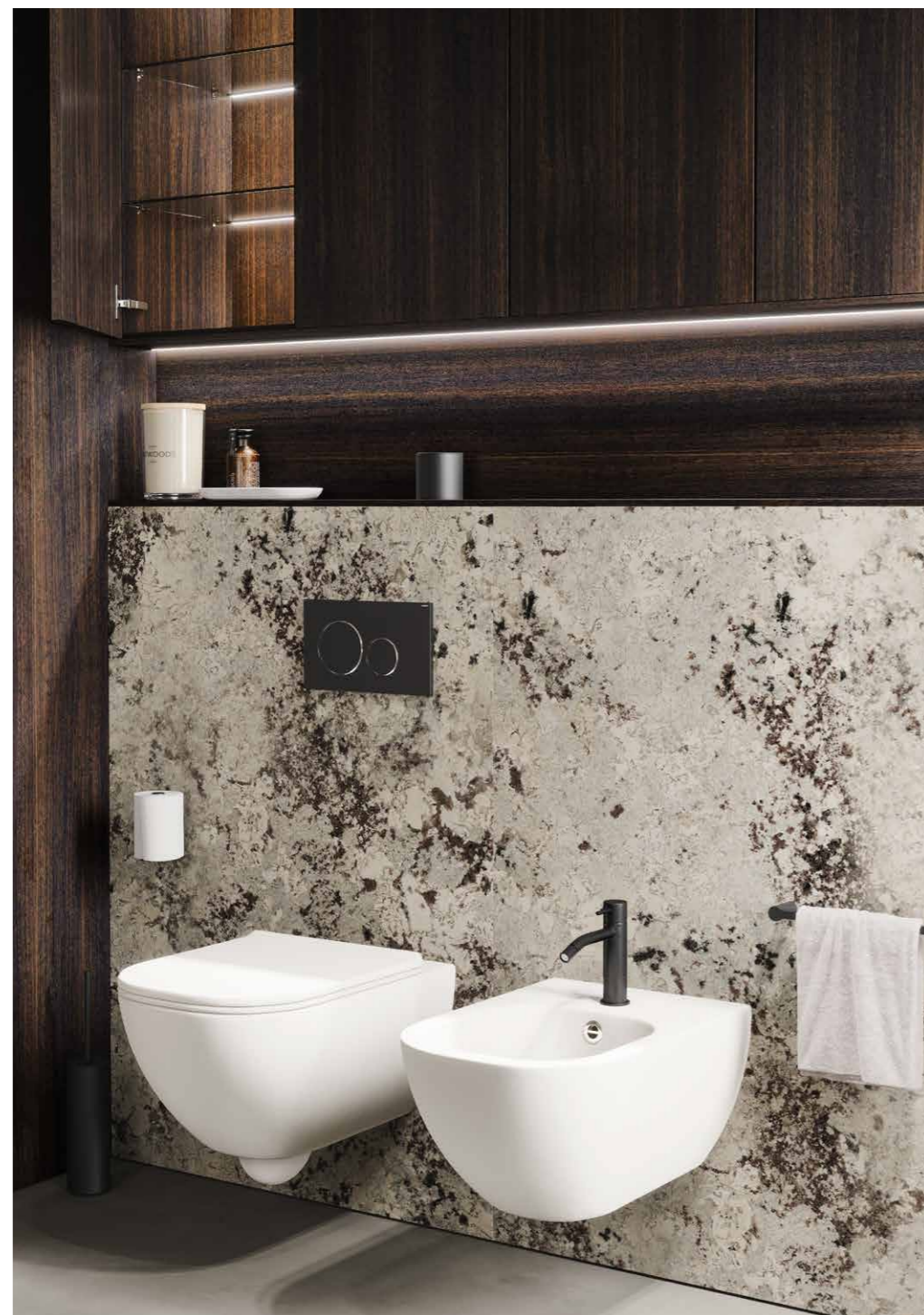

SIDNEY wall-hung version - CERAMIC
 SIDNEY versione sospesa in CERAMICA



WC
 W 37 X D 55 X H 35,5 cm



BIDET
 W 37 X D 55 X H 35,5 cm

SIDNEY back-to-wall version - CERAMIC
 SIDNEY versione a terra in CERAMICA



WC
 W 37 X D 55 X H 41 cm



BIDET
 W 37 X D 55 X H 41 cm

*AVAILABLE IN GLOSSY AND MATT WHITE CERAMIC
 *DISPONIBILE IN CERAMICA BIANCA LUCIDA E OPACA

STILO taps Collection

Rubineria STILO

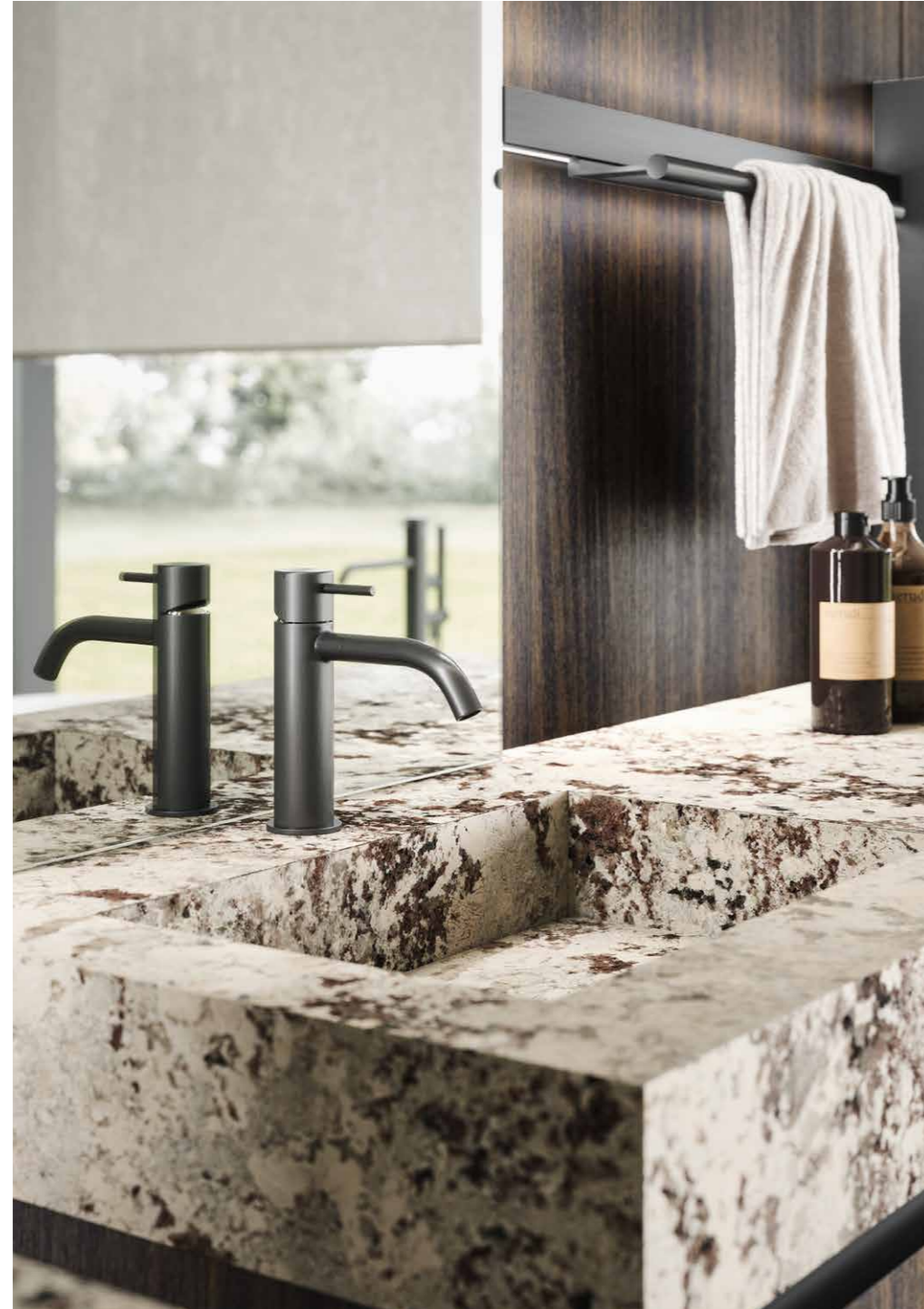

STILO TAPS COLLECTION / RUBINETTERIA STILO

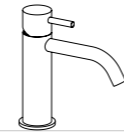

Deck mounted single lever basin mixer H 165 mm
Miscelatore per lavabo H 165 mm

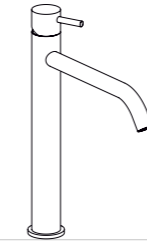

Deck mounted single lever basin mixer H 350 mm
Miscelatore per lavabo da appoggio H 350 mm

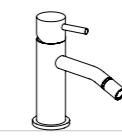

Deck mounted bidet mixer with adjustable spout
Miscelatore per bidet con bocca di erogazione orientabile



Deck mounted single lever basin mixer
Miscelatore monocomando per lavabo da appoggio

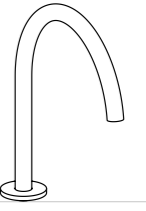

Deck mounted spout H 244 mm
Bocca di erogazione H 244 mm

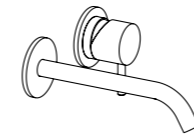

Wall mounted mixer with spout P 160 mm
Miscelatore a parete con bocca di erogazione P 160 mm

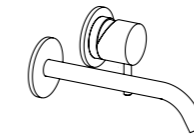

Wall mounted mixer with spout P 200 mm
Miscelatore a parete con bocca di erogazione P 200 mm

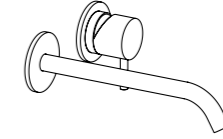

Wall mounted mixer with spout P 250 mm
Miscelatore a parete con bocca di erogazione P 250 mm

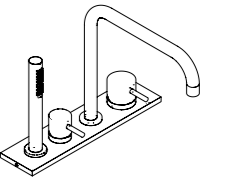

Rim mounted set of 2 mixers with spout and hand shower
Gruppo di 2 miscelatori bordo vasca con bocca di erogazione e doccia

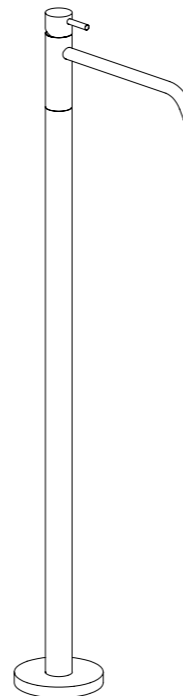

Freestanding single lever mixer for washbasin
Miscelatore lavabo da terra

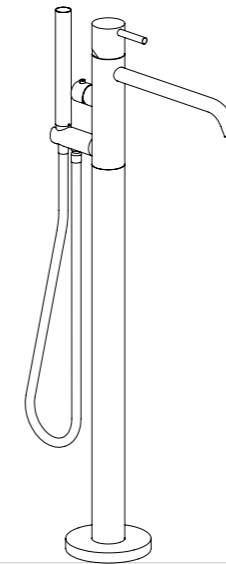

Freestanding bath mixer
Miscelatore vasca da terra

AVAILABLE FINISHES/FINITURE DISPONIBILI



Glossy steel / acciaio lucido



Brushed Steel / acciaio spazzolato



Brushed Black / nero spazzolato



Brushed Gold / oro spazzolato

MIRRORS Collection

Specchiere



EASY
Mirror with aluminum finish frame
Specchio con telaio in finitura alluminio
W 60/70/80/90/105/120/140/160/180 X H 80 cm

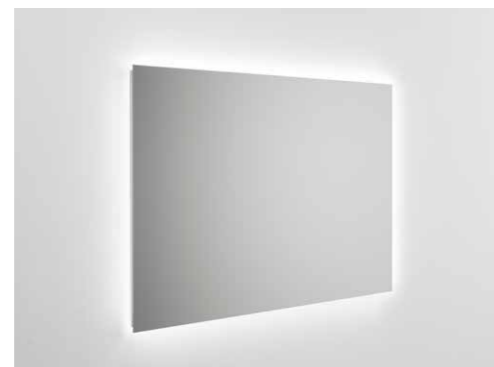

DALI' FULL
Polished edge mirror complete with LED lighting on 4 sides. Without switch.
Specchio a filo lucido completo di illuminazione led sui 4 lati. Senza interruttore.
W from 60 to 210 X H 60/80/105 cm

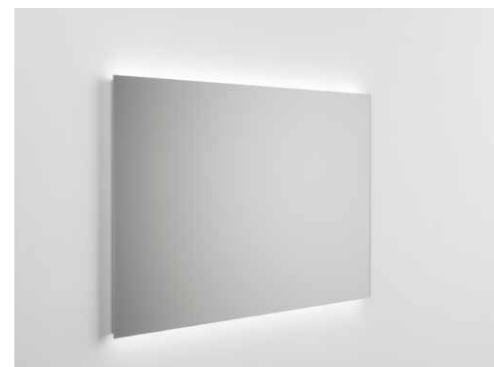

DALI' UP & DOWN
Polished edge mirror complete with upper and lower LED lighting. Without switch.
Specchio a filo lucido completo di illuminazione led superiore ed inferiore. Senza interruttore.
W from 60 to 210 X H 60/80/105 cm



MIRO'
Mirror with aluminum frame in matt white or black finish. Complete with LED lighting in the upper part and touch switch.
Specchio con telaio in alluminio in finiture bianco o nero opaco. Completo di illuminazione led nella parte superiore ed interruttore touch.
W 70/80/90/105/120/140/160 X H 80 cm



FREUD
Mirror with LED backlighting and touch switch with on/off dimmer function
Specchio con retro illuminazione a Led ed interruttore touch con funzione on /off dimmer
W 50 X H 100 cm



HUGO
Oval mirror with LED backlighting and touch switch with on / off dimmer function
Specchio ovale con retroilluminazione a led completo di interruttore a sfioramento con funzione on / off dimmer
W 50 X H 110 cm



JUNG
Mirror with LED backlighting and touch switch with on/off dimmer function
Specchio con retro illuminazione a Led ed interruttore touch con funzione on /off dimmer
W 80 X H 80 cm



ROMA
Mirror with external panel and perimeter in smoked mirror. Complete with LED backlighting and touch switch.
Specchio con pannello esterno e perimetro in specchio fumé. Completo di retro illuminazione a Led ed interruttore touch.
W 90X90 / 105X105 CM

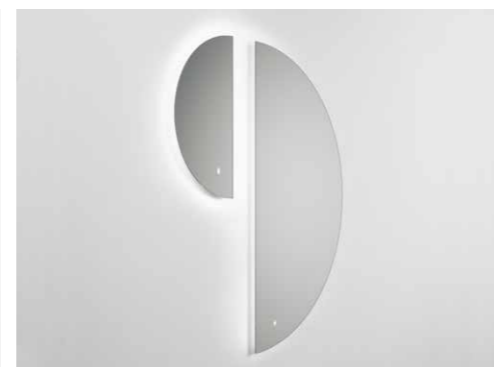

KANT
Mirror with LED backlighting and touch switch with on/off dimmer function
Specchio con retro illuminazione a Led ed interruttore touch con funzione on /off dimmer
W 40 X H 80 cm / W 80 X H 160 cm

MIRRORS Collection

Specchiere

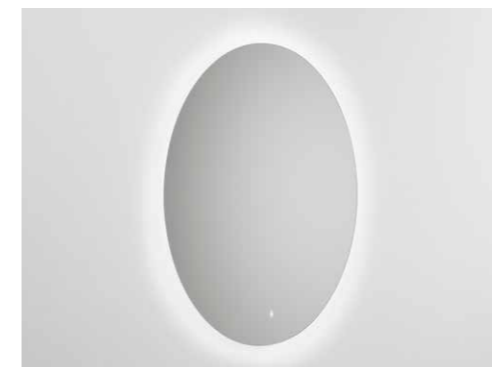

JOYCE
Mirror with LED backlighting and touch switch with on/off dimmer function
Specchio con retro illuminazione a Led ed interruttore touch con funzione on /off dimmer
Ø 80 / Ø 120 cm



DENIS
Mirror with matt white aluminum frame with LED backlighting. Complete with touch switch with on / off dimmer function and warm / cold light regulator.
Specchio con telaio in alluminio bianco opaco con retro illuminazione a Led . Completo di interruttore touch con funzione on /off dimmer e regolatore di luce calda /fredda.
Ø 71,2 / Ø 91,2 cm



DREAM
Mirror with black aluminum frame with LED backlighting. Without switch.
Specchio con telaio in alluminio nero con retro illuminazione a Led . Senza interruttore.
Ø 65 / Ø 90 cm



PARIS ROUND
Round mirror with 2 led lamps in black finishing, without switch
Specchio rotondo completo di 2 lampade Led in finitura nera, senza interruttore
Ø 90 / Ø 120 cm



PARIS SQUARE
Rectangular mirror with 2 led lamps in black finishing, without switch
Specchio rettangolare completo di 2 lampade Led in finitura nera, senza interruttore
H 80 cm

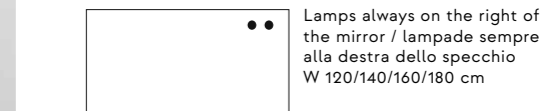
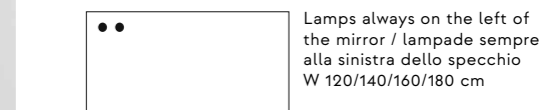
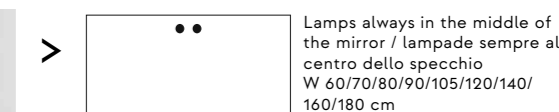

PARIS SQUARE
Rectangular mirror with 4 led lamps in black finishing, without switch
Specchio rettangolare completo di 4 lampade Led in finitura nera, senza interruttore
H 80 cm

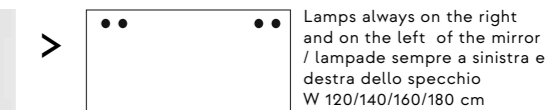

MIRRORS Collection

Specchiere

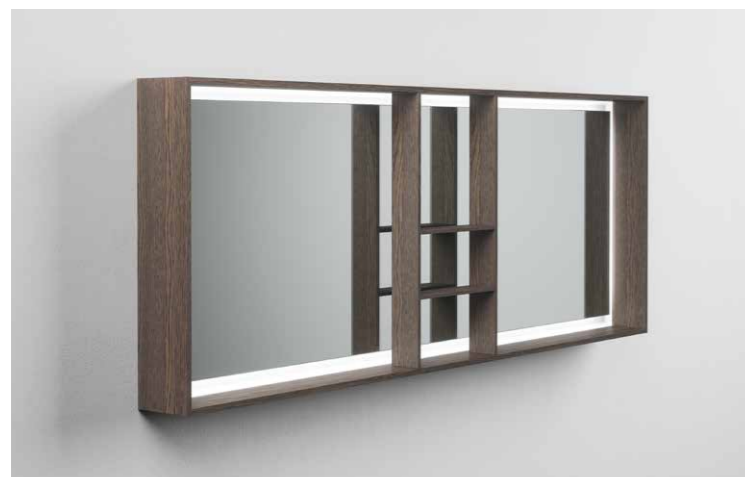

ACCA
Rectangular mirror with perimeter and central shelves lacquered or in wood, complete with led lighting and touch switch with on/off dimmer function
Specchio rettangolare con mensole perimetrali e centrali laccate o in essenza, completo di illuminazione led ed interruttore a sfioramento con funzione on/off dimmer

W 120/140/160/180/210 X D15 X H 80 cm



CHARLES
Rectangular mirror with lacquered or wooden perimeter shelves, complete with LED lighting and touch switch with on/off dimmer function
Specchio rettangolare con mensole perimetrali laccate o in essenza, completo di illuminazione led ed interruttore a sfioramento con funzione on/off dimmer

W 60/70/80/90/105/120 X D15 X H 80 cm



SCREEN
Mirror with 45° lacquered frame. Complete with LED backlighting and touch switch with on / off dimmer function.
Specchio con telaio laccato a 45°. Completo di retro illuminazione a Led ed interruttore touch con funzione on /off dimmer.

W 70/80/90/105/120/140/160/180 X H 80 cm



ALEX
Mirror with matt black aluminum frame with integrated LED lighting on the 4 internal sides. Complete with touch switch.
Specchio con telaio in alluminio nero opaco con illuminazione led integrata sui 4 lati interni. Completa di interruttore touch.

W 80/105/120/140 X H 70 cm

MIRRORS Collection

Specchiere



MY SUN
Mirror with lacquered or wooden frame. Complete with LED backlighting and touch switch with on / off dimmer function.
Specchio con telaio laccato o in essenza. Completo di retro illuminazione a Led ed interruttore touch con funzione on /off dimmer.

W 70/80/90/105/120/140/160/180 X H 80 cm

MIRROR CABINET / SPECCHIO CONTENITORE



NEW VICTORIA
Mirror cabinet with 2/3 external/internal mirrored doors with LED lighting, socket and switch.
Specchio contenitore con 2/3 ante a specchio esterno/interno con illuminazione a Led, presa ed interruttore, incasso murale.

W 60/70/85/105/120/140 X H 80 cm



VOLTAIRE
Mirror cabinet with 2/3 external/internal mirrored doors complete with perimeter LED lighting, socket, and switch.
Specchio contenitore con 2/3 ante a specchio esterno/interno completo di illuminazione perimetrale a LED presa e interruttore

W 60/70/80/105/120/140 X H 80 cm

DEFILÈ Accessories Collection

Defilè Accessori



RING TOWEL HOLDER / PORTASALVIETTE AD ANELLO

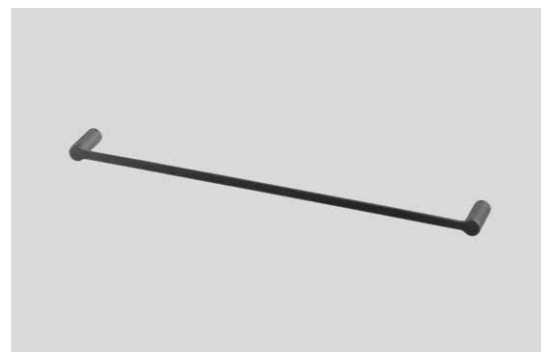

TOWEL RAIL / BARRA PORTASALVIETTE



BATHTUBE TOWEL RACK / GRIGLIA PORTASALVIETTE PER VASCA



DOUBLE HOOK / APPENDINO DOPPIO

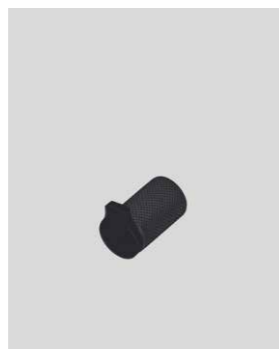

HOOK / APPENDINO



SHOWER SHELF / MENSOLA DOCCIA



TRAY / VASSOIO



WALL MOUNTED PAPER ROLL HOLDER / PORTA-ROTOLO DA PARETE



WALL MOUNTED SPARE PAPER ROLL HOLDER / PORTA-ROTOLO MULTIPOLO DA PARETE

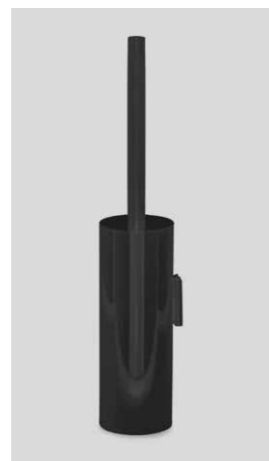

WALL MOUNTED BRUSH HOLDER / PORTA-SCOPINO DA PARETE



FREE STANDING BRUSH HOLDER / PORTA-SCOPINO DA TERRA



WASTE BIN / GETTACARTA

DEFILÈ Accessories Collection

Defilè Accessori



TUMBLER / BICCHIERE



RAZOR HOLDER / PORTA RASOIO



TOOTHBRUSH HOLDER / PORTA SPAZZOLINI



WALL MOUNTED TUMBLER / BICCHIERE DA PARETE



WALL MOUNTED RAZOR HOLDER / PORTA RASOIO DA PARETE



WALL MOUNTED TOOTHBRUSH HOLDER / PORTA SPAZZOLINI DA PARETE



SOAP DISPENSER / DOSASAPONE



SMOOTH SOAP HOLDER / PORTA SAPONE LISCIO



KNURLED SOAP HOLDER / PORTA SAPONE GODRONATO



KLEENEX HOLDER / PORTA KLEENEX



SMOOTH SMALL BOX / SCATOLA LISCIA BASSA



KNURLED SMALL BOX / SCATOLA LISCIA BASSA GODRONATA



SMOOTH LARGE BOX / SCATOLA LISCIA ALTA



KNURLED LARGE BOX / SCATOLA LISCIA ALTA GODRONATA



MAGNIFYING MIRROR / SPECCHIO INGRANDITORE

AVAILABLE FINISHES / FINITURE DISPONIBILI



Chrome
Cromo

Matt black
Nero opaco

Gold
Oro

LAMPS Collection

Collezione Lampade



LAMPS Collection

Collezione Lampade

LAMPS ON THE MIRROR / LAMPADE SULLO SPECCHIO

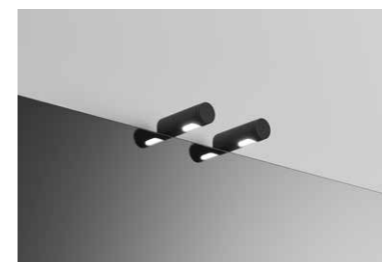

TOOBE - 2 x 5W
Ø 3,8 X D 12 cm

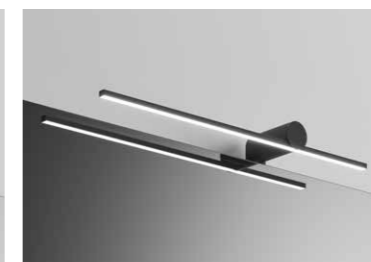

TETRIS DX - 13W
W 72,5 X D 13 X H 6 cm

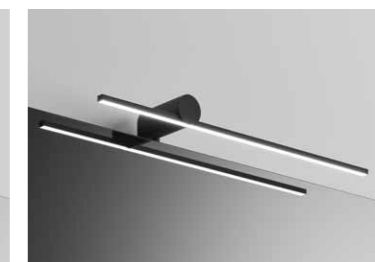

TETRIS SX - 13W
W 72,5 X D 13 X H 6 cm

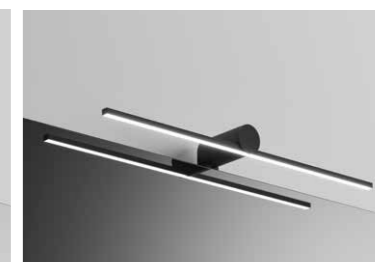

TETRIS - 13W
W 72,5 X D 13 X H 6 cm



LUME DX/SX - 6,2W
W 12 X D 16 X H 39 cm

WALL LAMPS / LAMPADE A PARETE



TETRIS DX - 13W
W 72,5 X D 13 X H 6 cm

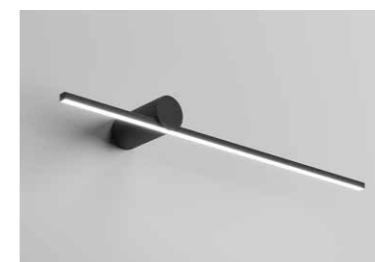

TETRIS SX - 13W
W 72,5 X D 13 X H 6 cm



TETRIS - 13W
W 72,5 X D 13 X H 6 cm



LUME DX/SX - 6,2W
W 12 X D 16 X H 39 cm

SUSPENDED LAMPS / LAMPADE SOPPESE



SEI - 2 x 14W
Bronze finishing / Finitura bronzo
W 100 X D3 X H 2,6 cm



LUME - 6,2W
W 12 X D 12 X H 20 cm

ALL LAMPS ARE AVAILABLE IN MATT BLACK FINISH EXCEPT FOR "SEI LAMP" WHICH IS AVAILABLE IN BRONZE FINISH / TUTTE LE LAMPADE SONO DISPONIBILI IN FINITURA NERO OPACO AD ECCEZIONE DELLA "LAMPADA SEI" CHE È DISPONIBILE IN FINITURA BRONZATA

FINISHING

Finiture

LACQUERED FINISHES / LACCATI

Eden								

G CODE > INDICATES GLOSSY LACQUERED / INDICA LACCATO LUCIDO
 M CODE > INDICATES MATT LACQUERED / INDICA LACCATO OPACO
 D CODE > INDICATES GLOSSY METALLIC / INDICA METALLIZZATO LUCIDO

GLOSSY METALLIC / LACCATI METALLIZZATI

--	--	--	--	--	--

FINISHING

Finiture

WOOD / LEGNI

LEATHER / PELLI - ONLY FOR FRONTAL DRAWERS / SOLO PER FRONTALI CASSETTO

DELUXE PRINT LEATHER / STAMPA PELLE DELUXE - ONLY FOR FRONTAL DRAWERS / SOLO PER FRONTALI CASSETTO

FINISHING

Finiture

COLOURED GLASS / VETRI COLORATI TOP, FRONTAL DRAWERS AND SIDE PANEL / TOP, FRONTALI E FIANCHI

Eden								

VL CODE > INDICATES GLOSSY / INDICA LUCIDO
VS CODE > INDICATES MATT / INDICA OPACO
VD CODE > INDICATES GLOSSY METALLIC / INDICA METALLIZZATO LUCIDO

AVAILABLE VARIANT /
DISPONIBILE NELLA VARIANTE



Vetro colorato
cannettato

FINISHING

Finiture

MARBLE / MARMI - TOP / TOP

PORCELAIN STONE / GRES TOP, FRONTAL DRAWERS AND SIDE PANEL / TOP, FRONTALI E FIANCHI

--	--	--	--	--	--	--	--

FENIX NTM® - TOP / TOP

--	--	--	--	--	--	--	--

FINISHING

Finiture

WHITE/COLOURED MATT PUREFEEL / BIANCO/COLORATO OPACO PUREFEEL TOP / TOP

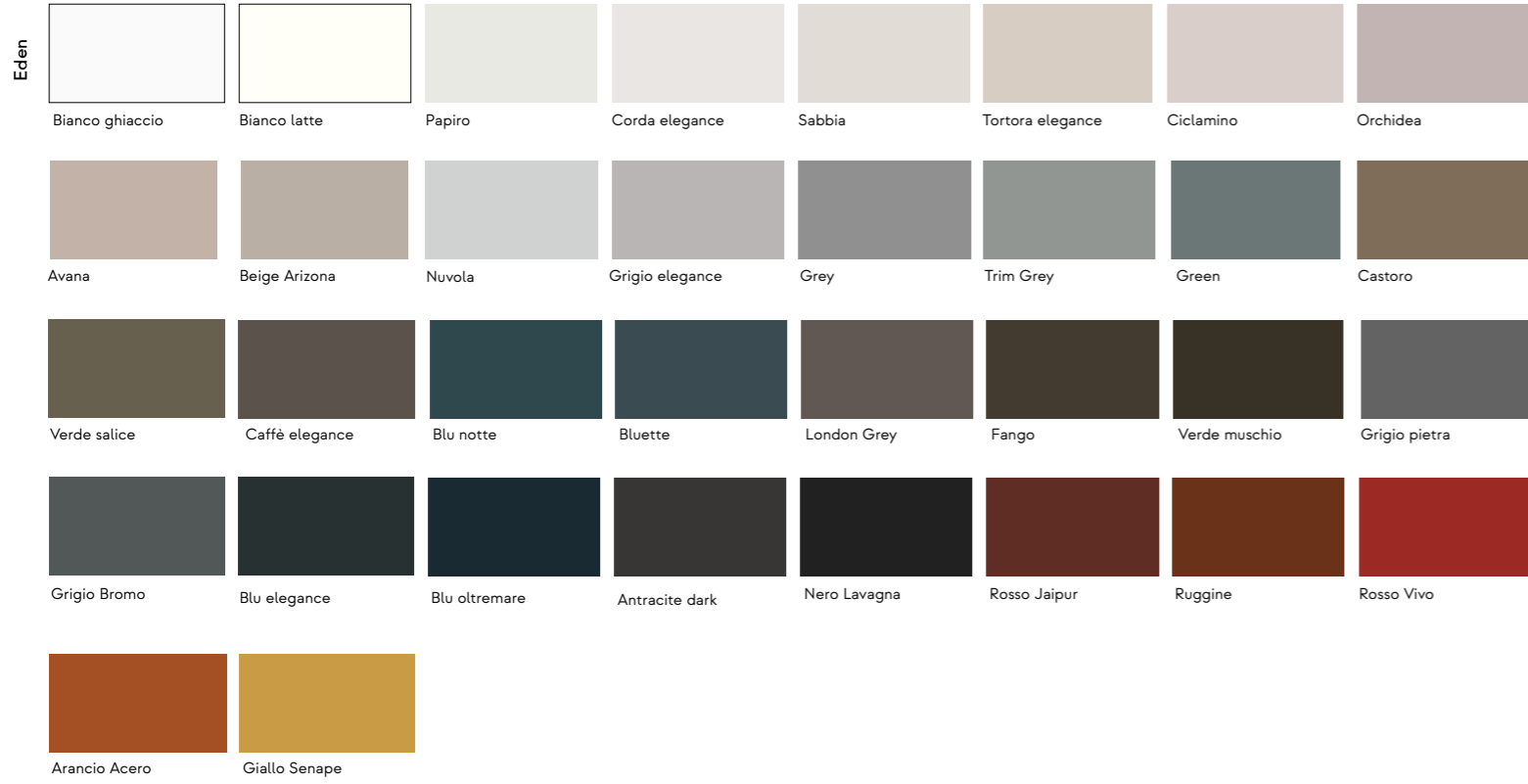

CORIAN® TOP / TOP



Matt White
Bianco opaco

GEACRIL TOP / TOP



Glossy White
Bianco lucido

FINISHING

Finiture

WHITE/COLOURED MATT LIGHTFEEL / BIANCO/COLORATO OPACO LIGHTFEEL TOP / TOP

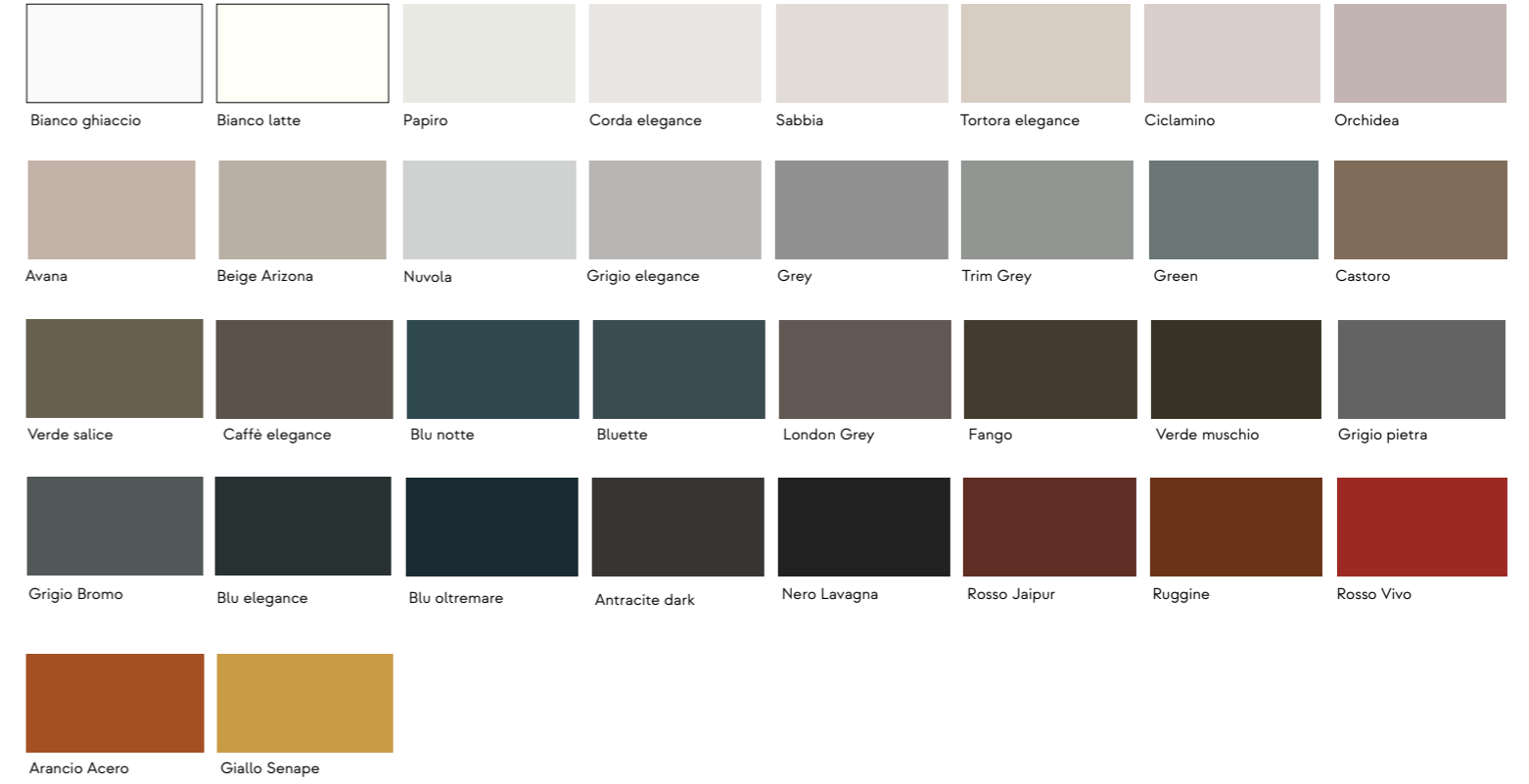

COMPOSITIONS

Composizioni

COMPOSITIONS

Composizioni



EDEN_001
P. 08_19



EDEN_002
P. 20_31



EDEN_003
P. 32_41



EDEN_007
P. 74_85



EDEN_008
P. 86_97



EDEN_009
P. 98_109



EDEN_004
P. 42_51



EDEN_005
P. 52_61



EDEN_006
P. 62_73



EDEN_010
P. 110_119



EDEN_011
P. 120_129



EDEN_012
P. 130_141

COMPOSITIONS

Composizioni



EDEN_013
P. 142_153



EDEN_014
P. 154_163



EDEN_015
P. 164_177



EDEN_016
P. 178_189



EDEN_017
P. 190_199



EDEN_018
P. 200_211