



2022

GRACE *classico*

grace

CARATTERISTICHE
TECNICHE
TECHNICAL FEATURES

Grace indossa un abito classico di intramontabile eleganza, fatto di colori delicati opachi, ante a telaio piene o con vetro rilegato o decorato, per abitare spazi sia piccoli che grandi con gusto e flessibilità.

Lo stile classico le dona un aspetto romantico e intramontabile, dotata di accessori funzionali e dettagli unici, Grace si distingue per equilibrare estetica e praticità con soluzioni adatte alle esigenze del vivere moderno, con elementi tecnologici.

Flessibile e componibile, Grace celebra i piccoli gesti della vita quotidiana.



Grace expresses a classic style of timeless elegance, made of soft matt colors, solid framed doors or with bound or decorated glass, to fit both small and large spaces, with taste and flexibility. The classic style gives it a romantic and timeless look, equipped with functional accessories and unique details. Grace stands out for balancing aesthetics and practicality with solutions suited to the needs of modern living, with technological elements.

Flexible and modular, Grace celebrates the small gestures of everyday life.

cod. **K80**

grace

SP. 20 MM

CARATTERISTICHE TECNICHE

ANTE E FRONTALI CASSETTI

anta in 5 pezzi (conforme **US EPA TSCA Title VI**) in massello di frassino con cartella mdf impiallacciata e laccata a poro aperto nei colori: bianco camelia (opz.2475), grigio reale (opz.2477), argilla decapè (opz.2476), verde cinabro (opz.2479)

anta in 5 pezzi (conforme **US EPA TSCA Title VI**) in massello di frassino con cartella mdf impiallacciata e tinta a poro aperto nel colore: tinto noce (opz.2478)

ANTE VETRO di serie

anta in 5 pezzi (conforme **US EPA TSCA Title VI**) in massello di frassino laccata a poro aperto con inglesina rilegata nickel ottone, vetro extrachiaro trasparente e satinato nei colori: bianco camelia (opz.2475I), grigio reale (opz.2477I), argilla decapè (opz.2476I), verde cinabro (opz.2479I)

anta in 5 pezzi (conforme **US EPA TSCA Title VI**) in massello di frassino tinto a poro aperto con inglesina rilegata nickel ottone, vetro extrachiaro trasparente e satinato nel colore: tinto noce (opz.2478I)

a richiesta

anta in 5 pezzi (conforme **US EPA TSCA Title VI**) in massello di frassino olivato laccata a poro aperto con vetro molato antico "F" nei colori: bianco camelia (opz.2475T), grigio reale (opz.2477T), argilla decapè (opz.2476T), verde cinabro (opz.2479T)

anta in 5 pezzi (conforme **US EPA TSCA Title VI**) in massello di frassino bianco tinto a poro aperto con vetro molato antico "F" nel colore: tinto noce (opz.2478T)

MANIGLIE

vedi pag.14

STRUTTURE DI SERIE

ANTA: FRASSINO BIANCO CAMELIA
nobilitato lino effetto tela (opz.8920) schiena e ripiano conchiglia (opz.8910)

ANTE: FRASSINO ARGILLA DECAPÈ, FRASSINO VERDE CINABRO, FRASSINO TINTO NOCE
nobilitato juta effetto tela (opz.9490) schiena e ripiano visone (opz.948M)

ANTA: FRASSINO GRIGIO REALE
nobilitato grigio effetto tela (opz.9695) schiena e ripiano argilla (opz.9690)



*per componenti si intendono tutte le strutture, alcune ante e alcuni complementi del modello.



GREENGUARD
LE STRUTTURE DELLE CUCINE SONO CONTRADDISTINTE DALLA CERTIFICAZIONE GREENGUARD, PER SODDISFARE GLI STANDARD PIU' RIGOROSI IN TERMINI DI LIVELLI DI EMISSIONE DI COMPOSTI ORGANICI VOLATILI (COV).

MENSOLE

di serie: altezza 3,8 cm in laminato conchiglia (opz.8910), visone (opz.948M), argilla (opz.9690)

a richiesta: altezza 3,8 cm finiture come ante

ZOCCOLI

vedi pag.17



TH. 20 MM

TECHNICAL SPECIFICATIONS

DOORS AND DRAWER FRONT PANELS	<p>door composed of 5 pieces (compliant with US EPA TSCA Title VI) in solid ash with veneered mdf folder and open pore lacquered in the following colors: camelia white (opz.2475), royal grey (opz.2477), clay pickled (opz.2476), cinabro green (opz.2479)</p> <p>door composed of 5 pieces (compliant with US EPA TSCA Title VI), in solid ash with veneered mdf folder and stained open pore in the color: walnut stained (opz.2478)</p>
GLASS DOORS standard	<p>door composed of 5 pieces (compliant with US EPA TSCA Title VI), in open-pore lacquered solid ash with nickel brass bound glass panel, transparent extra-clear and satin glass in the colors: camelia white (opz.2475I), royal grey (opz.2477I), clay pickled (opz.2476I), cinabro green (opz.2479I)</p> <p>door composed of 5 pieces (compliant with US EPA TSCA Title VI), in open-pore stained solid ash with nickel brass bound glass panel, transparent extra-clear and satin glass in the colors: walnut stained (opz.2478I)</p>
on request	<p>door composed of 5 pieces (compliant with US EPA TSCA Title VI), in solid olive ash, open pore lacquered with "F" ground glass in the colors: camelia white (opz.2475T), royal grey (opz.2477T), clay pickled (opz.2476T), cinabro green (opz.2479T)</p> <p>door composed of 5 pieces (compliant with US EPA TSCA Title VI), in open pore stained solid white ash with "F" ground glass in the color: walnut stained (opz.2478T)</p>
HANDLES	<p>see page 14</p>
STANDARD STRUCTURES	<p>DOOR: CAMELIA WHITE ASH linen melamine-coated canvas effect (opt.8920), shell back panel and shelf (opz.8910)</p> <p>DOORS: CLAY PICKLED ASH, CINABRO GREEN ASH, WALNUT STAINED ASH jute melamine-coated canvas effect (opt.9490), mink back panel and shelf (opz.948M)</p> <p>DOOR: ROYAL GREY ASH grey melamine-coated canvas effect (opt.9695), clay back panel and shelf (opz.9690)</p>
SHELVES	<p>standard: 3.8 cm thick, laminate, seashell (opz.8910), mink (opz.948M), clay (opt.9690)</p> <p>on request: 3.8 cm thick, with the same finish as doors</p>
PLINTHS	<p>see page 17</p>

cod. **K80** SP. 20 MM
TH. 20 MM

grace

ante in frassino laccato a poro aperto
lacquered ash doors open pore



frassino bianco camelia
(opz.2475)
camelia white ash



frassino grigio reale
(opz.2477)
royal grey ash

 *colori in pronta consegna
available colours*

anta laccata decapata a poro aperto
lacquered pickled door open pore



frassino argilla decapè
(opz.2476)
clay pickled ash

SP. 20 MM
TH. 20 MM

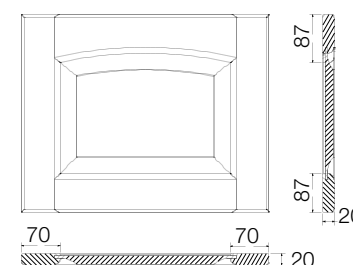

cod. **K80** SP. 20 MM
TH. 20 MM

grace

anta in frassino tinto a poro aperto
stained ash door open pore



frassino tinto noce
(opz.2478)
walnut stained ash

anta in frassino laccato a poro aperto
lacquered ash door open pore



frassino verde cinabro
(opz.2479)
cinabro green ash

SP. 20 MM
TH. 20 MM

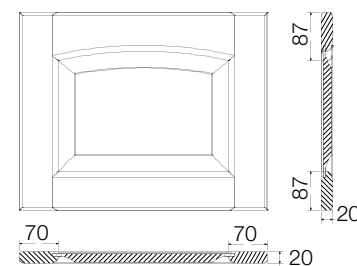

cod. **K80** SP. 20 MM
TH. 20 MM

grace

ante vetro rilegato con inglesina telaio di frassino laccato a poro aperto
glass panelled bound door, open pore lacquered ash frame



frassino bianco camelia
(opz.2475l) rilegatura nickel
con vetro extrachiaro
trasparente e satinato
camellia white ash
(opt. 2475l) nickel binding
with transparent, extra-clear
and satin glass

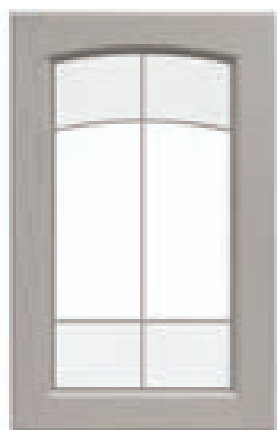

frassino grigio reale
(opz.2477l) rilegatura nickel
con vetro extrachiaro
trasparente e satinato
royal grey ash
(opt. 2477l) nickel binding
with transparent, extra-clear
and satin glass

 *colori in pronta consegna
available colours*

anta vetro rilegato con inglesina telaio di frassino laccato decapato a poro aperto
glass panelled bound door, lacquered pickled ash frame



frassino argilla decapè
(opz.2476l) rilegatura nickel
con vetro extrachiaro
trasparente e satinato
clay pickled ash
(opt. 2476l) nickel binding
with transparent, extra-clear
and satin glass

SP. 20 MM
TH. 20 MM

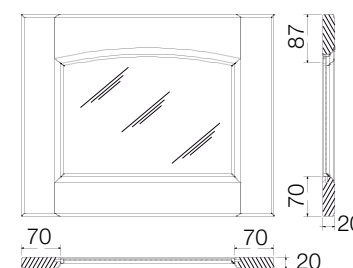

cod. **K80** SP. 20 MM
TH. 20 MM

grace

anta vetro rilegato con inglesina telaio di frassino tinto a poro aperto
glass panelled bound door, open pore stained ash frame



frassino tinto noce
(opt.2478I) rilegatura nickel
con vetro extrachiaro
trasparente e satinato
walnut stained ash
(opt. 2478I) nickel binding with
transparent, extra-clear and
satin glass

anta vetro rilegato con inglesina telaio frassino laccato a poro aperto
glass panelled bound door, open pore lacquered ash frame



frassino verde cinabro
(opt.2479I) rilegatura nickel
con vetro extrachiaro
trasparente e satinato
cinabro green ash
(opt. 2479I) nickel binding with
transparent, extra-clear and
satin glass

SP. 20 MM
TH. 20 MM

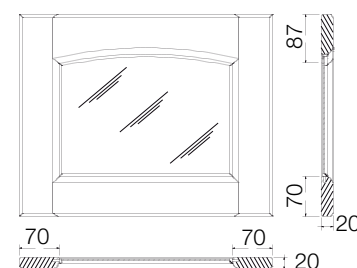

cod. **K80** SP. 20 MM
TH. 20 MM

grace

ante vetro molato telaio di frassino laccato a poro aperto
ground glass doors open pore lacquered ash frame



frassino bianco camelia
(opt.2475T) con vetro
molato antico "F"
camellia white ash
(opt.2475T) with "F"
antique ground glass



frassino grigio reale
(opt.2477T) con vetro
molato antico "F"
royal grey ash
(opt.2477T) with "F"
antique ground glass

 *colori in pronta consegna
available colours*

anta vetro molato telaio di frassino laccato decapato a poro aperto
ground glass door open pore pickled lacquered ash frame



frassino argilla decapè
(opt.2476T) con vetro
molato antico "F"
clay pickled ash
(opt.2476T) with "F"
antique ground glass

SP. 20 MM
TH. 20 MM

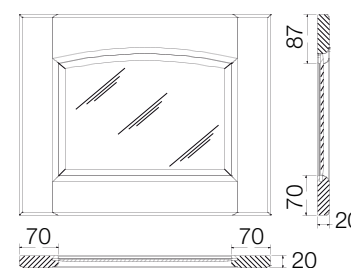

cod. **K80** SP. 20 MM
TH. 20 MM

grace

anta vetro molato telaio di frassino tinto a poro aperto
ground glass door with open pore stained ash frame



frassino tinto noce
(opz.2478T) con vetro
molato antico "F"
walnut stained ash
(opt.2478T) with "F"
antique ground glass

anta vetro molato telaio frassino laccato a poro aperto
ground glass door with open pore lacquered ash frame

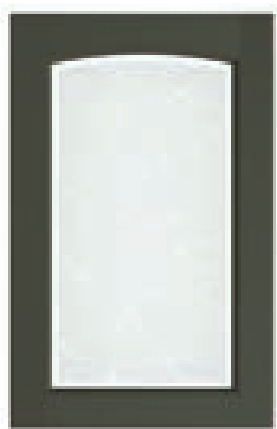

frassino verde cinabro
(opz.2479T) con vetro
molato antico "F"
cinabro green ash
(opt.2479T) with "F"
antique ground glass

SP. 20 MM
TH. 20 MM

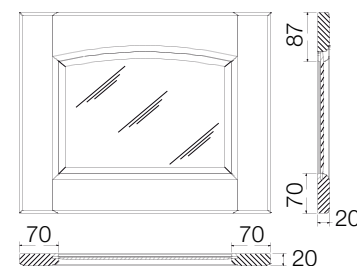

MANIGLIE HANDLES

DI SERIE STANDARD



Maniglia 175 finitura silver dark
anta L 15 → passo 96 mm
anta da L 30 a 90 → passo 160 mm

Handle 175 dark silver finish
door W 15 → centre-to-centre distance 96 mm
door from W 30 to W 90 → centre-to-centre distance 160 mm

A RICHIESTA ON REQUEST



Maniglia 176 finitura ottone
anta L 15 → pomo passo 16 mm
anta da L 30 a 90 → passo 128 mm

Handle 176 brass finish
door W 15 → knob centre-to-centre distance 16 mm
door from W 30 to W 90 → centre-to-centre distance 128 mm

A RICHIESTA ON REQUEST



Maniglia 172A finitura argento vecchio brillante
anta L 15 → passo 96 mm
anta da L 30 a 90 → passo 160 mm

Handle 172A polished old silver finish
door W 15 → centre-to-centre distance 96 mm
door from W 30 to W 90 → centre-to-centre distance 160 mm

A RICHIESTA ON REQUEST



Maniglia 228 finitura ottone vecchio
inserto avorio
passo 128 mm
Handle 228 with old brass finish
with ivory insert
128 mm centre-to-centre distance



Pomo 228P finitura ottone vecchio
utilizzata per elementi da 15
con maniglia 228
Knob hole 228P with old brass finish
used for 15 cm elements with handle 228

A RICHIESTA ON REQUEST



Maniglia 230 finitura argento antico
passo 128 mm
Handle 230 with antique silver finish
128 mm centre-to-centre distance



Pomo 200P finitura argento antico
passo 16 mm
Knob hole 200P antique silver finish
centre-to-centre distance 16 mm

A RICHIESTA ON REQUEST



Maniglia 255P finitura piombo spazzolato
passo 160 mm
Handle 255P brushed lead finish
160 mm centre-to-centre distance



Pomo 255PP finitura piombo spazzolato
utilizzato per elementi da 15
con maniglia 255P
Knob hole 255PP antique lead finish
used for 15 cm elements with handle 255P

A RICHIESTA ON REQUEST



Maniglia 255N finitura nichel satinato
passo 160 mm
Handle 255N nickel satin finish
160 mm centre-to-centre distance



Pomo 255NP finitura nichel satinato
utilizzato per elementi da 15
con maniglia 255N
Knob hole 255NP antique nickel satin finish
used for 15 cm elements with handle 255N

A RICHIESTA ON REQUEST



Maniglia 255R finitura rame antico
passo 160 mm
Handle 255R antique copper finish
160 mm centre-to-centre distance



Pomo 255RP finitura rame antico
utilizzato per elementi da 15
con maniglia 255R
Knob hole 255RP antique copper finish
used for 15 cm elements with handle 255R

A RICHIESTA ON REQUEST



Maniglia 255T finitura ottone antico
passo 160 mm
Handle 255T antique brass finish
160 mm centre-to-centre distance



Pomo 255TP finitura ottone antico
utilizzato per elementi da 15
con maniglia 255T
Knob hole 255TP antique brass finish
used for 15 cm elements with handle 255T



strutture carcasses



lino effetto tela (opz.8920)
schiena e ripiano conchiglia
(opz.8910)
linen melamine-coated canvas
effect (opt.8920)
seashell back panel and shelf
(opt.8910)



juta effetto tela (opz.9490)
schiena e ripiano visone
(opz.948M)
jute melamine-coated canvas
effect (opt.9490)
mink back panel and shelf
(opt.948M)



grigio effetto tela (opz.9695)
schiena e ripiano argilla
(opz.9690)
grey melamine-coated canvas
effect (opt.9695)
clay back panel and shelf
(opt.9690)



*per componenti si intendono tutte le strutture, alcune ante e alcuni complementi del modello.



GREENGUARD
LE STRUTTURE DELLE CUCINE SONO CONTRADDISTINTE DALLA CERTIFICAZIONE GREENGUARD, PER SODDISFARE GLI STANDARD PIU' RIGOROSI IN TERMINI DI LIVELLI DI EMISSIONE DI COMPOSTI ORGANICI VOLATILI (COV).

mensole in laminato laminate shelves



conchiglia (opz.8910)
seashell (opt.8910)



visone (opz.948M)
mink (opt.948M)



argilla (opz.9690)
clay (opt.9690)

mensole impialacciate veneered shelves



impialacciata come anta
N.B.: per le finiture vedi colore ante pag.8-9
veneered same finish as door
Note: for the finishes see door colours see page 8-9

zoccoli in pvc H 13 pvc plinths H 13



argilla decapè (opz.587)
clay pickled (opt.587)



bianco camelia (opz.606)
camelia white (opt.606)



tinto noce (opz.589)
walnut stained (opt.589)

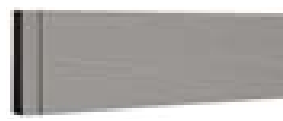

grigio reale (opz.595)
royal grey (opt.595)

zoccolo in alluminio H 13 aluminium plinth H 13

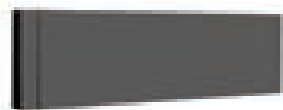

alluminio finitura silver dark
(opz.9507)
aluminium dark silver finish
(opt.9507)



alluminio finitura titanio ossidato
(opz.414)
aluminium titanium oxidized finish
(opt.414)



alluminio finitura ottone
(opz.7761)
aluminium brass finish
(opt.7761)

cornici cappello top cornices



argilla decapè (opz.2476)
clay pickled (opt.2476)

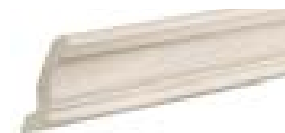

bianco camelia (opz.2475)
camelia white (opt.2475)

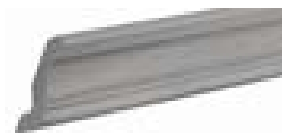

grigio reale (opz.2477)
royal grey (opt.2477)



tinto noce (opz.2478)
walnut stained (opt.2478)



verde cinabro (opz.2479)
cinabro green (opt.2479)

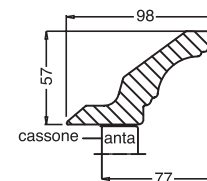

disegno cornice
design cornice

MODULARITÀ E COMPONIBILITÀ MODULARITY AND FITTING SOLUTIONS

BASI H 73
BASE UNITS H 73

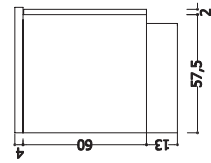

BASI SOSPESE
HANGING BASE UNITS

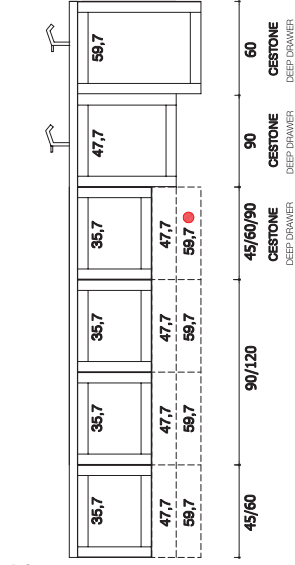
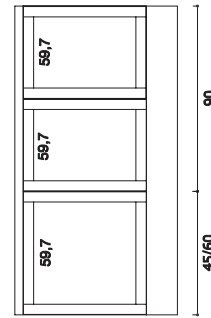

BASI LIVING
LIVING BASE UNITS

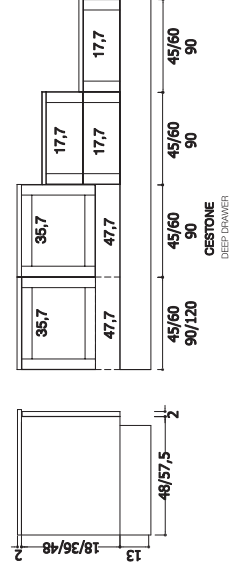

COLONNE FRIGO
FRIDGE COLUMNS

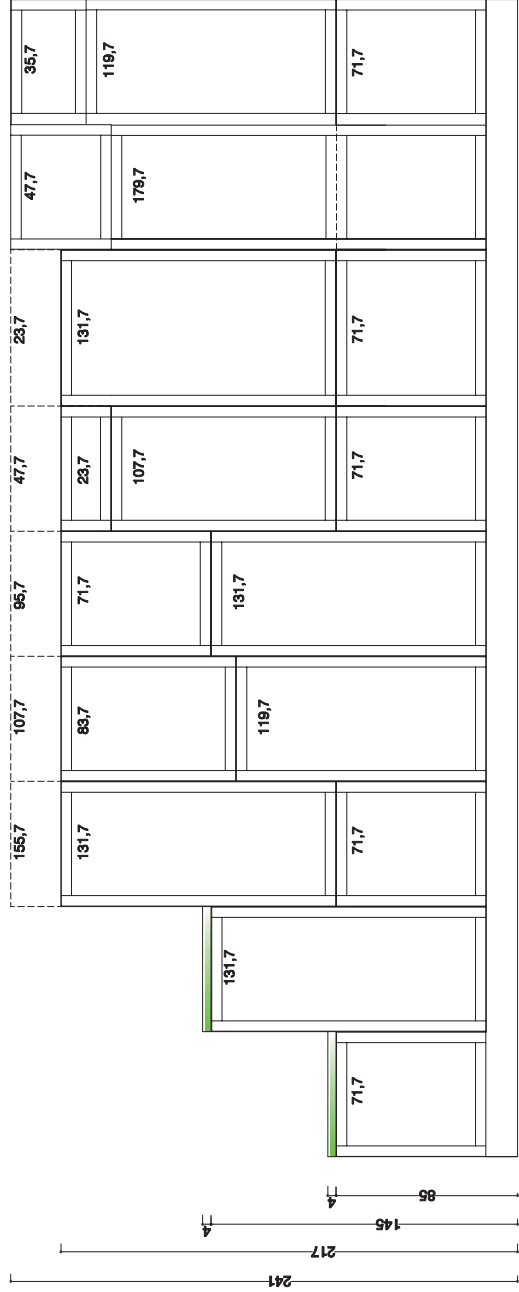
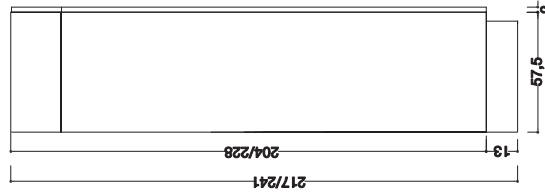

● **ESCLUSO 90**
EXCLUDING 90

- 60** FRIGO CONG. SOTTOTOP UNDER TOP FRIDGE FREEZER 315 LT 330 LT
- 60** FRIGO CONG. MONOPORTA SINGLE DOOR FRIDGE FREEZER 300 LT
- 60** FRIGO CONG. 1 MOTORE LT 315 - LT 330 FRIDGE FREEZER 315 LT 330 LT
- 60** FRIGO LT 215 FRIGGE 215 LT
- 60** FRIGO CONG. LT 315 3 ANTE FRIDGE FREEZER 315 LT 3 DOORS
- 75** FRIGO CONG. LT 400 FRIDGE FREEZER 400 LT
- 60** FRIGO CONG. LT 300 MONOPORTA SINGLE DOOR FRIDGE FREEZER 300 LT
- 60** FRIGO CONG. LT 330 3 ANTE FRIDGE FREEZER 330 LT 3 DOORS

COLONNE FORNO
OVEN COLUMNS

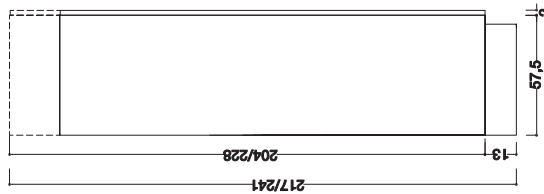

PENSILI RIBALTA CHIUSURA AMMORTIZZATA

FLAP DOOR WALL UNITS BLUMOTION CLOSING SYSTEM

PENSILE CON APERTURA A RIBALTA

Le ante aprendosi verso l'alto consentono di avere un' ampia visione d'insieme all'interno del mobile. In questo modo è possibile un comodo accesso agli oggetti contenuti al suo interno e, dal punto di vista ergonomico, molto vantaggioso. La regolazione della forza di apertura può essere impostata in modo esatto in base al peso del frontale. Grazie all'arresto progressivo le ante si fermano in qualsiasi posizione; in questo modo la maniglia è sempre facilmente raggiungibile. La chiusura è ammortizzata di serie.

WALL UNIT WITH FLAP DOOR

The doors that open upwards guarantee ample overall visibility inside the cabinet. In this way, all objects housed inside the cabinet can be comfortably accessed, making the system highly advantageous from an ergonomic perspective. The opening force can be adjusted precisely according to the weight of the front. The doors stop in any position thanks to the gradual stopping movement; in this way, the handle is always easily accessible. The closing movement is cushioned standard

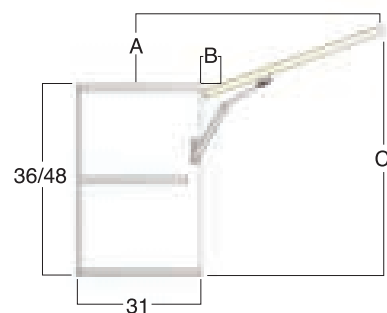

	A	B	C
H 36	10	2,3	46
H 48	13	2,3	61



Grazie al meccanismo TIP-ON, le ante a ribalta senza maniglia possono essere aperte semplicemente con un leggero tocco. Per chiudere l'anta a ribalta, è sufficiente esercitare una leggera pressione, che grazie ad una piastrina di bloccaggio, applicata sul lato interno del frontale, ne assicura la perfetta chiusura.

Thanks to TIP-ON mechanism, the flap doors without handles can be opened with a simple touch. To close the flap door, just exercise light pressure, thanks to the locking plate, applied on the inner side of the front panel ensures a perfect closure.

PENSILI APERTURA A PACCHETTO

WALL UNITS FOLDING DOORS

PENSILE CON APERTURA ANTE A PACCHETTO

Il meccanismo d'apertura ante a pacchetto è idoneo sia sul pensile H 72 che H 96; la regolazione della forza di apertura può essere impostata in modo esatto in base ai pesi dei frontali, la chiusura è ammortizzata e la cerniera centrale clip si contraddistingue per l'innovativa tecnologia che garantisce la sicurezza per le dita.

WALL UNIT WITH LIFT-UP FOLDING DOORS

The lift-up folding door opening mechanism is suitable for wall units with H 72 or H 96; the opening force can be adjusted precisely according to the weight of the fronts, while the closing movement is cushioned and the central clip-on hinge features innovative technology for safeguarding the fingers.



H 72



H 96

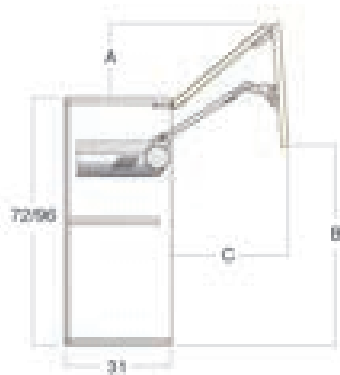

	A	B	C
H 72	19,5	54	41
H 96	24,7	69	53

SCHEMA MONTAGGIO LIMITATORE LIMITER INSTALLATION DIAGRAM

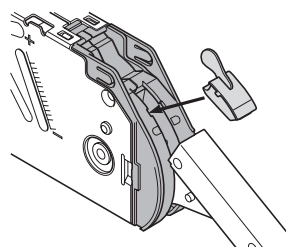
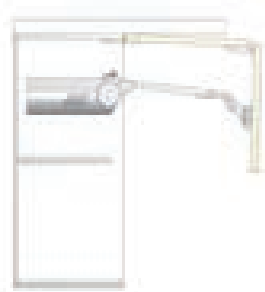

Per evitare l'interferenza dell'anta in fase di apertura con cornici o mensole, si può richiedere il limitatore dell'angolo di apertura cod. 5620005

In order to avoid that the door interferes with cornices or shelves during the opening movement, it is possible to request an opening angle limiter: code 5620005

CAPPA DESIRÈ

DESIRÈ HOOD

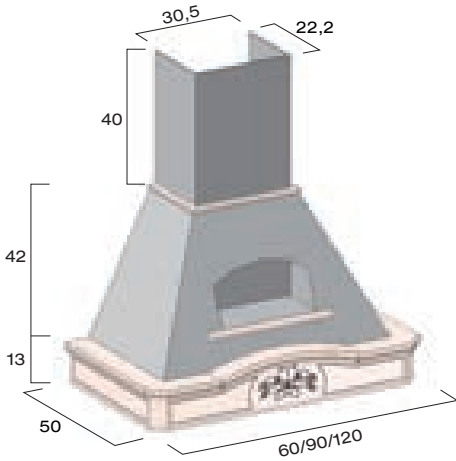
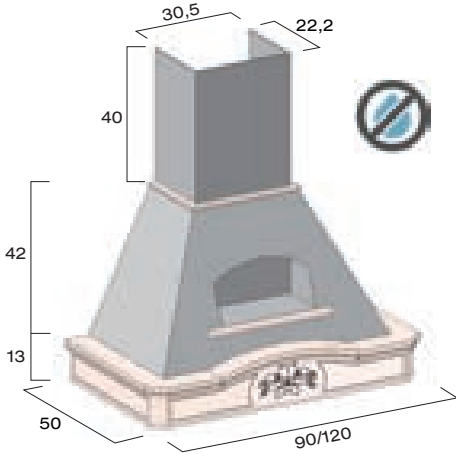

	COD.					
<p>cappa DESIRÈ con camino metallo in tinta e nicchia portata 645 m³/h, fascione e cornice in massello, colore come anta impiallacciata DESIRÈ hood with metal chimney matching with band and niche air flow rate 645 m³/h, band and cornice in solid wood, same colour as veneered door</p> 	<p>bianco L 60 03993850B L 90 03993851B L 120 03993852B</p> <p>silver dark L 60 03993850S L 90 03993851S L 120 03993852S</p> <p>ottone L 60 03993850T L 90 03993851T L 120 03993852T</p> <p>filtra carbone attivo L 60 active carbon filter 08750999G filtra carbone attivo L 90-120 active carbon filter 08750999B</p>					
<p>cappa DESIRÈ con camino metallo in tinta e nicchia, NO DRIP portata 350 m³/h, fascione e cornice in massello, colore come anta impiallacciata DESIRÈ hood with metal chimney matching with band and niche, NO DRIP air flow rate 350 m³/h, band and cornice in solid wood, same colour as veneered door</p> 	<p>bianco L 90 03993856B L 120 03993857B</p> <p>silver dark L 90 03993856S L 120 03993857S</p> <p>ottone L 90 03993856T L 120 03993857T</p> <p>filtra carbone attivo active carbon filter 08750999F</p>					

CAPPA EGIZIA

EGIZIA HOOD



cappa EGIZIA con camino metallo in tinta e orologio
portata 645 m³/h, fascione e cornice in massello, colore come anta
impiallacciata

EGIZIA hood with metal chimney matching with band and clock
 air flow rate 645 m³/h, band and cornice in solid wood, same colour as veneered door

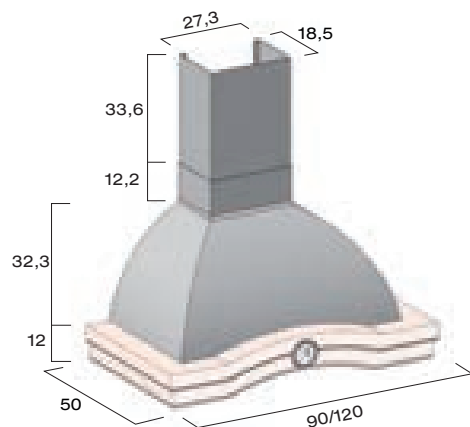

- bianco L 90
- L 120
- silver dark L 90
- L 120
- ottone L 90
- L 120
- filtro carbone attivo
active carbon filter

COD.						
03993861B						
03993862B						
03993861S						
03993862S						
03993861T						
03993862T						
08750999B						

cappa EGIZIA con camino metallo in tinta e orologio, NO DRIP
portata 350 m³/h, fascione e cornice in massello, colore come anta
impiallacciata

EGIZIA hood with metal chimney matching with band and clock, NO DRIP
 air flow rate 350 m³/h, band and cornice in solid wood, same colour as veneered door

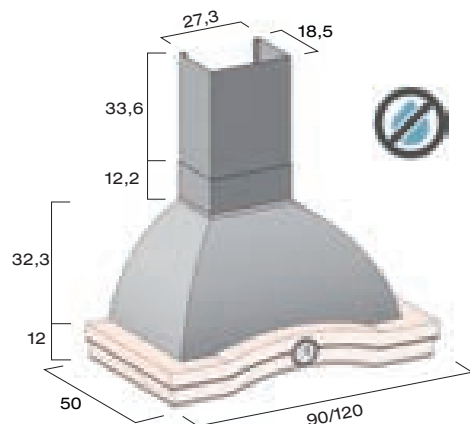

- bianco L 90
- L 120
- silver dark L 90
- L 120
- ottone L 90
- L 120
- filtro carbone attivo
active carbon filter

03993866B						
03993867B						
03993866S						
03993867S						
03993866T						
03993867T						
08750999F						

CAPPA PORTRAIT

PORTRAIT HOOD

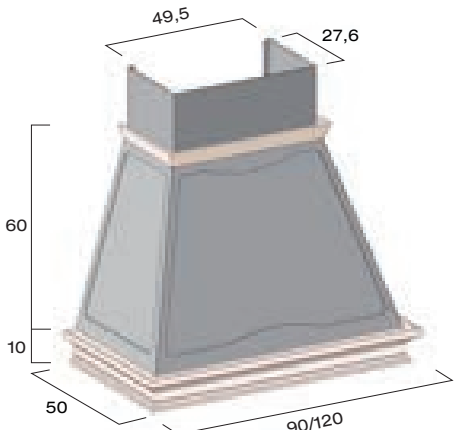
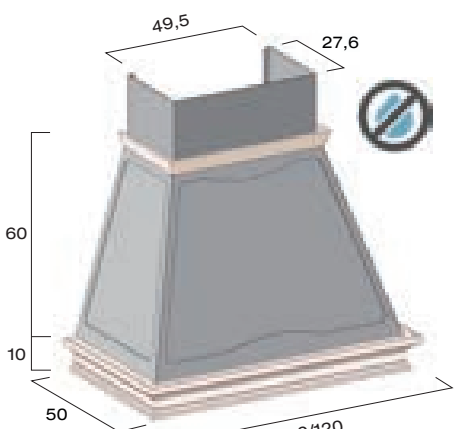

	COD.					
<p>cappa PORTRAIT con camino metallo in tinta portata 645 m³/h, fascione e cornice in massello, colore come anta impiallacciata PORTRAIT hood with metal chimney matching with band air flow rate 645 m³/h, band and cornice in solid wood, same colour as veneered door</p> 						
<p>bianco L 90 03993871B</p> <p>L 120 03993872B</p>						
<p>silver dark L 90 03993871S</p> <p>L 120 03993872S</p>						
<p>ottone L 90 03993871T</p> <p>L 120 03993872T</p>						
<p>filtro carbone attivo active carbon filter 08750999B</p>						
<p>cappa PORTRAIT con camino metallo in tinta, NO DRIP portata 350 m³/h, fascione e cornice in massello, colore come anta impiallacciata PORTRAIT hood with metal chimney matching with band, NO DRIP air flow rate 350 m³/h, band and cornice in solid wood, same colour as veneered door</p> 						
<p>bianco L 90 03993876B</p> <p>L 120 03993877B</p>						
<p>silver dark L 90 03993876S</p> <p>L 120 03993877S</p>						
<p>ottone L 90 03993876T</p> <p>L 120 03993877T</p>						
<p>filtro carbone attivo active carbon filter 08750999F</p>						

CAPPA VIENNA

VIENNA HOOD



	COD.					
<p>cappa VIENNA con camino metallo in tinta e nicchia portata 645 m³/h, fascione e cornice in massello, colore come anta impiallacciata VIENNA hood with metal chimney matching with band and niche air flow rate 645 m³/h, band and cornice in solid wood, same colour as veneered door</p>						
	L 90					
	bianco	03993881B				
	silver dark	03993881S				
	ottone	03993881T				
	filtro carbone attivo active carbon filter	08750999B				
<p>cappa VIENNA con camino metallo in tinta e nicchia portata 350 m³/h, fascione e cornice in massello, colore come anta impiallacciata VIENNA hood with metal chimney matching with band and niche air flow rate 350 m³/h, band and cornice in solid wood, same colour as veneered door</p>						
	L 90					
	bianco	03993886B				
	silver dark	03993886S				
	ottone	03993886T				
	filtro carbone attivo active carbon filter	08750999F				



TIPOLOGIE CAPPE CAMINO

CHIMNEY HOOD TYPES

cappa tipo "S" vedi pag. 52

chimney type "S"
see page 52



cappa tipo "S2" vedi pag. 54

chimney type "S2"
see page 54



cappa tipo "E" vedi pag. 56

chimney type "E"
see page 56



cappa tipo "SN" vedi pag. 58

chimney type "SN"
see page 58



TIPOLOGIE CAPPE CAMINO

CHIMNEY HOOD TYPES

cappa isola
vedi pag. 59

chimney island
see page 59



SCHEMA CAPPA CAMINETTO AD ANGOLO

CORNER CHIMNEY HOOD DIAGRAM

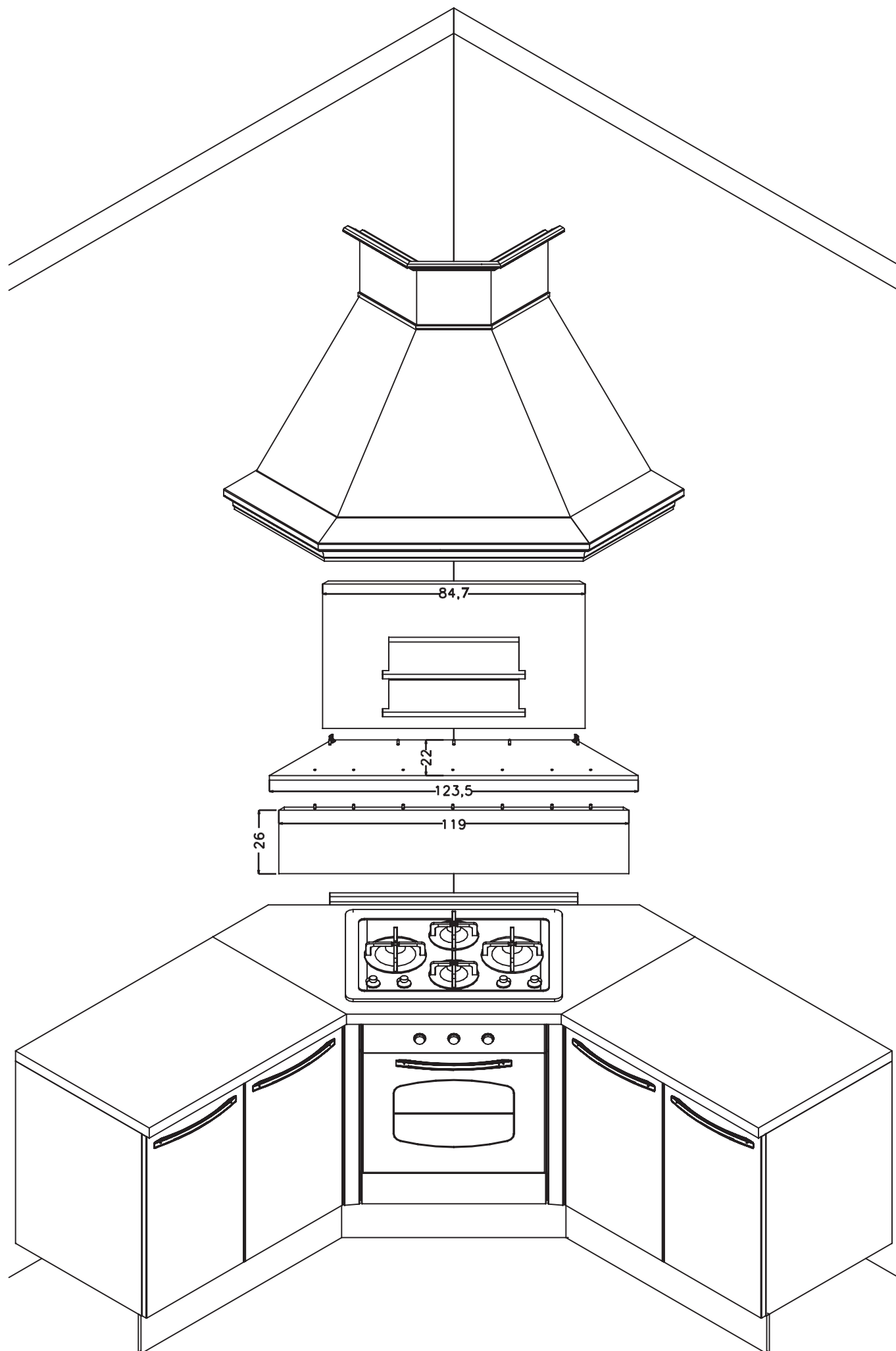





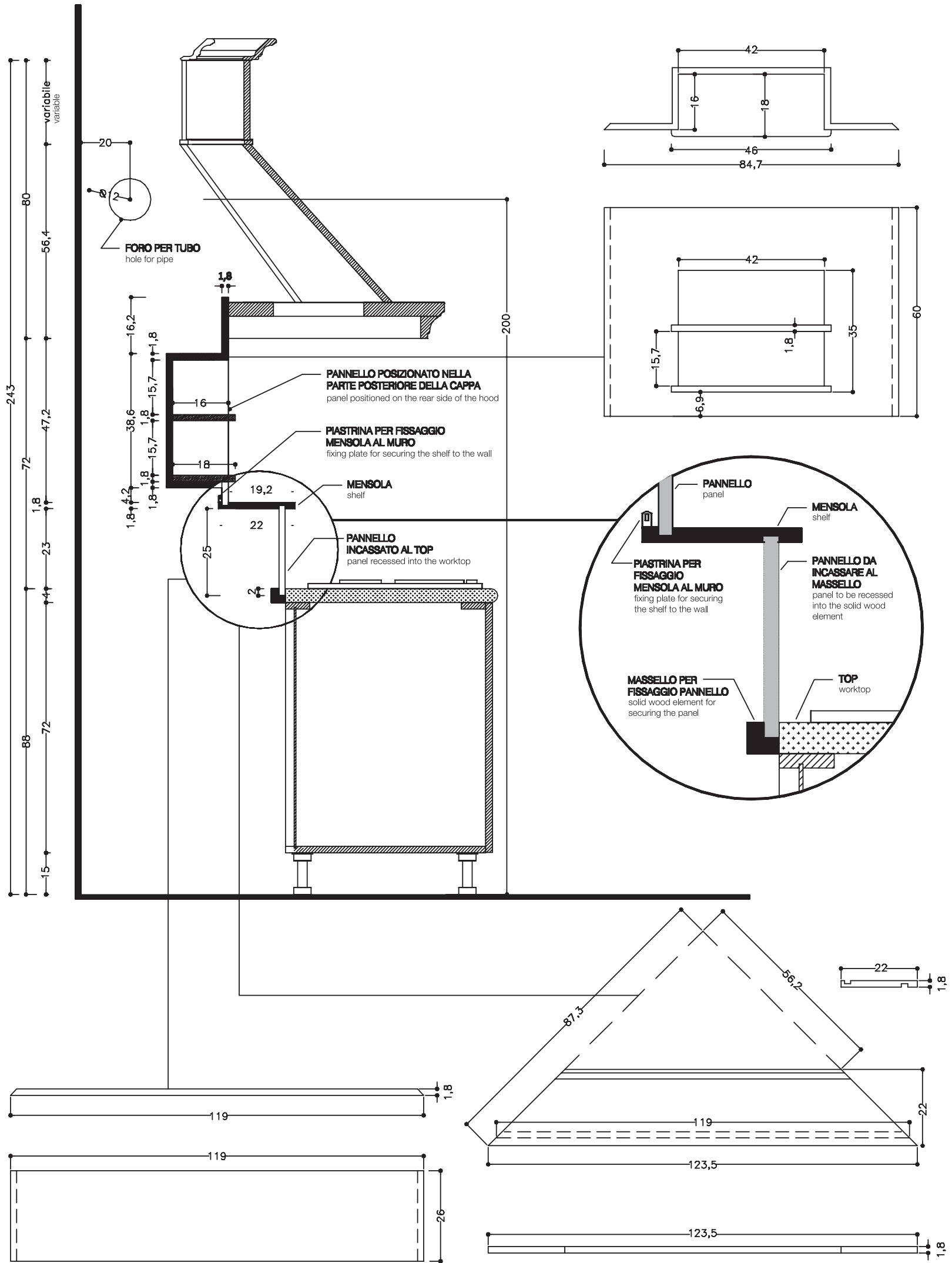







SCHEMA CAPPA CAMINETTO AD ANGOLO

CORNER CHIMNEY HOOD DIAGRAM



MENSOLE



SHELVES

	CODICE				CODICE	FASCIA A	FASCIA B
<p>mensola sp.3,8 in laminato L. max cm 400 lamine shelf th.3,8 max length 400 cm</p>  <p>finiture: finishes</p> <div style="display: flex; justify-content: space-around;"> <div style="text-align: center;">  <p>conchiglia (opz.8910) seashell</p> </div> <div style="text-align: center;">  <p>visone (opz.948M) mink</p> </div> </div> <div style="margin-top: 10px;">  <p>argilla (opz.9690) clay</p> </div> <p style="text-align: right;">al ml per lm P 31</p> <p style="text-align: right;">magg. reggimensola a scomparsa surcharge fully integrated shelf bracket P 61</p>	091523 08610400 091560						
<p>mensola soprapensile impiallacciata con schienale e cornice sagomata above-wall unit veneered shelf with back panel and shaped frame</p>  <p style="text-align: right;">L 60 E8730600 L 90 E8730900 L 120 E8731200</p>							
<p>mensola soprapensile impiallacciata con cornice sagomata above-wall unit veneered shelf with shaped frame</p>  <p style="text-align: right;">L 60 E8750600 L 90 E8750900 L 120 E8751200</p>							
<p>mensola sp.3,8 impiallacciata colore come anta L. max cm 250</p> <p>n.b.: quantità minima fatturabile 0,5 ml</p>  <p>veneered shelf th.3,8 colour matching with door max: length 250 cm</p> <p>note: minimum invoiceable quantity 0,5 lm</p> <div style="display: flex; justify-content: space-around; margin-top: 10px;"> <div style="text-align: center;">  <p>frassino bianco camelia (opz.2475) camelia white ash</p> </div> <div style="text-align: center;">  <p>frassino grigio reale (opz.2477) royal grey ash</p> </div> </div> <div style="margin-top: 10px;"> <div style="display: flex; justify-content: space-around;"> <div style="text-align: center;">  <p>frassino argilla decapè (opz.2476) clay pickled ash</p> </div> <div style="text-align: center;">  <p>frassino tinto noce (opz.2478) walnut stained ash</p> </div> </div> <div style="margin-top: 10px;">  <p>frassino verde cinabro (opz.2479) cinabro green ash</p> </div> <p style="text-align: right;">al ml per lm P 31</p> <p style="text-align: right;">magg. reggimensola a scomparsa surcharge fully integrated shelf bracket P 61</p> </div>	091723 08610400 091729						

ANTE-FIANCHI DI
FINITURA-MENSOLE
DOORS-FINISHING PANELS-SHELVES

MENSOLE - CORNICI

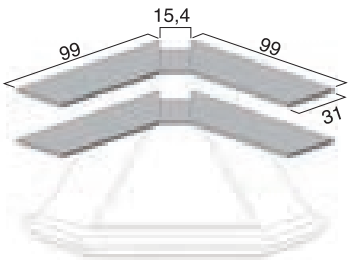
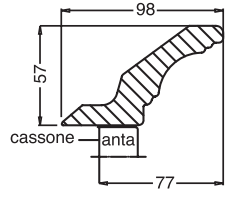
SHELVES - CORNICES

	CODICE				CODICE			
<p>mensole prof.31 per cappa caminetto ad angolo shelves D 31 for corner chimney hood</p>  <p>Laminato Laminate nr.2 da 99 taglio 45° dx 2x99 cm 45° cut RH nr.2 da 99 taglio 45° sx 2x99 cm 45° cut LH nr.2 da 15,4 taglio dritto 2x15,4 cm straight cut</p> <p>Impiallacciata Veneered nr.2 da 99 taglio 45° dx 2x99 cm 45° cut RH nr.2 da 99 taglio 45° sx 2x99 cm 45° cut LH nr.2 da 15,4 taglio dritto 2x15,4 cm straight cut</p>	091523				<p>cornice cappello (per motivi tecnici le cornici in angoli fuori squadra non si possono inviare tagliate) top cornice (for technical reasons, cornices for out-of-plumb corners cannot be shipped already cut)</p>   <p>al ml per lm</p>	093010		

SCHIENALE DOGATO IMPIALLACCIATO COLORE COME ANTA

VENEERED BACK PANEL WITH STRIPES, SAME COLOUR AS DOOR

	<p>Particolare schienale dogato Detail of the stripes back</p> <p>N.B.: quantità minima fatturabile 0,5 mq Note: minimum invoiceable quantity 0,5 m²</p>
--	---

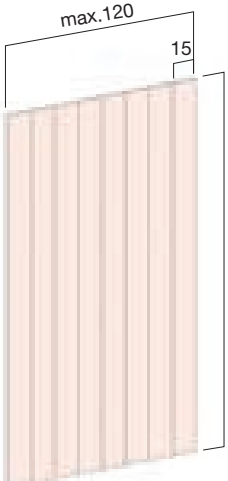
	CODICE				CODICE		
<p>Schienale dogato sp. 18 mm. colore come anta striped back panel th. 18 mm same colour as door</p>  <p>al mq per m²</p>	094341						

ISOLA IN LEGNO

WOOD ISLAND

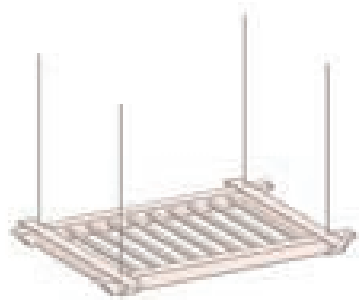

	COD.					
<p>isola in legno con 3 cassetti e ripiano grigliato colore come anta wood island with 3 drawers and wire shelf same colour as door</p>  <p style="text-align: right;">L 180 H 89 P 90</p>	E4951100					
<p>elemento sopra isola in legno colore come anta wood over island unit same colour as door</p>  <p style="text-align: right;">L 120 H 6 P 90</p>	08605970					

ELEMENTI DI
COMPLEMENTO
ACCESSORY ELEMENTS

SOTTOPENSILI IN LEGNO COLORE COME ANTA

WOOD UNDERMOUNT WALL UNITS SAME COLOUR AS DOOR



		COD.					
 <p>sottopensile in legno con mensola H 17 P 27 colore come anta wood undermount wall unit with shelf H 17 D 27 same colour as door</p>	L 45	08603412					
	L 60	08603414					
	L 90	08603416					
 <p>sottopensile in legno portabottiglie H 17 P 27 colore come anta wood undermount wall unit with bottle holder H 17 D 27 same colour as door</p>	L 45	08603422					
	L 60	08603424					
	L 90	08603426					
 <p>sottopensile in legno sagomato con mensola e ganci H 24,8 P 31 colore come anta shaped wood undermount wall unit with shelf and hooks H 24,8 D 31 same colour as door</p>	L 45	08603402					
	L 60	08603404					
	L 90	08603406					

LIVING

Spazi coordinati per avere un solo ambiente per cucinare, ricevere gli amici, pranzare e rilassarsi è una soluzione al desiderio di vivere la casa più liberamente, secondo stili di vita contemporanei, integrando cucina e living all'insegna di un nuovo linguaggio progettuale.

Coordinated spaces that create a single environment in which to cook, receive friends and relax is a solution that allows you to experience the home more freely.

In line with contemporary lifestyles, this solution integrates the kitchen and living area to create a new design language

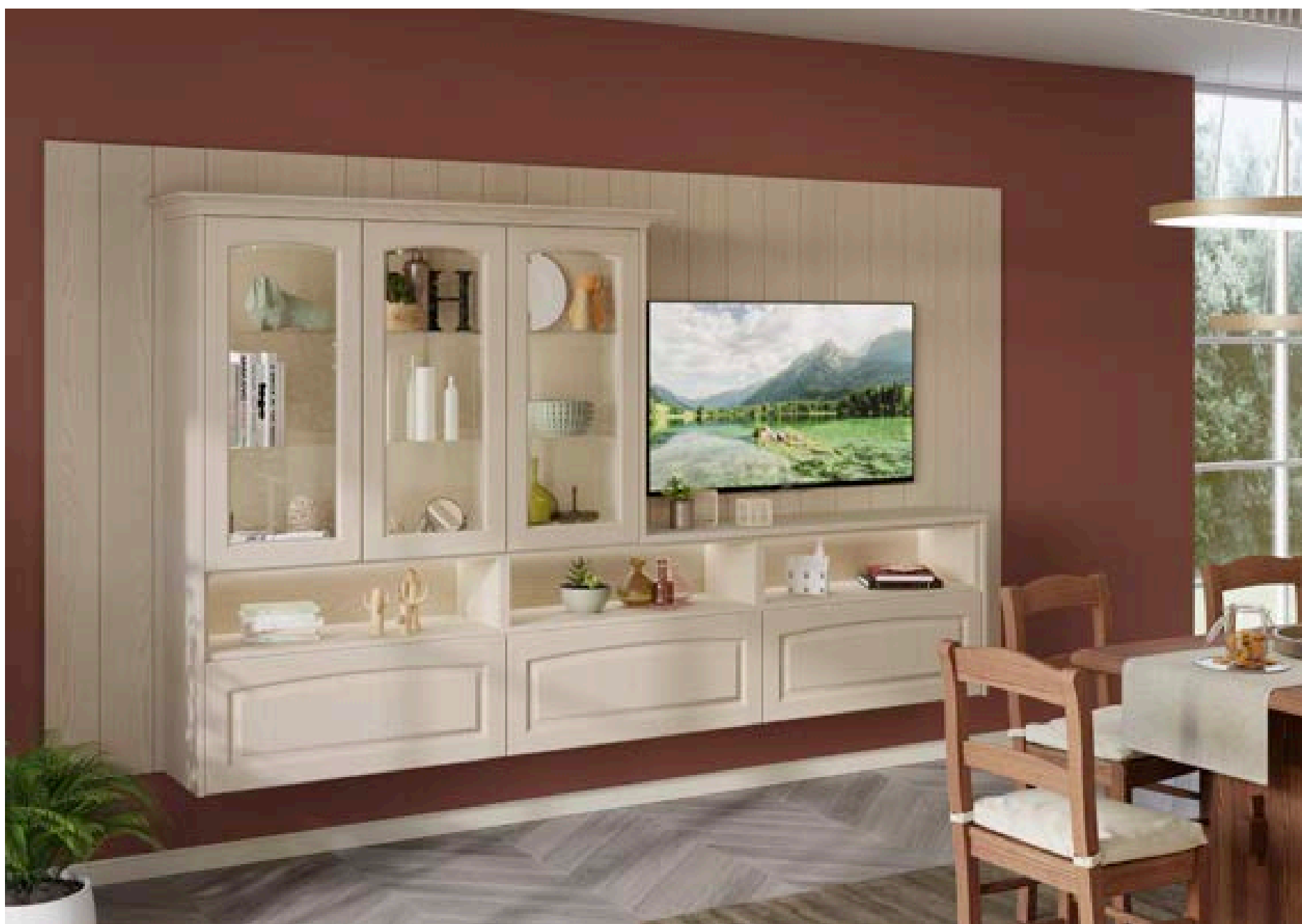

LIVING KGR1



ANTA
door



ELEMENTI A GIORNO
open units



STRUTTURA
carcass



NR. ELEMENTI	DESCRIZIONE	CODICE
3	Pensile L 45 H 96 P 33,2 anta e ripiano vetro, apertura push-pull	E1020451/2
3	Pensile L 90 H 36 P 33,2 vasistas, apertura push-pull	E2106900
3	Pensile L 90 H 24 P 31 a giorno impiallacciato come anta	E7901900
3	Profilo led mini noor dualcolor L 863	08618335
1	Alimentatore Mec Driver	08618002
1	Distributor	08618025
1	Cavo alimentazione Mec Driver	08618021
1	Top L 135,1 H 2 P 33,2 impiallacciato come anta	al ml TIL202
1	Fianco H 156+96+60 SP.2 P 33,2 impiallacciato come anta	al ml TIL202F
1	Cornice cappello L 224,6	al ml 093010
5	Asta appendipensili ml 2	08610501
	senza schienale	TOTALE
1	Schienale dogato L 330 H 180 SP.1,8 impiallacciato come anta	al mq 094341
	con schienale	TOTALE
No. of ELEMENTS	DESCRIPTION	CODE
3	Wall unit W 45 H 96 D 33,2 with glass door and shelf, push-pull opening	E1020451/2
3	Wall unit W 90 H 36 D 33,2 flap door with push-pull opening	E2106900
3	Veneered open wall unit W 90 H 24 D 31 same as door	E7901900
3	Mini noor lead profile dualcolor W 863	08618335
1	Power supply module Mec Driver	08618002
1	Distributor	08618025
1	Power cable Mec Driver	08618021
1	Veneered worktop W 135,1 H 2 D 33,2 same colour as door	per lm TIL202
1	Veneered side H 156+96+60 TH.2 D 33,2 same as door	per lm TIL202F
1	Top frame W 224,6	per lm 093010
5	Wall unit fixing strip lm 2	08610501
	with out back panel	TOTAL
1	Veneered striped back panel W 330 H 180 TH.1,8 same as door	per m ² 094341
	with back panel	TOTAL

LIVING KGR2



ANTA
door



ELEMENTI TRASFORMABILI
GENIUS-K
transformable elements
genius-k



STRUTTURA
carcass

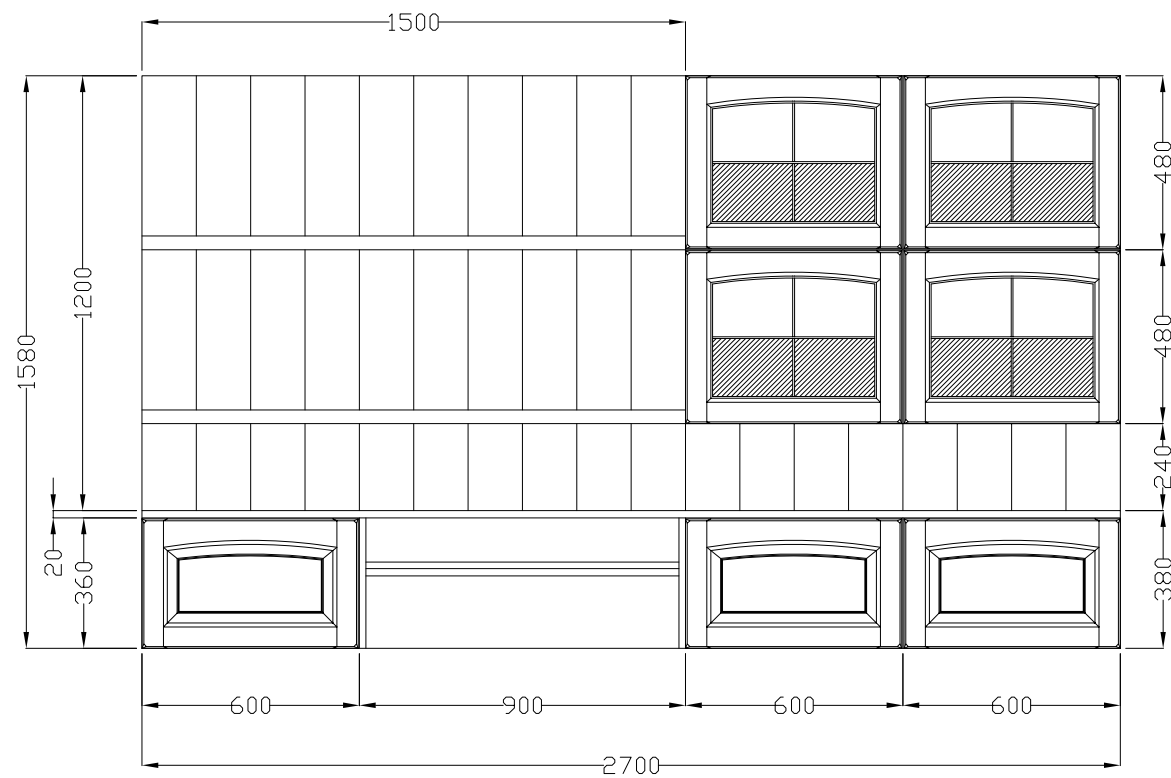
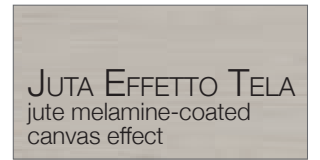

NR. ELEMENTI	DESCRIZIONE	CODICE
2	Pensile L 60 H 48 P 33,2 anta e ripiano vetro, 1 fianco come anta	E1040601/2
2	Pensile L 60 H 48 P 33,2 anta e ripiano vetro	E1040601/2
4	Faretto Sunrise 58	08618081
2	Base living sospesa L 60 H 36 P 50,2 cestone, fianco come anta	EBL75600
1	Base living sospesa L 60 H 36 P 50,2 cestone	EBL75600
1	Base SKIP-S L 90 H 36 P 48	EBL27209
1	Top living L 150+120 P 50,2 SP. 2 impiallacciato come anta	al ml TIL2055
2	Mensola L 150 H 3,8 P 31 impiallacciato come anta	al ml 091723
4	Reggimensola a scomparsa	08610400
2	Profilo led mini noor dualcolor L 146	08618285
1	Alimentatore Mec Driver	08618003
1	Distributore	08618025
1	Cavo alimentazione Mec Driver	08618021
2	Asta appendipensili ml 2	08610501
senza schienale		TOTALE
1	Schienale dogato L 150 H 120 SP.2 impiallacciato come anta	al mq 094341
1	Schienale dogato L 120 H 24 SP.2 impiallacciato come anta	al mq 094341
con schienale		TOTALE
No. of ELEMENTS	DESCRIPTION	CODE
2	Wall unit W 60 H 48 D 33,2 with glass door and shelf, side same as door	E1040601/2
2	Wall unit W 60 H 48 D 33,2 with glass door and shelf	E1040601/2
4	Sunrise 58 spotlight	08618081
2	Hanging living base unit W 60 H 36 D 50,2 deep drawer, side same as door	EBL75600
1	Hanging living base unit W 60 H 36 D 50,2 deep drawer	EBL75600
1	SKIP-S base unit W 90 H 36 D 48	EBL27209
1	Veneered living worktop W 150+120 D 50,2 TH.2 same colour as door	per lm TIL2055
2	Veneered shelf H 150 H 3,8 D 31 same colour as door	per lm 091723
4	Fully integrated shelf bracket	08610400
2	Mini noor lead profile dualcolor W 146	08618285
1	Power supply module Mec Driver	08618003
1	Distributor	08618025
1	Power cable Mec Driver	08618021
2	Wall unit fixing strip lm 2	08610501
with out back panel		TOTAL
1	Veneered striped back panel W 150 H 120 TH.2 same colour as door	per m ² 094341
1	Veneered striped back panel W 120 H 24 TH.2 same colour as door	per m ² 094341
with back panel		TOTAL

LIVING KGR3



ANTA
door

FRASSINO
GRIGIO REALE
royal grey ash

STRUTTURA
carcass

GRIGIO EFFETTO TELA
grey melamine-coated
canvas effect

LIVING KGR3

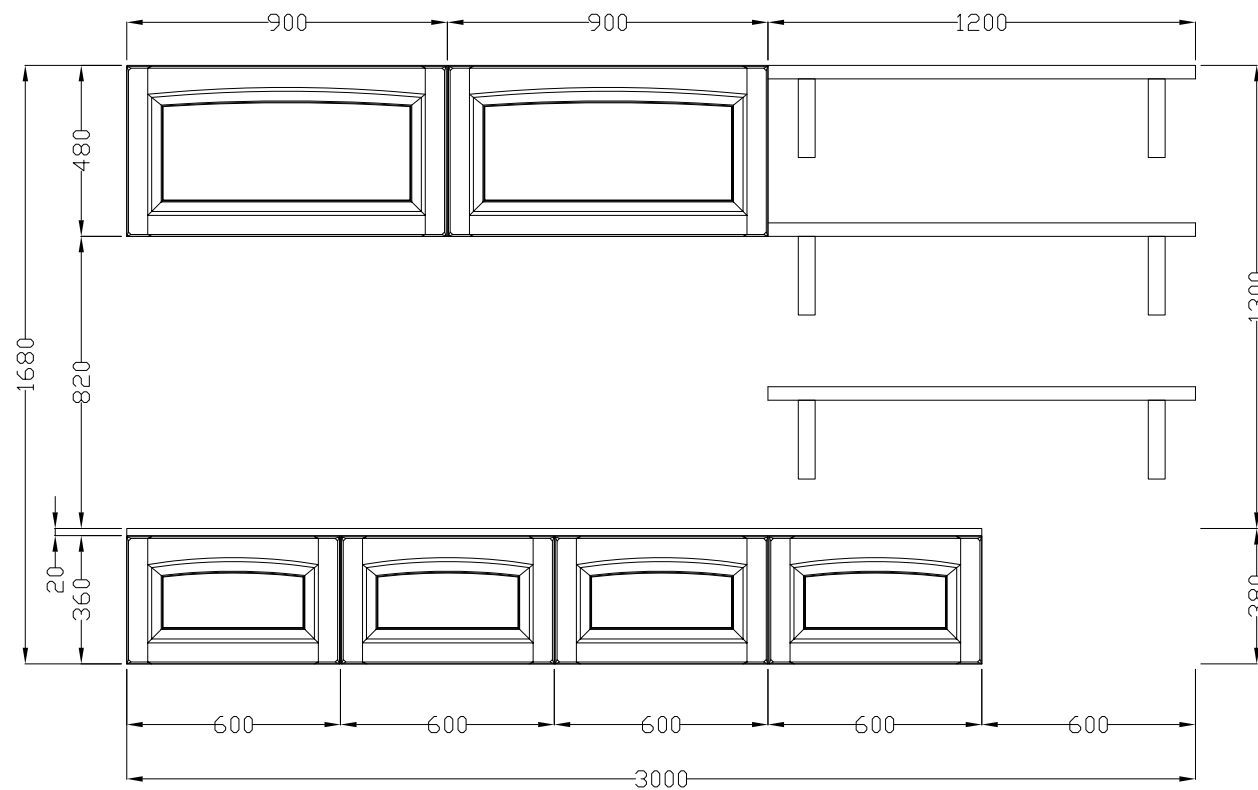

NR. ELEMENTI	DESCRIZIONE	CODICE
2	Pensile L 90 H 48 P 33,2 apertura tip-on, fianco come anta	E212091T
2	Base living sospesa L 60 H 36 P 50,2 cestone, fianco come anta	EBL25600
2	Base living sospesa L 60 H 36 P 50,2 cestone	EBL25600
1	Top living L 240 P 50,2 SP. 2 impiallacciato come anta	al ml TIL2055
3	Mensola L 120 P 31 SP. 3,8 impiallacciato come anta	al ml 091723
6	Reggimensola Polygon grigio selce	08610452G
3	Luce Kendo dualcolor L 86	08618233
1	Alimentatore Mec Driver	08618002
1	Distributor	08618025
1	Cavo alimentazione Mec Driver	08618021
1	Asta appendipensili ml 2	08610501
TOTALE		
No. of ELEMENTS	DESCRIPTION	CODE
2	Wall unit W 90 H 48 D 33,2 tip-on opening side same as door	E212091T
2	Hanging living base unit W 60 H 36 D 50,2 deep drawer, side same as door	EBL25600
2	Hanging living base unit W 60 H 36 D 50,2 deep drawer	EBL25600
1	Veneered living worktop W 240 D 50,2 TH.2 same colour as door	per lm TIL2055
3	Veneered shelf H 120 D 31 TH.3,8 same colour as door	per lm 091723
6	Polygon shelf bracket flint grey	08610452G
3	Kendo light dualcolor W 86	08618233
1	Power supply module Mec Driver	08618002
1	Distributor	08618025
1	Power cable Mec Driver	08618021
1	Wall unit fixing strip lm 2	08610501
TOTAL		

COMPOSIZIONE BASSA L 255

LOW COMPOSITION W 255



COMPOSIZIONE BASSA L 300

LOW COMPOSITION W 300



COMPOSIZIONE BASSA L 255

LOW COMPOSITION W 255

COMPONENTI COMPONENTS

Colonna 60 H 219 frigo-freezer 315 classe F

60 cm column H 219 fridge-freezer 315 class "F"

Base 45 2 cassetti e cestone

45 cm base unit with 2 drawers and deep drawer

Base 60 forno statico inox con ventilazione tangenziale di raffreddamento

stainless steel static oven with orbital cooling ventilation 60 base unit

Piano cottura 60 4 gas inox con valvola di sicurezza

60 cm stainless steel hob with 4 gas burners with safety valve

Sottolavello 90

90 cm sink unit

Lavello ad incasso 86 x 50 1 vasca inox prelucidato

86x50 cm built-in sink with 1 stainless steel bowl

Pensile vetro 45 H 72

45 cm glass wall unit H 72

Cappa 60 aspirante estraibile H 63 1 motore

60 cm hood slide-out ducting H 63 1 motor

Scolapiatti 90 H 72

90 cm plate rack H 72

Top 195 P 61 in laminato H 4

195 cm laminate worktop D 61 H 4

Cornice cappello ml 3,71

3,71 lm top cornice

Asta appendipensili ml 2

2 lm wall unit fixing strip

(Elettrodomestici Beko)
(Beko appliances)

GRACE

Fascia A

Band A

Fascia B

Band B

COMPOSIZIONE BASSA L 300

LOW COMPOSITION W 300

COMPONENTI COMPONENTS

Colonna 60 H 219 frigo-freezer 315 classe F

60 cm column H 219 fridge-freezer 315 class "F"

Base 60 2 cassetti e cestone

60 cm base unit with 2 drawers and deep drawer

Base 60 forno statico inox con ventilazione tangenziale di raffreddamento

stainless steel static oven with orbital cooling ventilation 60 base unit

Piano cottura 60 4 gas inox con valvola di sicurezza

60 cm stainless steel hob with 4 gas burners with safety valve

Base 60

60 cm base unit

Sottolavello 60

60 cm sink unit

Lavello ad incasso 86 x 50 1 vasca inox prelucidato

86x50 cm built-in sink with 1 stainless steel bowl

Pensile 60 H 72

60 cm wall unit H 72

Cappa 60 aspirante estraibile H 63 1 motore

60 cm hood slide-out ducting H 63 1 motor

Pensile 60 H 72

60 cm wall unit H 72

Scolapiatti 60 H 72

60 cm plate rack H 72

Top 240 P 61 in laminato H 4

240 cm laminate worktop D 61 H 4

Cornice cappello ml 4,16

4,16 lm top cornice

Asta appendipensili ml 4

4 lm wall unit fixing strip

(Elettrodomestici Beko)
(Beko appliances)

GRACE

Fascia A

Band A

Fascia B

Band B

COMPOSIZIONE ALTA L 300

HIGH COMPOSITION W 300



COMPOSIZIONE BASSA L 360

LOW COMPOSITION W 360



COMPOSIZIONE ALTA L 300

HIGH COMPOSITION W 300

COMPONENTI COMPONENTS

GRACE

Colonna 60 H 243 frigo-freezer 315 classe F

60 cm column H 243 fridge-freezer 315 class "F"

Base 60 2 cassetti e cestone

60 cm base unit with 2 drawers and deep drawer

Base 60 forno statico inox con ventilazione tangenziale di raffreddamento

stainless steel oven with orbital cooling ventilation 60 base unit

Piano cottura 60 4 gas inox con valvola di sicurezza

60 cm stainless steel hob with 4 gas burners with safety valve

Base 60

60 cm base unit

Sottolavello 60

60 cm sink unit

Lavello ad incasso 86 x 50 1 vasca inox prelucidato

86x50 cm built-in sink with 1 stainless steel bowl

Pensile 60 H 72

60 cm wall unit H 72

Cappa 60 aspirante estraibile H 63 1 motore

60 cm hood slide-out ducting H 63 1 motor

Pensile 60 H 96

60 cm wall unit H 96

Scolapiatti 60 H 96

60 cm plate rack H 96

Top 240 P 61 in laminato H 4

240 cm laminate worktop D 61 H 4

Mensola 120 P 31 sp. 3,8

120 cm shelf D 31 sp. 3,8

Cornice cappello ml 4,16

4,16 lm top cornice

Asta appendipensili ml 4

4 lm wall unit fixing strip

(Elettrodomestici Beko)

(Beko appliances)

Fascia A

Band A

Fascia B

Band B

COMPOSIZIONE BASSA L 360

LOW COMPOSITION W 360

COMPONENTI COMPONENTS

GRACE

Colonna 60 H 219 frigo-freezer 315 classe F

60 cm column H 219 fridge-freezer 315 class "F"

Colonna 60 H 111 con cestone, forno statico inox con ventilazione tangenziale di raffreddamento

60 column H.111 with deep drawer configured for stainless steel static oven with orbital cooling ventilation

Base 90 2 cassetti + cestone predisposto P.C.

90 cm base unit with 2 drawers + deep drawer configured for hob

Piano cottura 60 4 gas inox con valvola di sicurezza

60 cm stainless steel hob with 4 gas burners with safety valve

Base 60

60 cm base unit

Sottolavello 90

90 cm sink unit

Lavello ad incasso 86 x 50 1 vasca inox prelucidato

86x50 cm built-in sink with 1 stainless steel bowl

Pensile 60 H 72

60 cm wall unit H 72

Cappa 90 caminetto tipo "E"

90 chimney hood type "E"

Pensile 60 H 72

60 cm wall unit H 72

Scolapiatti 90 H 72

90 cm plate rack H 72

Top 240 P 61 in laminato H 4

240 cm laminate worktop D 61 H 4

Top 60 P 61 in laminato H 4

60 cm laminate worktop D 61 H 4

Mensola 90 P 31 SP 3,8

90 cm shelf D 31 SP 3,8

Cornice cappello ml 4,76

4,76 lm top cornice

Asta appendipensili ml 4

4 lm wall unit fixing strip

(Elettrodomestici Beko)

(Beko appliances)

Fascia A

Band A

Fascia B

Band B