

Living

DIVANI E
POLTRONE
SOFAS AND
ARMCHAIRS

BONALDO

ITALIER

Living

DIVANI E
POLTRONE
SOFAS AND
ARMCHAIRS

BONALDO

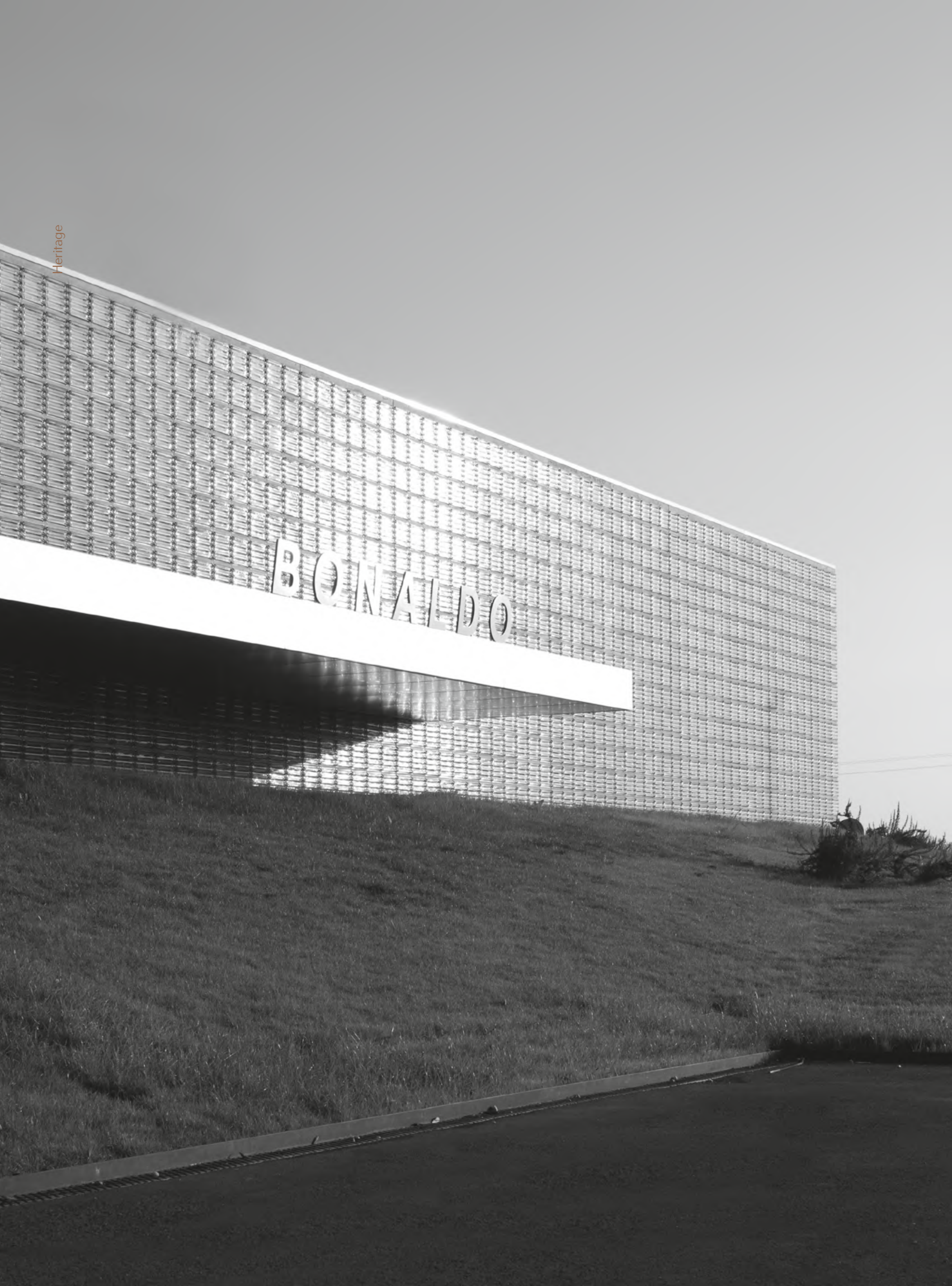

Heritage

The Bonaldo story

The Bonaldo story is one of the here and now which spans generations and designs, needs and desires, interpreting the unpredictability of time as an opportunity and regarding consistency as a constantly evolving process. From 1936, the year in which Giovanni Vittorio Bonaldo began working metals, and which represents this mythical entrepreneurial “starting point” certain distinctive characteristics can already be detected. These would remain over time, maintaining and renewing themselves in the interpretations of styles and demands of design and the different eras. These traits derived from a deeply rooted relationship between man and matter and are the basis of the very idea of living.

La storia di Bonaldo è una storia del presente, che attraversa generazioni e progetti, bisogni e desideri, interpretando le imprevedibilità del tempo come un’opportunità e la coerenza come un processo in continua evoluzione. Nel 1936, anno in cui Giovanni Vittorio Bonaldo inizia a lavorare metalli, mitico “punto di partenza” imprenditoriale, si possono scorgere tratti distintivi che proseguiranno nel tempo, mantenendosi e rinnovandosi nelle interpretazioni degli stili e delle esigenze, nel design e nelle tecnologie. Tratti derivati da un rapporto profondo tra l’uomo e la materia, che stanno alla base dell’idea stessa di abitare.

Negli anni, Bonaldo evolve il proprio originario spirito artigianale attraverso un articolato percorso industriale, che interpreta l'innovazione per il design come un processo d'insieme, e non come un semplice rinnovamento tecnologico.

Over the years, the original spirit behind Bonaldo's handcrafted work has evolved and matured following a well trodden path in which design innovation is interpreted as a comprehensive overall process and not simple technological renewal.



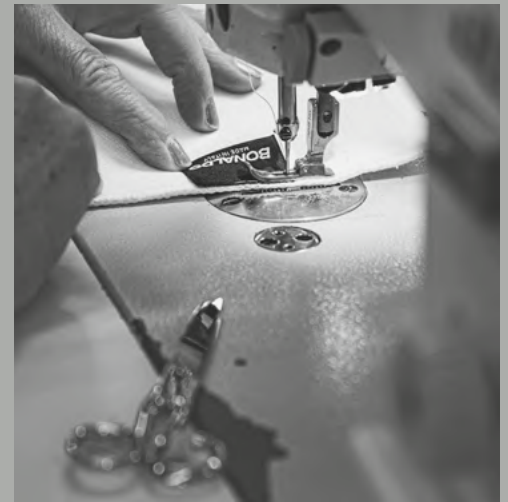
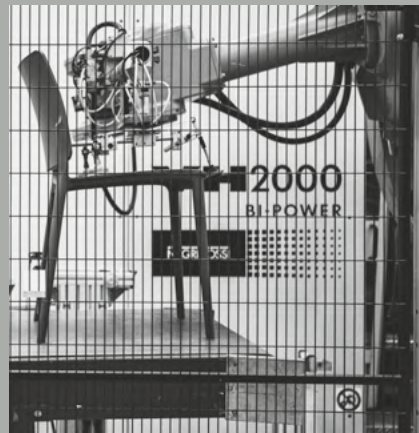
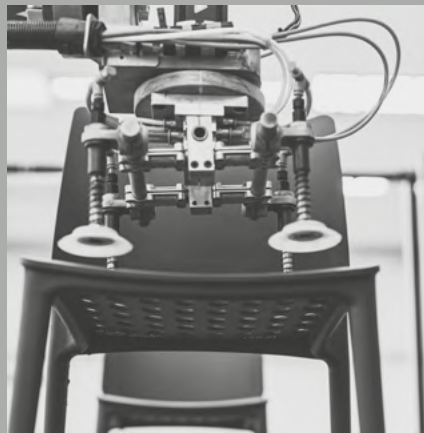
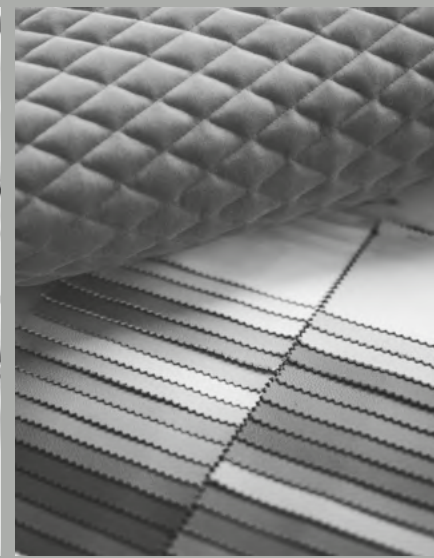
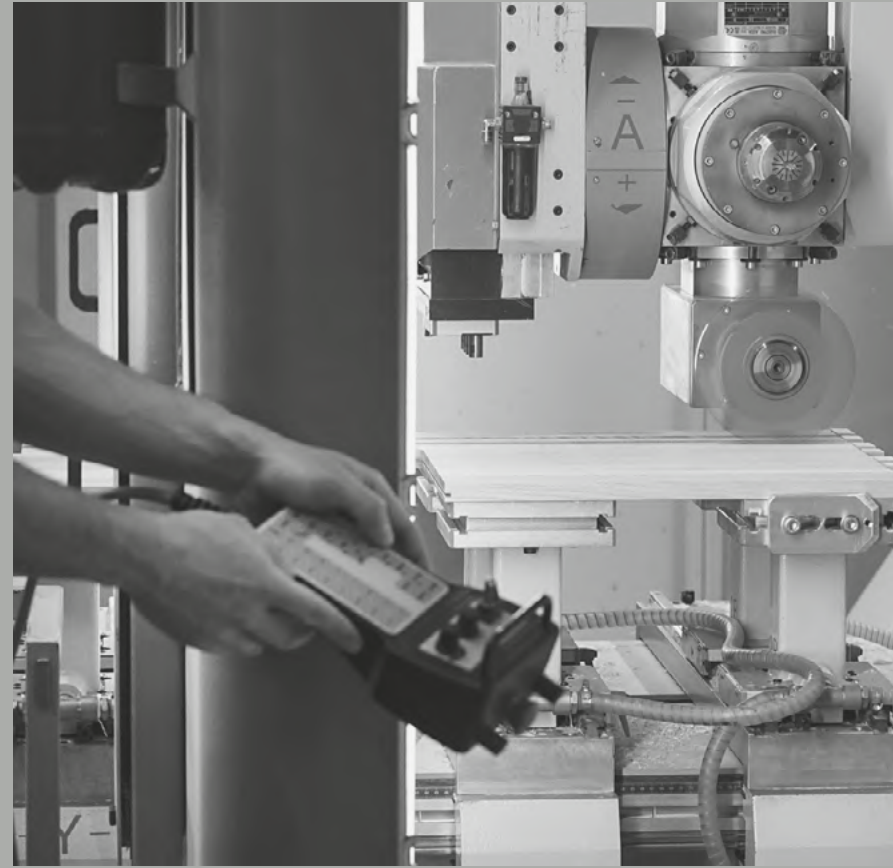

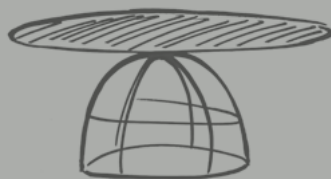
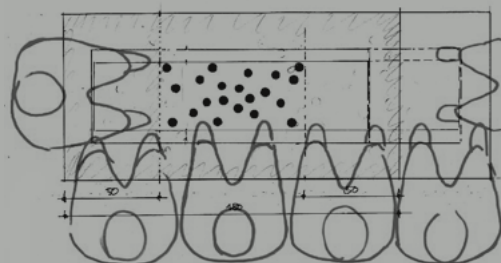
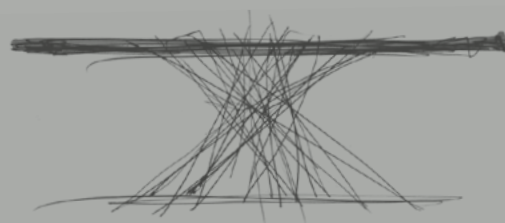
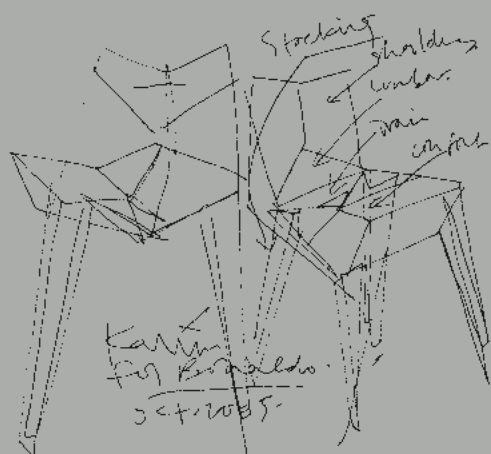

Interpreti internazionali del design, dalle personalità diverse e ben caratterizzate, gli autori Bonaldo intrecciano le loro storie interagendo in maniera trasversale nella costruzione di un progetto complessivo e sfaccettato.

International interpreters of design, all with different yet well-defined personalities, Bonaldo's creative professionals tell their stories by interacting in an individual yet complementary way, working together to construct a multifaceted overall design project.

Bonaldo e il design

Il profilo di un brand viene definito da una complessa alchimia tra ricerca e sviluppo, visioni imprenditoriali, talenti espressivi, che prende corpo nelle soluzioni custodite tra le pieghe di ogni progetto.

Nel corso dei suoi più di ottant'anni di storia, Bonaldo ha intrecciato la sua strada con quella di quasi trenta designer, orchestrandone le varie poetiche in uno stile armonico e coerente, che permette di percepire nell'insieme qualcosa che va oltre la loro semplice somma.

Bonaldo and design A brand's profile is defined by a complex alchemy resulting from research and development, entrepreneurial visions and expressive talents and which can be seen in the solutions woven into the fabric of each design. Over the course of its more than eighty years of history, Bonaldo's business has grown hand in hand with the work of almost thirty designers whose independent contributions have been brought together in a harmonious and coherent style which allows us to perceive as a whole something that goes beyond the sum of its various individual parts.

Nata come manifattura dei metalli, la storia di Bonaldo si estende negli anni attraverso il confronto con i materiali e le tecniche di produzione: dalle lavorazioni in legno o in ceramica alla produzione di oggetti in policarbonato o in pressofusione in alluminio; dalle applicazioni del vetro, del cuoio o dei tessuti a quelle in marmo, cemento o argilla.

Bonaldo: materials and products
Originally established as a manufacturer of metal products, over the years Bonaldo has expanded to include other materials and production techniques. These range from ceramics and woodworking to the production of polycarbonate and die-cast aluminium objects as well as applications using glass, leather, fabrics, marble, concrete and clay.



Bonaldo worldwide

From Moscow to Shenzhen and from Casablanca to Miami, Bonaldo's vision takes in cities and landscapes all over the world, crossing the boundaries between cultures and sensibilities with the same lightness with which it spans space and time. Its message conveys a global design which catches the eye as it sets new standards in emotions.

Da Mosca a Shenzhen, da Casablanca a Miami: la visione di Bonaldo attraversa le città e i paesaggi del mondo, oltrepassando i confini tra le culture e le sensibilità con la stessa leggerezza con cui attraversa lo spazio e il tempo. Il suo messaggio trasmette un design globale, che cattura lo sguardo mentre stabilisce un avamposto nelle emozioni.

WWW.BONALDO.COM



Indice/Index

HERITAGE p. 01

PRODOTTI. PRODUCTS. p. 18

DATI TECNICI. TECHNICAL DATA. p. 405

CAMPIONI MATERIALI. MATERIAL SAMPLES. p. 465

DIVANI. SOFAS.

Aliante
p. 94



Blend
p. 110



Bonamour
p. 44



Ever More
p. 152



Lars
p. 222



Liam
p. 22



Lovy hi, Lovy low
p. 244



Maximilian
p. 78



Panorama New
p.170



Paraiso
p. 196



Peanut B., Peanut B.X.
p. 122



Phil
p. 62



Saddle
p. 212



Skid
p. 232



Soft Island
p. 182



Superhiro
p. 260



POLTRONE. ARMCHAIRS.

Alpilles
p. 330



Bodo
p. 350



Bruno
p. 346



Colibri
p. 340



Cross lounge chair
p. 278



Globalove
p. 334



Kitai
p. 284



Lock
p. 318



Lovy armchair
p. 324



Neuilly lounge
p. 308



Nikos
p. 354



Noor lounge
p. 314



Olos, Olos bergère
p. 290



Pil armchair
p. 358



Saddle armchair
p. 362



Sleek
p. 302



Tirella, Tirella sofa
p. 366



POUF. POUFS.

Belt & Cross
p. 378



Clessidra
p. 394



Intrecci
p. 402



Lovy pouf
p. 386



Mark
p. 398



Neuilly pouf
p. 382



Olos pouf
p. 374



Seki
p. 390



Il living è per Bonaldo uno spazio pulsante, che vive in ogni momento della giornata, offrendo comfort, accoglienza e libertà di movimento ai corpi, ai gesti, e alle interazioni tra persone, attitudini, stili e atmosfere. In ogni divano si respira una visione armonica del design, che va oltre la semplice somma delle singole qualità degli oggetti, delle loro forme armoniche, delle dimensioni generose, dei materiali ricercati, delle finiture preziose. Un'interazione profonda tra scelte stilistiche e lavorazioni esperte che trasforma tutte le forme del living in elementi integranti dell'ambiente e della vita contemporanea.

For Bonaldo the living room is a vibrant space, full of life in every moment of the day, offering comfort, hospitality and freedom of movement to bodies, gestures, and interactions between people, attitudes, styles and atmospheres. Each sofa exudes a harmonious vision of design which goes beyond the simple sum of the individual qualities of the objects, their synergistic shapes, generous dimensions, elegant materials and valuable finishes. There is a profound interaction between stylistic choices and expert workmanship that transforms all the shapes in each living room into integral elements of the surrounding environment and contemporary life.

divani/sofas

DIVANI / SOFAS

ALIANTE	P. 94
BLEND	P. 110
BONAMOUR	P. 44
EVER MORE	P. 152
LARS	P. 222
LIAM	P. 22
LOVY HI, LOVY LOW	P. 244
MAXIMILIAN	P. 78
PANORAMA NEW	P. 170
PARAISO	P. 196
PEANUT B. , PEANUT B.X.	P. 122
PHIL	P. 62
SADDLE	P. 212
SKID	P. 232
SOFT ISLAND	P. 182
SUPERHIRO	P. 260

Liam

Design Sergio Bicego

Rigoroso ed essenziale nell'impronta formale, basata su geometrie primarie, il divano Liam fa della versatilità funzionale e dell'ergonomia di utilizzo il proprio elemento caratterizzante. L'ampio programma di imbottiti disegnato da Sergio Bicego comprende elementi integrabili tra loro, che ne estendono le possibilità di inserimento nello spazio. Armonizzandosi con gli altri complementi d'arredo, Liam può dare vita a innumerevoli configurazioni di interior design per interpretare gli stili più disparati del living contemporaneo, sia della casa sia nei contesti dell'hospitality e delle zone di rappresentanza.

Liam è proposto sia in versione lineare, sia con elementi inclinati per creare spazi ancora più definiti e raccolti.

With a rigorous, formal and essential style based on primary geometric shapes, the Liam sofa makes functional versatility and ergonomics of use its outstanding characteristics. The extensive range of upholstered furniture designed by Sergio Bicego includes elements that can be integrated with each other, thereby extending the possibilities for insertion into different spaces. By harmonizing with other furnishing accessories, Liam is able to create countless interior design configurations for interpreting the most disparate styles of contemporary living, both in the home, hospitality contexts and reception areas.

Liam is available both in a linear version and with curved elements to create even more defined and intimate spaces.

LIAM divano/sofa
design Sergio Bicego

ELEMENT tavolino/coffee table
design Alain Gilles

VAGUE MIRROR specchio/mirror
design Roberto Paoli



LIAM divano/sofa
design Sergio Bicego

ELEMENT tavolino/coffee table
design Alain Gilles

BIO-S lampada da terra/floor lamp
Studio Team Design

BACKDROP credenza/sideboard
design Alain Gilles

PASSY tavolino/coffee table
design Fabrice Berrux



LIAM divano/sofa
design Sergio Bicego

ELEMENT tavolino/coffee table
design Alain Gilles



LIAM divano/sofa
design Sergio Bicego

BIO-S lampada da terra/floor lamp
Studio Team Design



LIAM divano/sofa
design Sergio Bicego

ELEMENT tavolino/coffee table
design Alain Gilles

PIN lampada da terra/floor lamp
design Dondoli e Poggi

KASUMI tavolino/coffee table
design Toshiyuki Yoshino

SCULPTURAL porta TV/TV stand
design Alain Gilles

CROSS LOUNGE CHAIR poltrona/armchair
design Alain Gilles



LIAM divano/sofa
design Sergio Bicego



Divani, Sofas.

LIAM divano/sofa
design Sergio Bicego

KASUMI tavolino/coffee table
design Toshiyuki Yoshino

WAVE paravento/screen
design Marconato & Zappa

ELEMENT tavolino/coffee table
design Alain Gilles

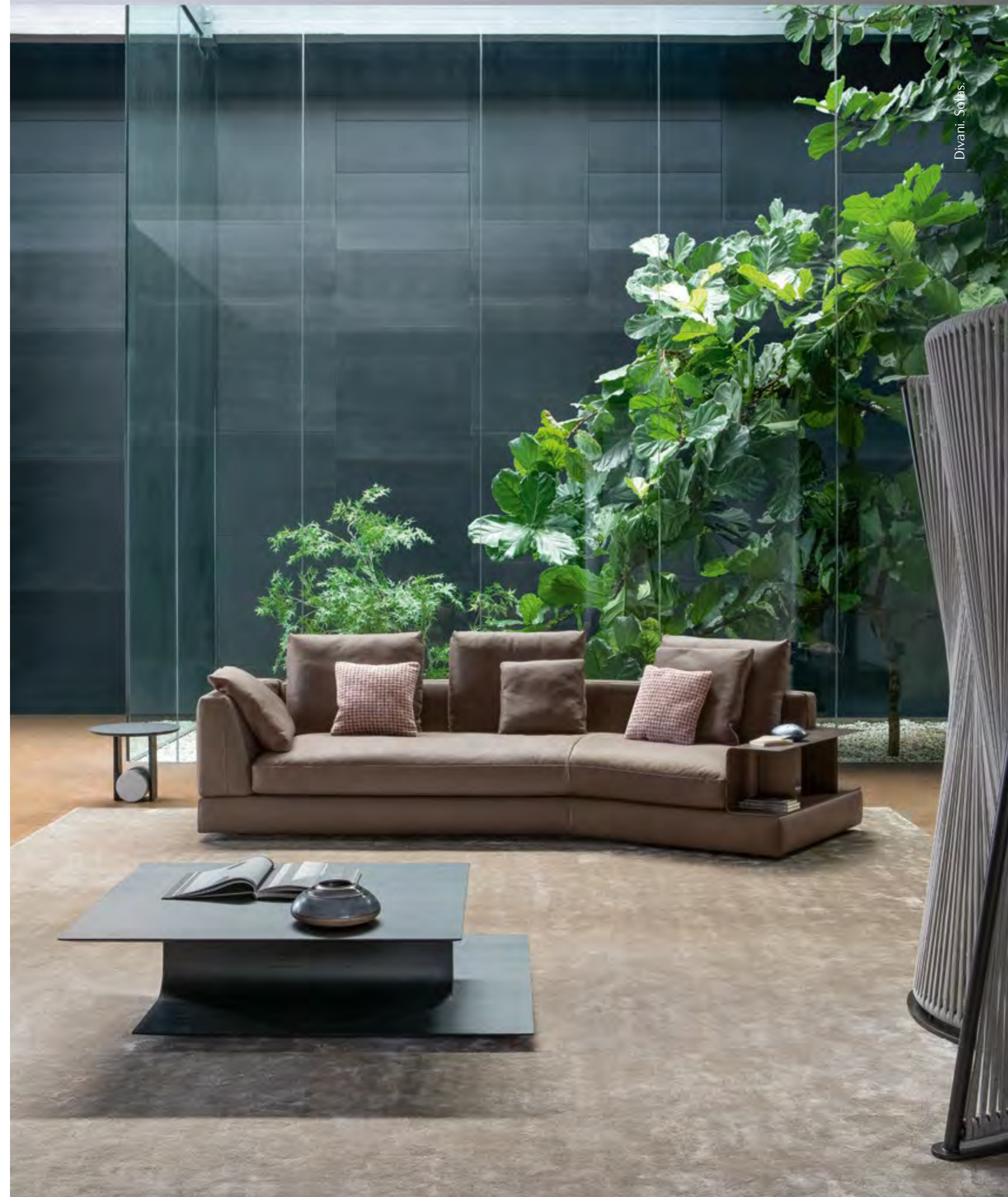

Divani, Sofas.

Il divano è realizzato con cura sartoriale in ogni dettaglio, come il piede in metallo verniciato, il bracciolo porta riviste e il tavolino-vassoio in cuoio, proposti in ricercate varianti cromatiche.

The sofa is produced with sartorial care in every detail, such as the painted metal feet, the magazine holder armrest and the leather tray table, offered in a range of sophisticated colours.

LIAM divano/sofa
design Sergio Bicego

VAGUE porta riviste/magazine rack
design Roberto Paoli

DOGMA libreria/bookshelf
design Alain Gilles

PADDLE tavolino/coffee table
design Mauro Lipparini

PIN lampada da terra/floor lamp
design Dondoli e Poggi



LIAM divano/sofa
design Sergio Bicego

VAGUE porta riviste/magazine rack
design Roberto Paoli

PADDLE tavolino/coffee table
design Mauro Lipparini

KITAI poltrona/armchair
design Marconato & Zappa

DOGMA libreria/bookshelf
design Alain Gilles

PIN lampada da terra/floor lamp
design Dondoli e Poggi



LIAM divano/sofa
design Sergio Bicego

PADDLE tavolino/coffee table
design Mauro Lipparini



Divani, Sofas.

LIAM divano/sofa
design Sergio Bicego

VAGUE porta riviste/magazine rack
design Roberto Paoli

DOGMA libreria/bookshelf
design Alain Gilles



Divani, Sofas.

Liam è dotato di un rivestimento completamente sfoderabile in pelle, ecopelle e tessuto e in questa ultima versione è disponibile, su richiesta, anche un bordo ornamentale.

Liam comes with a completely removable cover in leather, eco-leather or fabric and in this latest version, a decorative border is also available on request.

LIAM divano/sofa
design Sergio Bicego

KAOS libreria/bookshelf
design Mauro Lipparini

KUMO tavolino/coffee table
design Mauro Lipparini



LIAM divano/sofa
design Sergio Bicego

KAOS libreria/bookshelf
design Mauro Lipparini

KUMO tavolino/coffee table
design Mauro Lipparini

PIN lampada da terra/floor lamp
design Dondoli e Pocci

40
/ 41

Divani, Sofas.

Divani, Sofas.



LIAM divano/sofa
design Sergio Bicego



Divani, Sofas.

LIAM divano/sofa
design Sergio Bicego

KAOS libreria/bookshelf
design Mauro Lipparini

KUMO tavolino/coffee table
design Mauro Lipparini



Divani, Sofas.

Bonamour

Design Mauro Lipparini

L'atmosfera conviviale e il design geometrico e informale rivivono nel design di Bonamour in un'originale e ricercata interpretazione contemporanea. La famiglia di imbottiti comprende un sistema di sedute, braccioli e schienali dalla morfologia essenziale: moduli rettangolari o quadrati, di varie dimensioni, studiati per interagire liberamente tra loro e così dare vita a innumerevoli configurazioni e volumetrie lineari e angolari. A far da contrasto all'impronta formale, i dettagli ricercati, come le pinces che attraversano la superficie dei rivestimenti e scandiscono il ritmo delle sedute e degli schienali.

A convivial atmosphere and a geometric and informal pattern come to life in Bonamour's design in an original and sophisticated contemporary interpretation. The family of upholstered furniture includes a system of seats, armrests and backrests with a minimalist format: rectangular or square modules of various sizes are designed to interact freely with each other and thus give life to countless linear and angular configurations and volumes. The formal style contrasts with the elegant details such as the pleats that cross the surface of the coverings and highlight the rhythm of the seats and backrests.

BONAMOUR divano/sofa
design Mauro Lipparini

PADDLE tavolino/coffee table
design Mauro Lipparini

KUMO tavolino/coffee table
design Mauro Lipparini

44 /
45



BONAMOUR divano/sofa
design Mauro Lipparini

PADDLE tavolino/coffee table
design Mauro Lipparini

KUMO tavolino/coffee table
design Mauro Lipparini

PIN lampada da terra/floor lamp
design Dondoli e Pocci

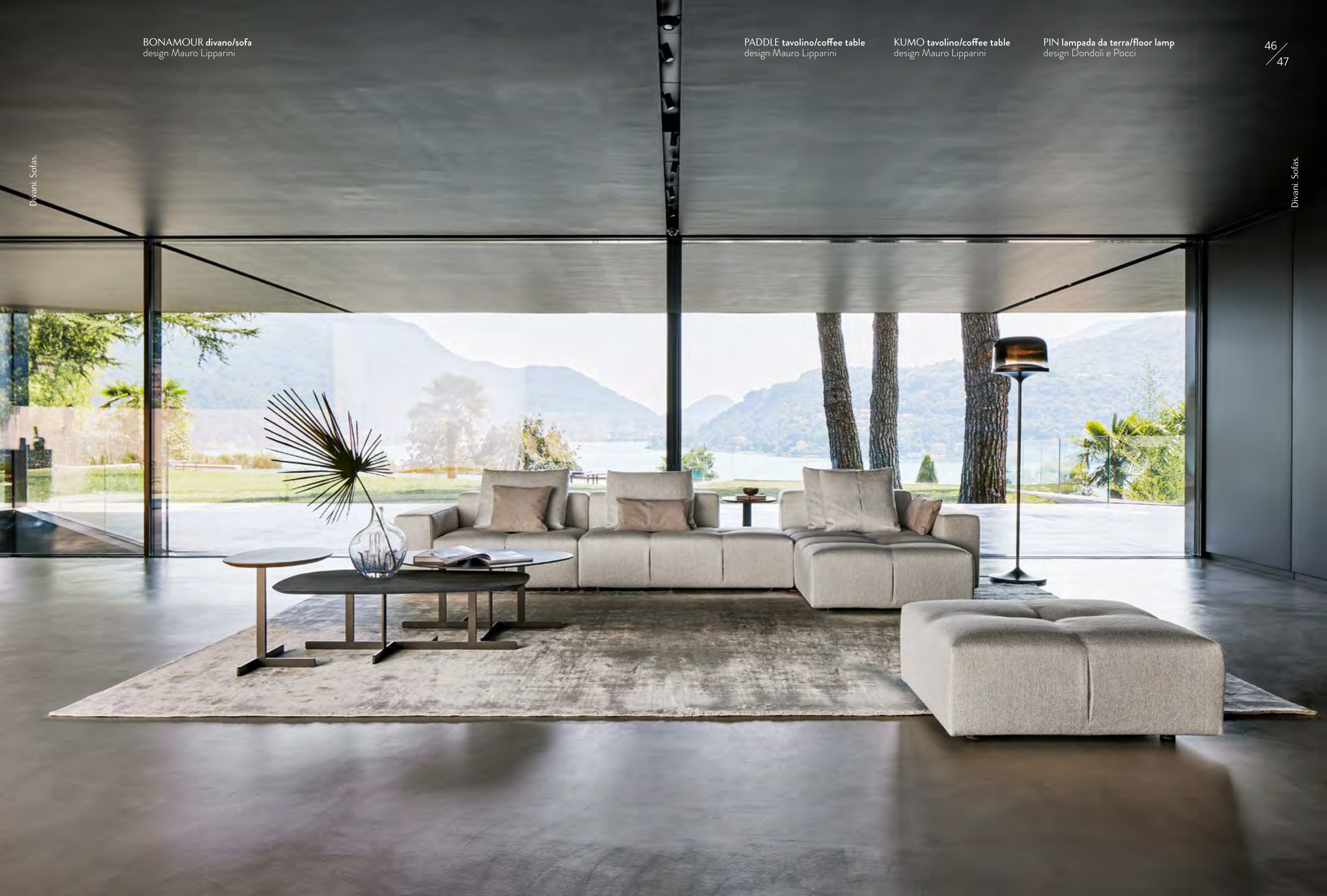

BONAMOUR divano/sofa
design Mauro Lipparini

PADDLE tavolino/coffee table
design Mauro Lipparini



BONAMOUR divano/sofa
design Mauro Lipparini



BONAMOUR divano/sofa
design Mauro Lipparini

OLOS poltrona/armchair
design Mauro Lipparini

KUMO tavolino/coffee table
design Mauro Lipparini

PADDLE tavolino/coffee table
design Mauro Lipparini

PIN lampada da terra/floor lamp
design Dondoli e Pucci

BACKDROP credenza/sideboard
design Alain Gilles



BONAMOUR divano/sofa
design Mauro Lipparini

KAOS libreria/bookshelf
design Mauro Lipparini

PADDLE tavolino/coffee table
design Mauro Lipparini

JAZZ tavolino/coffee table
design Bonaldo Lab

PIN lampada da terra/floor lamp
design Dondoli e Pocci



BONAMOUR divano/sofa
design Mauro Lipparini

PADDLE TV STAND LIGHT porta TV/TV stand
design Mauro Lipparini

KAOS libreria/bookshelf
design Mauro Lipparini

PADDLE tavolino/coffee table
design Mauro Lipparini

PIN lampada da terra/floor lamp
design Dondoli e Pocci



BONAMOUR divano/sofa
design Mauro Lipparini

PADDLE tavolino/coffee table
design Mauro Lipparini

PADDLE TV STAND LIGHT porta TV/TV stand
design Mauro Lipparini

JAZZ tavolino/coffee table
design Bonaldo Lab



BONAMOUR divano/sofa
design Mauro Lipparini



Divani, Sofas.

BONAMOUR divano/sofa
design Mauro Lipparini

PADDLE TV STAND LIGHT porta TV/TV stand
design Mauro Lipparini



Divani, Sofas.

BONAMOUR divano/sofa
design Mauro Lipparini



Divani, Sofas.

BONAMOUR divano/sofa
design Mauro Lipparini

SLEEK poltrona/armchair
design Mauro Lipparini

DORIAN credenza/sideboard
design Spazioameno

JAZZ tavolino/coffee table
design Bonaldo Lab

BIO-S lampada da terra/floor lamp
Studio Team Design



Divani, Sofas.

Phil

Design Sergio Bicego

Divano versatile e generoso, Phil unisce la leggerezza della struttura con i volumi ampi delle parti imbottite. Se il comfort della seduta è garantito dall'imbottitura, il comfort visivo è offerto da dettagli come l'elegante base in metallo o il profilo ornamentale (un bordo in gros grain che può essere personalizzato con tonalità a contrasto o tono su tono), oppure con vari elementi aggiuntivi in cuoio: dai braccioli, ai braccioli porta riviste, fino ai vassoi coordinati. La famiglia Phil comprende due versioni: "Casual", con i cuscini dello schienale dalle dimensioni ridotte e distanziati tra loro, e "Linear", con i cuscini dello schienale adiacenti e di grandi dimensioni.

A versatile and generous sofa, Phil combines the lightness of its frame with the large volumes of its padded sections. If the physical comfort of the seat is guaranteed by the padding, visual comfort is catered for by details such as the elegant metal base or the decorative profile (a grosgrain border that can be customized with contrasting or tone-on-tone shades), or with various additional elements in leather from the armrests to the magazine holder armrests up to the coordinated trays. The Phil family includes two versions: "Casual", with smaller back cushions spaced apart, and "Linear", with the back cushions adjacent and larger in size.

PHIL divano/sofa
design Sergio Bicego

ROLL libreria/bookshelf
design Dondoli e Pucci

HARPE tavolino/coffee table
design Fabrice Berrux

62
/ 63



PHIL divano/sofa
design Sergio Bicego

HARPE tavolino/coffee table
design Fabrice Berrux

BIO-S lampada da terra/floor lamp
Studio Team Design

Divani, Sofas.

Divani, Sofas.



PHIL divano/sofa
design Sergio Bicego



Divani, Sofas.

PHIL divano/sofa
design Sergio Bicego



Divani, Sofas.

PHIL divano/sofa
design Sergio Bicego

ROLL libreria/bookshelf
design Dondoli e Pucci

HARPE tavolino/coffee table
design Fabrice Berrux



PHIL divano/sofa
design Sergio Bicego

FLAME CONSOLE consolle/console
design Gino Carollo

ROLL libreria/bookshelf
design Dondoli e Pucci

HARPE tavolino/coffee table
design Fabrice Berrux



PHIL divano/sofa
design Sergio Bicego

PASSY tavolino/coffee table
design Fabrice Berrux

PIN lampada da terra/floor lamp
design Dondoli e Pocci

L'eleganza del divano disegnato da Sergio Bicego emerge al primo sguardo: sia nelle soluzioni lineari, sia nelle configurazioni angolari, con le parti imbottite sospese dalla struttura metallica.

The elegance of the sofa designed by Sergio Bicego is clear at first glance, both in the linear solutions and in the angular configurations, with the padded parts suspended from the metal structure.



PHIL divano/sofa
design Sergio Bicego

DOGMA libreria/bookshelf
design Alain Gilles

PASSY tavolino/coffee table
design Fabrice Berrux

PIN lampada da terra/floor lamp
design Dondoli e Poggi



PHIL divano/sofa
design Sergio Bicego



Divani, Sofas.

PHIL divano/sofa
design Sergio Bicego

PASSY tavolino/coffee table
design Fabrice Berrux



Divani, Sofas.

Maximilian

Design Sergio Bicego

Elegante nel disegno e ricco nelle personalizzazioni, il divano Maximilian reinterpreta sul piano stilistico in chiave spiccatamente contemporanea e informale alcuni elementi classici del design anni Cinquanta. Ingrediente principale della ricetta compositiva: il gioco di forme, proporzioni e materiali che si stabilisce fra la lineare base d'appoggio metallica e gli ampi volumi imbottiti dei cuscini e dello schienale, attraversati da una trapuntatura continua e ritmata che costituisce un tema decorativo ben riconoscibile. Il programma è arricchito ulteriormente da vari accessori disponibili in cuoio, come il bracciolo, il bracciolo portariviste ed il tavolino coordinato.

Elegant in design and rich in personal touches, the Maximilian sofa stylistically reinterprets a number of classic 1950s design elements in a distinctly contemporary and informal key. The main ingredient of the compositional recipe is the interplay of shapes, proportions and materials that is established between the linear metal support base and the large padded volumes of the cushions and backrest with a continuous and rhythmic quilting that constitutes a clearly recognizable decorative theme. The collection is further enhanced by a range of accessories available in leather such as the armrest, the magazine rack armrest and the coordinated coffee table.

MAXIMILIAN divano/sofa
design Sergio Bicego

HARPE tavolino/coffee table
design Fabrice Berrux

PEAK tavolino/coffee table
design Mauro Lipparini

78
79



MAXIMILIAN divano/sofa
design Sergio Bicego

HARPE tavolino/coffee table
design Fabrice Berrux



Divani, Sofas.

MAXIMILIAN divano/sofa
design Sergio Bicego



Divani, Sofas.

MAXIMILIAN divano/sofa
design Sergio Bicego

ARPA libreria/bookshelf
design Codato e Trevisiol

PADDLE tavolino/coffee table
design Mauro Lipparini

BARDOT lampada da terra/floor lamp
design Laura Cazzaniga e Ilaria Limonta



MAXIMILIAN divano/sofa
design Sergio Bicego



Divani, Sofas.

MAXIMILIAN divano/sofa
design Sergio Bicego

PEAK tavolino/coffee table
design Mauro Lipparini

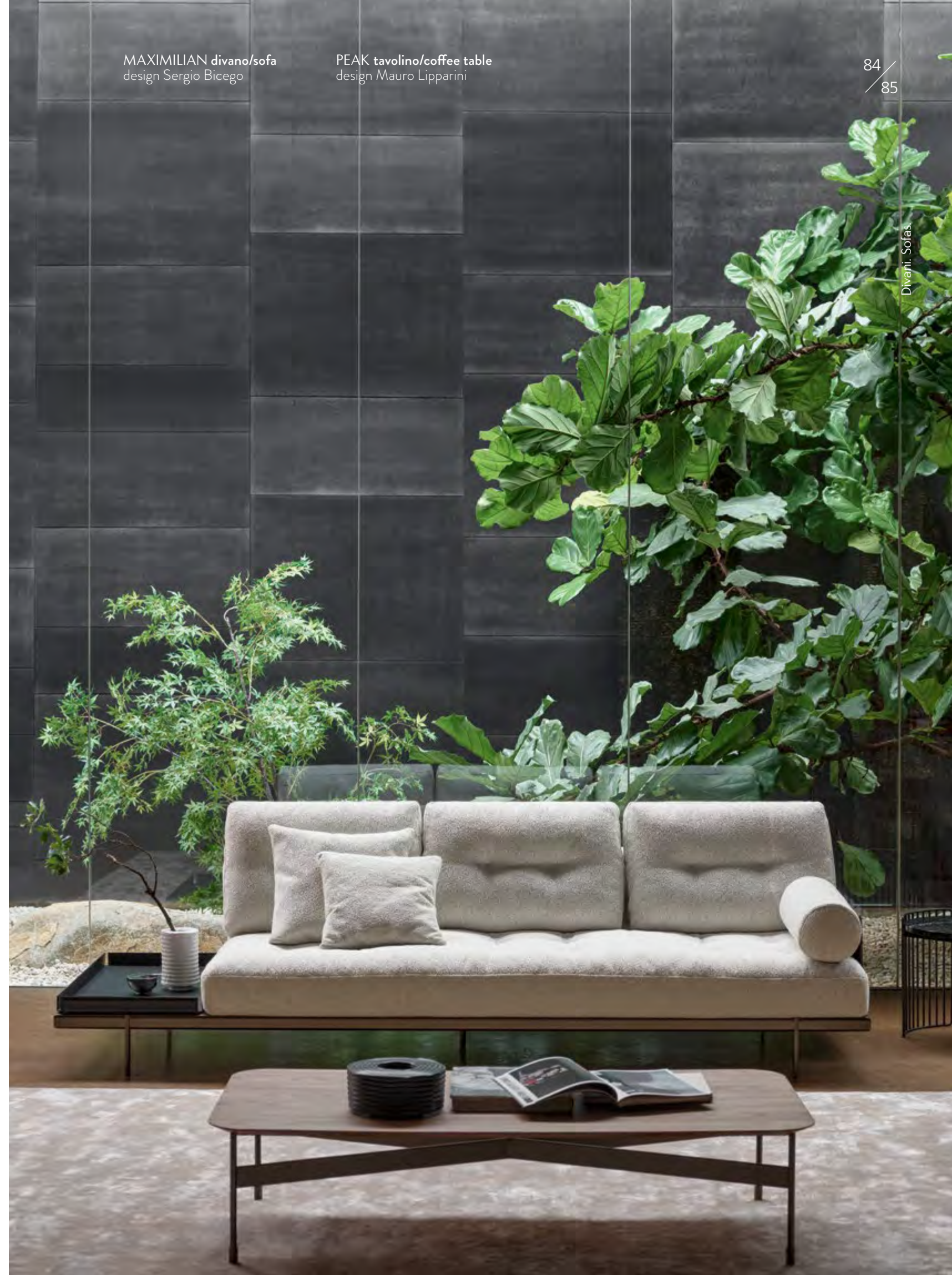

Divani, Sofas.

MAXIMILIAN divano/sofa
design Sergio Bicego



MAXIMILIAN divano/sofa
design Sergio Bicego

ARPA libreria/bookshelf
design Codato e Trevisiol

PADDLE tavolino/coffee table
design Mauro Lipparini



MAXIMILIAN divano/sofa
design Sergio Bicego

PISA tavolino/coffee table
design Mauro Lipparini





MAXIMILIAN divano/sofa
design Sergio Bicego

PISA tavolino/coffee table
design Mauro Lipparini



Aliante

Design Sergio Bicego

La leggerezza come valore, l'essenzialità come obiettivo progettuale: l'eleganza del disegno di Aliante sembra privilegiare l'aspetto estetico del divano per poi sorprendere con un comfort insospettabile alla vista. La collezione Aliante è un sistema di sedute componibili che esprime, a partire dal nome, il concetto di flessibilità e fluidità.

La famiglia Aliante assume differenti e interessanti configurazioni grazie anche al sistema di tavolini d'appoggio, che giocano con lo spazio posizionandosi lateralmente, di fronte al divano oppure tra due elementi della composizione.

La versatilità offerta dai numerosi elementi componibili è ampliata dalle possibilità di personalizzazione del telaio, rivestito in tessuto o in pelle e abbinabile ai cuscini e agli schienali.

Lightness as a value, essentiality as a design objective: the elegance of Aliante's design seems to focus on the aesthetic aspect of the sofa and then surprise with a level of comfort that is visually unexpected. The Aliante collection is a modular seating system that in taking its cue from the name (which means glider in English), expresses the concepts of flexibility and fluidity.

The Aliante family takes on different and interesting configurations thanks also to the system of side tables, which play with space by positioning themselves laterally, in front of the sofa or between two elements of the composition.

The versatility offered by the numerous modular elements is expanded by the possibilities of customizing the frame, covered in fabric or leather and combinable with the cushions and backrests.

ALIANTE divano/sofa
design Sergio Bicego

ALIANTE tavolino/coffee table
design Sergio Bicego



ALIANTE divano/sofa
design Sergio Bicego

ALIANTE tavolino/coffee table
design Sergio Bicego

OPTIC libreria/bookshelf
design Marco Zito



Divani, Sofas.

Divani, Sofas.

ALIANTE divano/sofa
design Sergio Bicego



Divani, Sofas.

ALIANTE divano/sofa
design Sergio Bicego

ALIANTE tavolino/coffee table
design Sergio Bicego

OPTIC libreria/bookshelf
design Marco Zito



Divani, Sofas.

ALIANTE divano/sofa
design Sergio Bicego

ALIANTE tavolino/coffee table
design Sergio Bicego

ROLL libreria/bookshelf
design Dondoli e Pocci

BELT & CROSS pouf
design Alain Gilles

BIO-S lampada da terra/floor lamp
Studio Team Design



ALIANTE divano/sofa
design Sergio Bicego

BELT & CROSS pouf
design Alain Gilles



ALIANTE divano/sofa
design Sergio Bicego

BIO-S lampada da terra/floor lamp
Studio Team Design

ALIANTE tavolino/coffee table
design Sergio Bicego



ALIANTE divano/sofa
design Sergio Bicego

ALIANTE tavolino/coffee table
design Sergio Bicego

ROLL libreria/bookshelf
design Dondoli e Poggi

BELT pouf
design Alain Gilles



ALIANTE divano/sofa
design Sergio Bicego

ALIANTE tavolino/coffee table
design Sergio Bicego

HARPE tavolino/coffee table
design Fabrice Berrux



ALIANTE divano/sofa
design Sergio Bicego

NEUILLY LOUNGE poltrona/armchair
design Fabrice Berrux

NEUILLY POUF pouf
design Fabrice Berrux

MOON tavolino/coffee table
design Gino Carollo

HARPE tavolino/coffee table
design Fabrice Berrux

TWIGS libreria/bookshelf
design Marconato & Zappa



Blend

Design Giuseppe Viganò

Il divano Blend offre una concezione progettuale che sviluppa insieme due concetti: rigidità e libertà formale. La linearità della struttura perimetrale rivestita in cuoio bilancia ed aggiunge valore alla parte imbottita, creando una linea rigorosa che dal basso si allarga verso l'alto. Un elemento forte, distintivo ed apprezzabile da ogni angolazione conferisce a questa collezione rigore: la struttura in cuoio di braccioli e schienale, incornicia la cuscineria, consentendole però al contempo di svilupparsi visivamente sia in altezza che in larghezza. Uno stile messo ancora più in risalto dalla collocazione free-standing, che può rivelare l'andamento fluido e dinamico dello schienale in cuoio, modellato sulla traccia morbida e curvilinea degli elementi imbottiti.

The Blend sofa offers a design that develops the two concepts of rigour and formal freedom simultaneously. The linearity of the perimeter frame covered in leather balances and adds value to the upholstered section, creating a rigorous line that widens upwards from the bottom. A strong and distinctive element appreciable from every angle gives this collection rigour: the leather structure of the armrests and backrest frames the cushions while at the same time allowing them to visually develop both in height and width. This style is highlighted even more by the free-standing position, which reveals the fluid and dynamic flow of the leather backrest, modelled on the soft and curvilinear line of the upholstered elements.

BLEND divano/sofa
design Giuseppe Viganò

JAZZ tavolino/coffee table
design Bonaldo Lab

BIO-S lampada da terra/floor lamp
Studio Team Design

110 /
111



BLEND divano/sofa
design Giuseppe Viganò



Divani, Sofas.

BLEND divano/sofa
design Giuseppe Viganò

JAZZ tavolino/coffee table
design Bonaldo Lab

FOLD specchio/mirror
design Tratto09



Divani, Sofas.

BLEND divano/sofa
design Giuseppe Viganò

BIO-S lampada da terra/floor lamp
Studio Team Design

JAZZ tavolino/coffee table
design Bonaldo Lab

FOLD specchio/mirror
design Tratto09



Divani, Sofas.

Divani, Sofas.

BLEND divano/sofa
design Giuseppe Viganò

PIN lampada da terra/floor lamp
design Dondoli e Poggi



Divani, Sofas.

BLEND divano/sofa
design Giuseppe Viganò



Divani, Sofas.

BLEND divano/sofa
design Giuseppe Viganò

ADONE specchio/mirror
design Marconato & Zappa

HARPE tavolino/coffee table
design Fabrice Berrux

JAZZ tavolino/coffee table
design Bonaldo Lab

PIN lampada da terra/floor lamp
design Dondoli e Pocci



BLEND divano/sofa
design Giuseppe Viganò

ADONE specchio/mirror
design Marconato & Zappa

JAZZ tavolino/coffee table
design Bonaldo Lab



Peanut B.

Design Mauro Lipparini

Una forte valenza espressiva per un pezzo d'arredo destinato a stimolare gli aspetti più creativi e fantasiosi della zona living. Una morbidezza avvolgente che offre intensi momenti di relax.

Peanut B. si caratterizza per i grandi moduli morbidi e squadrati, che compongono le diverse parti del divano e offrono innumerevoli possibilità di configurazione tra cui: a isola, centro stanza o bi-facciale.

Alcuni elementi della collezione Peanut B. sono dotati di un meccanismo incorporato di allungamento della seduta così da avere un maggiore confort.

Il rivestimento, in tessuto o pelle, è sfoderabile e può essere scelto monocromatico o in tonalità e pattern diversi per ogni modulo.

A striking expressive value for a piece of furniture intended to stimulate the most creative and imaginative aspects of the living area, along with an enveloping softness that offers intense moments of relaxation.

Peanut B. is characterized by the large, soft, square modules which make up the different parts of the sofa and offer countless configuration possibilities including island format, freestanding or double-sided.

Certain elements of the Peanut B. collection are equipped with a built-in seat extension mechanism for greater comfort. The cover in fabric or leather is removable and can be chosen in a single colour or in different shades and patterns for each module.

PEANUT B. divano/sofa
design Mauro Lipparini

KUMO tavolino/coffee table
design Mauro Lipparini

ACQUERELLI lampada da terra/floor lamp
design Marco Zito

122 /
123



PEANUT B. divano/sofa
design Mauro Lipparini

KUMO tavolino/coffee table
design Mauro Lipparini

OPTIC libreria/bookshelf
design Marco Zito



PEANUT B. divano/sofa
design Mauro Lipparini

KUMO tavolino/coffee table
design Mauro Lipparini

OPTIC libreria/bookshelf
design Marco Zito





PEANUT B. divano/sofa
design Mauro Lipparini



Divani. Sofas.

PEANUT B. divano/sofa
design Mauro Lipparini

BIO-S lampada da terra/floor lamp
Studio Team Design



Divani. Sofas.

PEANUT B. divano/sofa
design Mauro Lipparini

DOGMA libreria/bookshelf
design Alain Gilles

PISA tavolino/coffee table
design Mauro Lipparini

COMBINATION tavolino/coffee table
design Alain Gilles



PEANUT B. divano/sofa
design Mauro Lipparini



Divani, Sofas.

PEANUT B. divano/sofa
design Mauro Lipparini



134 /
135

Divani, Sofas.

PEANUT B. divano/sofa
design Mauro Lipparini



Peanut B.X.

Design Mauro Lipparini

Peanut B.X. è un sistema di sedute caratterizzato da geometrie variabili e dalla pienezza dei volumi.

Grazie a elementi di varie dimensioni e dalle forme asimmetriche, pentagonali o trapezoidali e alle combinazioni con elementi regolari, si creano composizioni originali e personalizzabili: una vera e propria isola di morbidezza, simbolo di relax, che diventa protagonista della zona living.

La bifaccialità e la sequenzialità come contenuti progettuali distintivi dell'architettura del divano Peanut B.X. gli permettono di arredare lo spazio in modo fluido, interagendo dinamicamente con l'ambiente.

Le linee morbide delle cuciture, che contornano i volumi delle sedute, si contrappongono alle forme più rigorose e geometriche della struttura, con diverse profondità della seduta.

The Peanut B.X. seating system stands out on account of its variable geometries and fullness of volumes.

Thanks to elements of different sizes, asymmetrical, pentagonal or trapezoidal shapes and combinations with regular elements, original and customizable compositions can be created, resulting in genuine islands of softness and a symbol of relaxation which becomes the star attraction of any living area.

The distinctive design contents and the double-sided and sequential nature of the styling of the Peanut B.X. sofa allow it to fluidly furnish spaces, interacting dynamically with the surrounding environment.

The soft lines of the stitching, which envelop the volumes of the seats, contrast with the more rigorous and geometric shapes of the frame, offering a range of different seat depths.

PEANUT B.X. divano/sofa
design Mauro Lipparini

KUMO tavolino/coffee table
design Mauro Lipparini

138 /
139



PEANUT B.X. divano/sofa
design Mauro Lipparini

KUMO tavolino/coffee table
design Mauro Lipparini

140
/141

Divani, Sofas.

Divani, Sofas.



PEANUT B.X. divano/sofa
design Mauro Lipparini

KUMO tavolino/coffee table
design Mauro Lipparini

PEANUT B.X. divano/sofa
design Mauro Lipparini



PEANUT B.X. divano/sofa
design Mauro Lipparini

KUMO tavolino/coffee table
design Mauro Lipparini

144 /
145

Divani, Sofas.

Divani, Sofas.



PEANUT B.X. divano/sofa
design Mauro Lipparini

KUMO tavolino/coffee table
design Mauro Lipparini



PEANUT B.X. divano/sofa
design Mauro Lipparini



PEANUT B.X. divano/sofa
design Mauro Lipparini



PEANUT B.X. divano/sofa
design Mauro Lipparini

KUMO tavolino/coffee table
design Mauro Lipparini

150
/ 151



Ever More

Design Sergio Bicego

La sottile solcatura che attraversa orizzontalmente i braccioli, riprendendo il piano di seduta dei cuscini per proseguire nello schienale, caratterizza immediatamente il profilo del divano Ever More, tracciando una linea di stile nello spazio del living. Un elemento di continuità visiva che scandisce il dialogo tra le forme e le proporzioni, armonizzando l'immagine più rigorosa della struttura e quella più informale dei grandi e morbidi cuscini. I numerosi elementi modulari della famiglia Ever More (tra cui: lineari, angolari, pouf e chaise longue) consentono di immaginare svariate configurazioni, sia a parete, sia a centro stanza.

The thin horizontal groove that bisects the armrests, following along the seat surface of the cushions and continuing into the backrest, immediately sums up the profile of the Ever More sofa, tracing a line of style through any living room. It is an element of visual continuity that marks the dialogue between shapes and proportions, harmonizing the more rigorous image of the frame and the more informal image of the large, soft cushions. The numerous modular elements of the Ever More family include a linear element, a corner, pouf and chaise longue versions which allow you to create a wide range of configurations, both against the wall and in the centre of the room.

EVER MORE divano/sofa
design Sergio Bicego

JAZZ tavolino/coffee table
design Bonaldo Lab

PIN lampada da terra/floor lamp
design Dondoli e Pocci

152 /
153



EVER MORE divano/sofa
design Sergio Bicego

ALPILLES poltrona/armchair
design Fabrice Berrux

JAZZ tavolino/coffee table
design Bonaldo Lab

PIN lampada da terra/floor lamp
design Dondoli e Pocci

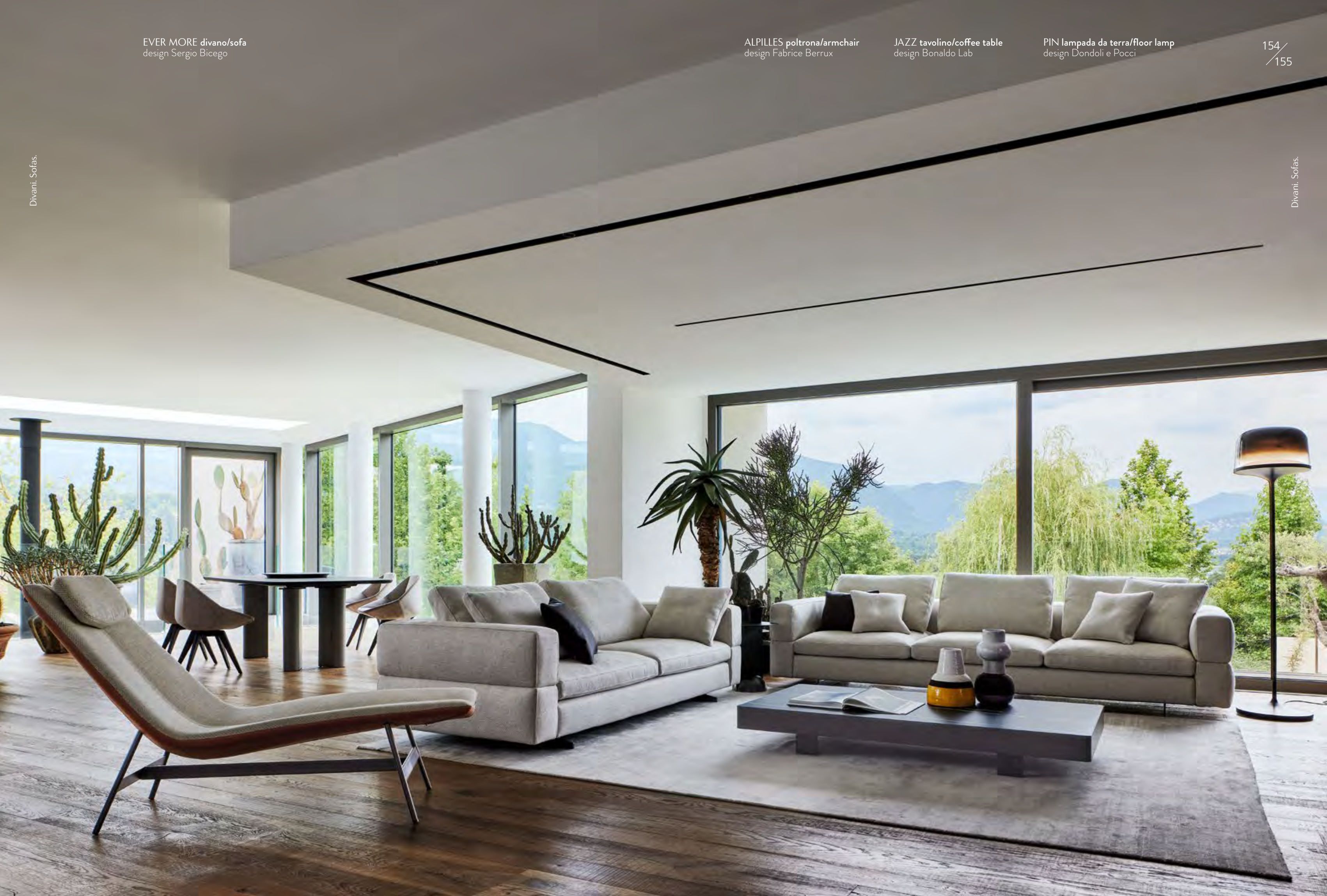



EVER MORE divano/sofa
design Sergio Bicego



Divani. Sofas.

EVER MORE divano/sofa
design Sergio Bicego

COMBINATION tavolino/coffee table
design Alain Gilles



Divani. Sofas.

EVER MORE divano/sofa
design Sergio Bicego

BIO-S lampada da terra/floor lamp
Studio Team Design

COMBINATION tavolino/coffee table
design Alain Gilles

160
/161

Divani, Sofas.

Divani, Sofas.



EVER MORE divano/sofa
design Sergio Bicego



Divani, Sofas.

EVER MORE divano/sofa
design Sergio Bicego

COMBINATION tavolino/coffee table
design Alain Gilles

ROLL libreria/bookshelf
design Dondoli e Poggi



Divani, Sofas.

EVER MORE divano/sofa
design Sergio Bicego

COMBINATION tavolino/coffee table
design Alain Gilles

ROLL libreria/bookshelf
design Dondoli e Poggi

164 /
165

Divani, Sofas.

Divani, Sofas.



EVER MORE divano/sofa
design Sergio Bicego

KASUMI tavolino/coffee table
design Toshiyuki Yoshino

HARPE tavolino/coffee table
design Fabrice Berrux



EVER MORE divano/sofa
design Sergio Bicego

NOOR LOUNGE poltrona/armchair
design Dondoli e Poggi

KASUMI tavolino/coffee table
design Toshiyuki Yoshino

HARPE tavolino/coffee table
design Fabrice Berrux

VAGUE porta riviste/magazine rack
design Roberto Paoli

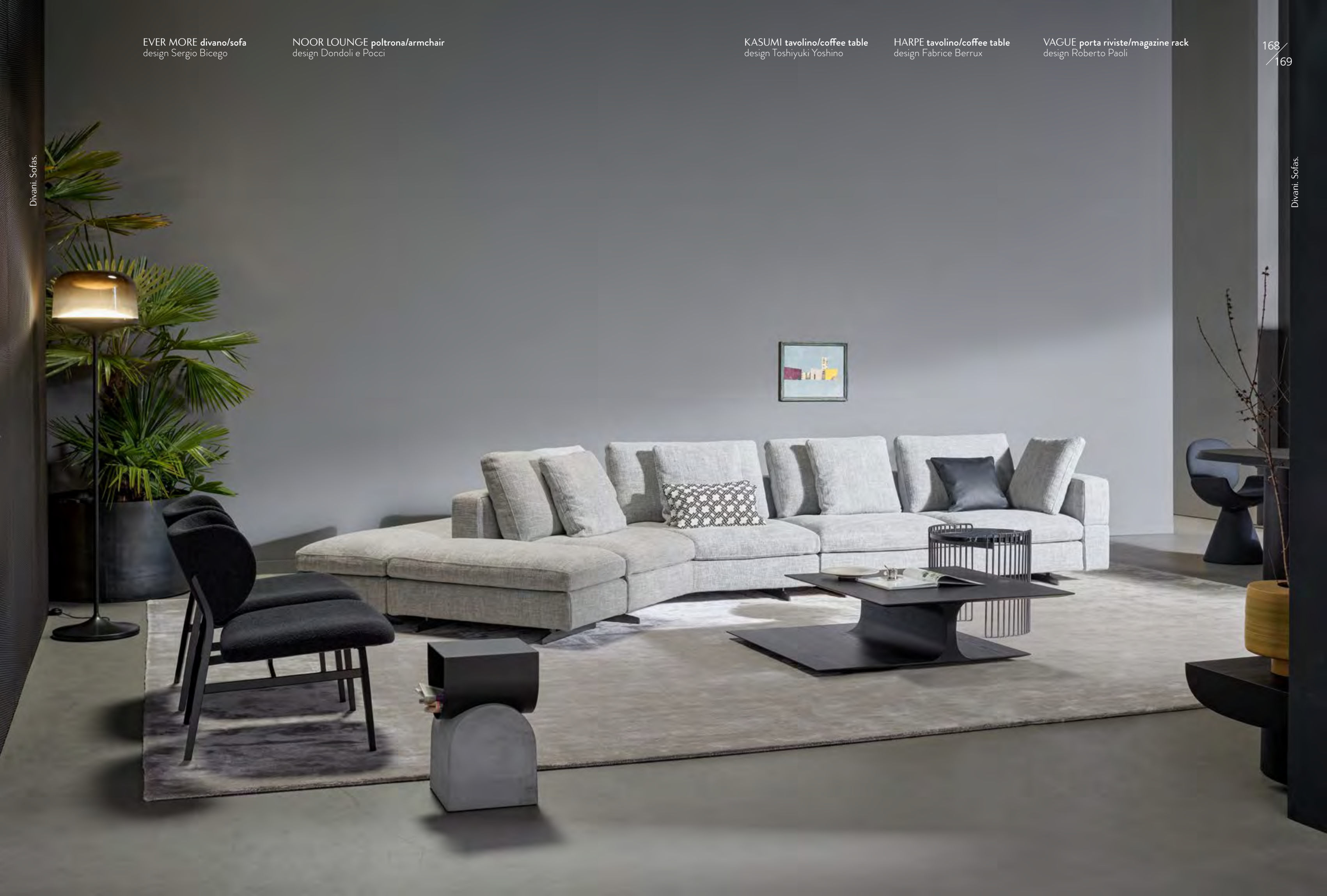

Panorama New

Design Fabrice Berrux

Panorama New è un divano componibile modulare in grado di creare un paesaggio domestico inedito: luoghi aggreganti, isole di comodità, veri e propri rifugi su cui abbandonarsi in libertà. La sua geometria è uno stimolo alla combinazione di diversi elementi, per trasformare la zona living nel più caldo e accogliente degli ambienti. La collezione di divani Panorama New si basa su un particolare elemento che può essere considerato la vera e propria unità di misura del sistema: il pouf di forma esagonale che, con braccioli e schienale, diventa poltrona e che, a sua volta, può essere combinata con altre poltrone e con i divani per ottenere le più diverse configurazioni, massima espressione di personalizzazione e creatività. Il rivestimento, in tessuto o pelle, è completamente sfoderabile ed è caratterizzato da una particolare trapuntatura su braccioli e schienale.

Panorama New is a modular sectional sofa capable of creating an unprecedented domestic landscape, offering spaces for meeting, islands of comfort and genuine refuges in which to abandon yourself in complete freedom. Its geometry stimulates the combination of different elements, transforming the living area into the warmest and most welcoming of environments. The Panorama New sofa collection is based on a particular element that can be considered the system's real unit of measurement: the hexagonal shaped pouf which, with armrests and backrest, becomes an armchair and which in turn can be combined with other armchairs and sofas to obtain the most diverse configurations. As such it represents the maximum expression of personalisation and creativity. The cover, in fabric or leather, is completely removable and features a special quilting pattern on the armrests and backrest.



PANORAMA NEW divano/sofa
design Fabrice Berrux

PASSY tavolino/coffee table
design Fabrice Berrux

170/
171

PANORAMA NEW divano/sofa
design Fabrice Berrux

PASSY tavolino/coffee table
design Fabrice Berrux

DOGMA libreria/bookshelf
design Alain Gilles

PIN lampada da terra/floor lamp
design Dondoli e Pocci



PANORAMA NEW divano/sofa
design Fabrice Berrux

PASSY tavolino/coffee table
design Fabrice Berrux

DOGMA libreria/bookshelf
design Alain Gilles

SOFI lampada da terra/floor lamp
Studio Team Design

Divani, Sofas.



Divani, Sofas.

PANORAMA NEW divano/sofa
design Fabrice Berrux

PASSY tavolino/coffee table
design Fabrice Berrux

DOGMA libreria/bookshelf
design Alain Gilles

PIN lampada da terra/floor lamp
design Dondoli e Pocci

176
/177

Divani, Sofas.

Divani, Sofas.



PANORAMA NEW divano/sofa
design Fabrice Berrux



Divani, Sofas.

PANORAMA NEW divano/sofa
design Fabrice Berrux

MAGIC tavolino/coffee table
design Fabrice Berrux

BIO-S lampada da terra/floor lamp
Studio Team Design

178
/179



Divani, Sofas.

PANORAMA NEW divano/sofa
design Fabrice Berrux



Divani, Sofas.

PANORAMA NEW divano/sofa
design Fabrice Berrux

DOGMA libreria/bookshelf
design Alain Gilles

COMBINATION tavolino/coffee table
design Alain Gilles

BIO-S lampada da terra/floor lamp
Studio Team Design

180
/
181



Divani, Sofas.

Soft Island

Design Sergio Bicego

La piacevolezza del design di Soft Island è data dall'equilibrio tra astrazione e decoro. Alle geometrie essenziali e rigorose e a soluzioni estetiche e funzionali (quali il cuscino di seduta che può estendersi per tutta la larghezza del divano), fa da contrappunto la ricercatezza delle trame e dei dettagli, come, ad esempio, l'impuntatura della seduta. Analogamente, la sua ampia scocca permette di accogliere e di disporre liberamente i morbidi cuscini dello schienale, che invitano a un comfort informale. Soft Island è proposto con rivestimento completamente sfoderabile in tessuto o pelle, messo in risalto da quattro eleganti piedi metallici. Il divano è disponibile anche con una struttura metallica a vista che ne definisce il profilo perimetrale conferendogli un ulteriore tocco di raffinatezza ed eleganza.

The charm and appeal of Soft Island's design come from the balance between abstraction and decoration. The essential and rigorous geometries together with the aesthetic and functional solutions (such as the seat cushion which extends along the entire width of the sofa) are counterpointed by the elegance of the textures and details, such as for example, the stitching of the seats. Similarly, the sofa's generous body allows the soft back cushions to be freely positioned and arranged, thereby leading to informal comfort. Soft Island is available with a completely removable cover in fabric or leather and highlighted by four elegant metal feet. The sofa is also available with an exposed metal frame that outlines its perimeter profile, giving it a further touch of refinement and elegance.

SOFT ISLAND divano/sofa
design Sergio Bicego

BIO-S lampada da terra/floor lamp
Studio Team Design

182
183



SOFT ISLAND divano/sofa
design Sergio Bicego

PISA tavolino/coffee table
design Mauro Lipparini

BIO-S lampada da terra/floor lamp
Studio Team Design



SOFT ISLAND divano/sofa
design Sergio Bicego



SOFT ISLAND divano/sofa
design Sergio Bicego



SOFT ISLAND divano/sofa
design Sergio Bicego

MARK pouf
design Bonaldo Lab

PIN lampada da terra/floor lamp
design Dondoli e Pocci

KUMO tavolino/coffee table
design Mauro Lipparini

ROLL libreria/bookshelf
design Dondoli e Pocci

SOFT ISLAND pouf
design Sergio Bicego



Divani, Sofas.

Divani, Sofas.

SOFT ISLAND divano/sofa
design Sergio Bicego

MARK pouf
design Bonaldo Lab

PIN lampada da terra/floor lamp
design Dondoli e Poggi

KUMO tavolino/coffee table
design Mauro Lipparini

Divani. Sofas.

Divani. Sofas.



SOFT ISLAND divano/sofa
design Sergio Bicego



Divani, Sofas.

SOFT ISLAND divano/sofa
design Sergio Bicego

DUNE credenza/sideboard
design Giuseppe Viganò

PIN lampada da terra/floor lamp
design Dondoli e Pocci



Divani, Sofas.

SOFT ISLAND divano/sofa
design Sergio Bicego

PIN lampada da terra/floor lamp
design Dondoli e Pocchi

KUMO tavolino/coffee table
design Mauro Lipparini



Paraiso

Design Sergio Bicego

Divano dalla seduta profonda e dallo stile lineare e essenziali, Paraiso è frutto di una calibrata composizione estetica e funzionale dei diversi elementi che lo compongono. Proposto con rivestimento sfoderabile in tessuto o pelle, grazie ai numerosi elementi modulari coordinati può essere liberamente personalizzato anche nella configurazione, per interpretare ogni genere di ambiente. Oltre al classico divano lineare, è possibile dare vita a soluzioni con chaise longue o angolari, o abbinare comodi pouf e una interessante poltrona. Una particolare cura è riservata alla base, con i piedi realizzati in metallo verniciato, oppure rivestiti in pelle Capri.

A sofa with a deep seat and a linear and essential style, Paraiso is the result of a calibrated aesthetic and functional combination of a selection of different elements. Available with removable cover in fabric or leather, thanks to the numerous coordinated modular elements it can also be freely personalised in terms of configuration so as to suit any type of environment. In addition to the classic linear sofa, it is possible to create solutions with chaise longue or corner sofas, or combine comfortable poufs and a striking armchair. Particular attention has been dedicated to the base, with feet either in painted metal, or clad in Capri leather.



PARAISO divano/sofa
design Sergio Bicego

ROLL libreria/bookshelf
design Dondoli e Poggi

BIO-S sospensione/suspension lamp
Studio Team Design

PARAISO divano/sofa
design Sergio Bicego

BIO-S sospensione/suspension lamp
Studio Team Design

HARPE tavolino/coffee table
design Fabrice Berrux

ROLL libreria/bookshelf
design Dondoli e Poggi







PARAISO divano/sofa
design Sergio Bicego

SLEEK poltrona/armchair
design Mauro Lipparini

ELEMENT tavolino/coffee table
design Alain Gilles

OPTIC libreria/bookshelf
design Marco Zito

BIO-S lampada da terra/floor lamp
Studio Team Design

204 /
205

Divani, Sofas.

Divani, Sofas.



PARAISO divano/sofa
design Sergio Bicego



Divani. Sofas.

PARAISO divano/sofa
design Sergio Bicego

ELEMENT tavolino/coffee table
design Alain Gilles

BIO-S lampada da terra/floor lamp
Studio Team Design



Divani. Sofas.





Saddle

Design Giuseppe Viganò

Un elemento imbottito a forma di sella che, ripiegando su sé stesso, dà forma agli schienali e ai braccioli è ciò che identifica il divano Saddle. Una nota di stile originale e armoniosa, sottolineata dalla presenza di un inserto in pelle all'interno del bracciolo, che offre anche la possibilità di giocare negli accostamenti di colori e di finiture con il rivestimento del divano, che può essere in tessuto o in pelle.

La struttura a pozzetto di schienale e braccioli e la seduta imbottita rendono accogliente l'immagine di questo divano e ne mettono in evidenza la valenza stilistica contemporanea.

La possibilità di combinare tra loro vari elementi della famiglia dà vita a numerose configurazioni che possono inserirsi negli ambienti più diversi.

A saddle-shaped upholstered element folded over on itself gives shape to the backrests and armrests and it is this element that best identifies the Saddle sofa. It is an original and harmonious stylistic note which is underlined by the presence of a leather insert within the armrest. This in turn offers the possibility of changing colour and finish combinations with the sofa upholstery, which is available in fabric or leather.

The bathtub-shaped structure of the backrest and armrests and the fully upholstered seat give this sofa a welcoming image and highlight its contemporary stylistic value.

The possibility of combining various elements of the family gives rise to numerous configurations that can be inserted into a vast range of different environments.

SADDLE divano/sofa
design Giuseppe Viganò

HARPE tavolino/coffee table
design Fabrice Berrux

JAZZ tavolino/coffee table
design Bonaldo Lab

212 /
213



SADDLE divano/sofa
design Giuseppe Viganò

JAZZ tavolino/coffee table
design Bonaldo Lab

HARPE tavolino/coffee table
design Fabrice Berrux

ALIX libreria/bookshelf
design Maurizio e Silvia Varsi

BIO-S lampada da terra/floor lamp
Studio Team Design



SADDLE divano/sofa
design Giuseppe Viganò

JAZZ tavolino/coffee table
design Bonaldo Lab

ALPILLES poltrona/armchair
design Fabrice Berrux

HARPE tavolino/coffee table
design Fabrice Berrux

BIO-S lampada da terra/floor lamp
Studio Team Design



SADDLE divano/sofa
design Giuseppe Viganò

ARBOR tavolino/coffee table
design Dondoli e Poggi



SADDLE divano/sofa
design Giuseppe Viganò

ARBOR tavolino/coffee table
design Dondoli e Pocci

220/
221

Divani. Sofas.

Divani. Sofas.



Lars

Design Giuseppe Viganò

Leggero, armonico e lineare, il divano Lars mette insieme forme rigorose con qualità rilevanti di comfort e accoglienza, calibrate sulle posture dinamiche del corpo. Le proporzioni orizzontali della seduta sono bilanciate dai braccioli e dallo schienale slanciato, che sorregge cuscini dalle dimensioni generose. Oltre al divano lineare, la famiglia di elementi componibili consente di dare vita a soluzioni con chaise longue o angolari, da abbinare a comodi pouf o a poltrone coordinate. Dotato di base in metallo, con sottili piedi lineari oppure di basamento sagomato, Lars è proposto con rivestimento in tessuto o pelle, completamente sfoderabile.

Light, harmonious and linear, the Lars sofa combines rigorous shapes with considerable levels of welcoming comfort, all calculated around the dynamic positions of the human body. The horizontal proportions of the seat are balanced by the armrests and the slender backrest, which supports generously sized cushions. In addition to the linear sofa, the family of modular elements allows you to create solutions with chaises longues or corners, or to be combined with comfortable poufs or coordinated armchairs. Available with a metal frame, slender linear feet or a shaped base, Lars comes with a completely removable fabric or leather covering.

LARS divano/sofa
design Giuseppe Viganò

KUMO tavolino/coffee table
design Mauro Lipparini

BARDOT lampada da terra/floor lamp
design Laura Cazzaniga e Ilaria Limonta

222/
223



LARS poltrona/armchair
design Giuseppe Viganò

LARS divano/sofa
design Giuseppe Viganò

KUMO tavolino/coffee table
design Mauro Lipparini

BARDOT lampada da terra/floor lamp
design Laura Cazzaniga e Ilaria Limonta



LARS poltrona/armchair
design Giuseppe Viganò



LARS poltrona/armchair
design Giuseppe Viganò

BARDOT lampada da terra/floor lamp
design Laura Cazzaniga e Ilaria Limonta



LARS poltrona/armchair
design Giuseppe Viganò

LARS divano/sofa
design Giuseppe Viganò

MAGIC tavolino/coffee table
design Fabrice Berrux

PIN lampada da terra/floor lamp
design Dondoli e Pocchi

COMBINATION tavolino/coffee table
design Alain Gilles

228 /
229

Divani. Sofas.

Divani. Sofas.



LARS divano/sofa
design Giuseppe Viganò

PLANET tavolino/coffee table
design Gino Carollo

Divani, Sofas

Divani, Sofas



Skid

Design Giuseppe Viganò

Sobrio ed elegante, il divano Skid colpisce al primo sguardo per la lieve curvatura svasata dei braccioli, che accoglie generosamente gli ampi cuscini della seduta e dello schienale. Una figura leggera e proporzionata, messa ancor più in risalto dalla particolare conformazione della scocca, sollevata da terra da una base metallica, disponibile nelle tipologie a quattro piedi o con basamento a slitta. Oltre alla classica configurazione lineare, gli elementi della famiglia consentono di comporre innumerevoli soluzioni, anche con chaise longue, angolari oppure con l'aggiunta di pouf. Skid è proposto con rivestimento in tessuto o pelle, completamente sfoderabile.

Sober and elegant, at first glance what is striking about the Skid sofa is the slightly flared curvature of the armrests, which generously accommodate the large seat and back cushions. It presents a lightweight and well-proportionated image, highlighted even more by the particular shape of the body which is raised above the ground by a metal base, available in the four-foot or sled base versions. In addition to the classic linear configuration, the elements of the family allow you to create countless different compositions, even with chaises longues, corner chairs or with the addition of poufs. Skid is available with fabric or leather covers, both of which are completely removable.

SKID divano/sofa
design Giuseppe Viganò

ADONE specchio/mirror
design Marconato & Zappa



SKID divano/sofa
design Giuseppe Viganò

ADONE specchio/mirror
design Marconato & Zappa

NEUILLY LOUNGE poltrona/armchair
design Fabrice Berrux

NEUILLY POUF pouf
design Fabrice Berrux

MAGIC tavolino/coffee table
design Fabrice Berrux

COMBINATION tavolino/coffee table
design Alain Gilles

VAGUE porta riviste/magazine rack
design Roberto Paoli

PIN lampada da terra/floor lamp
design Dondoli e Pocci

234
/235



SKID divano/sofa
design Giuseppe Viganò

ADONE specchio/mirror
design Marconato & Zappa



SKID divano/sofa
design Giuseppe Viganò

MAGIC tavolino/coffee table
design Fabrice Berrux

COMBINATION tavolino/coffee table
design Alain Gilles

VAGUE porta riviste/magazine rack
design Roberto Paoli

PIN lampada da terra/floor lamp
design Dondoli e Pocci



SKID divano/sofa
design Giuseppe Viganò

ALIX libreria/bookshelf
design Maurizio e Silvia Varsi



SKID divano/sofa
design Giuseppe Viganò

BIO-S lampada da terra/floor lamp
Studio Team Design

ALIX libreria/bookshelf
design Maurizio e Silvia Varsi

JAZZ tavolino/coffee table
design Bonaldo Lab

240/
241

Divani, Sofas

Divani, Sofas



SKID divano/sofa
design Giuseppe Viganò

ROLL libreria/bookshelf
design Dondoli e Pucci

BIO-S lampada da terra/floor lamp
Studio Team Design

PADDLE tavolino/coffee table
design Mauro Lipparini

OLOS POUF pouf
design Mauro Lipparini



Lovy hi, Lovi low

Design Sergio Bicego

Reinterpretazione originale e contemporanea del design mid-century, la famiglia di imbottiti Lovy permette di interpretare gli spazi più disparati della casa e dell'hospitality.

Lovy è una collezione di divani fissi o componibili, dalle linee originali e inaspettate, sempre arrotondate: le forme semi-ovali, lo schienale accogliente, i braccioli leggermente sporgenti disegnano lo spazio, creando effetti dinamici sul piano visivo.

Principale protagonista della collezione è il divano, caratterizzato dalla forma della seduta, che invita alla conversazione, integrandosi con naturalezza con la poltrona e il pouf coordinati. Diversi elementi componibili si affiancano alle numerose versioni disponibili: Lovy hi (con schienale alto), Lovy low (con schienale basso), Lovy ego (trapuntato), Lovy armchair low (poltrona con schienale basso) o Lovy armchair bergère (poltrona con schienale alto).

An original and contemporary reinterpretation of mid-century design, the Lovy family of upholstered furniture allows you to furnish the most disparate spaces in both the home and hospitality areas.

Lovy is a collection of fixed or modular sofas, with lines that are original and unexpected but always gently rounded. The semi-oval shapes, the welcoming backrest, the slightly protruding armrests all combine to design the surrounding space, creating dynamic visual effects. The leading actor in this ensemble is the sofa. It stands out on account of the shape of the seat, which invites conversation, integrating naturally with the coordinated armchair and pouf. Different modular elements can be combined with the numerous versions available, including Lovy hi (with high backrest), Lovy low (with low backrest), Lovy ego (quilted), the Lovy armchair low (armchair with low backrest) or the Lovy bergère armchair (armchair with high backrest).

LOVY LOW divano/sofa
design Sergio Bicego

244 /
245



LOVY LOW divano/sofa
design Sergio Bicego

SLOT COFFEE TABLE tavolino/coffee table
design Giuseppe Viganò

BIO-S lampada da terra/floor lamp
Studio Team Design

BLABLA MIRROR specchio/mirror
design Marconato & Zappa

BLABLA libreria/bookshelf
design Marconato & Zappa

246/
247

Divani, Sofas.

Divani, Sofas.

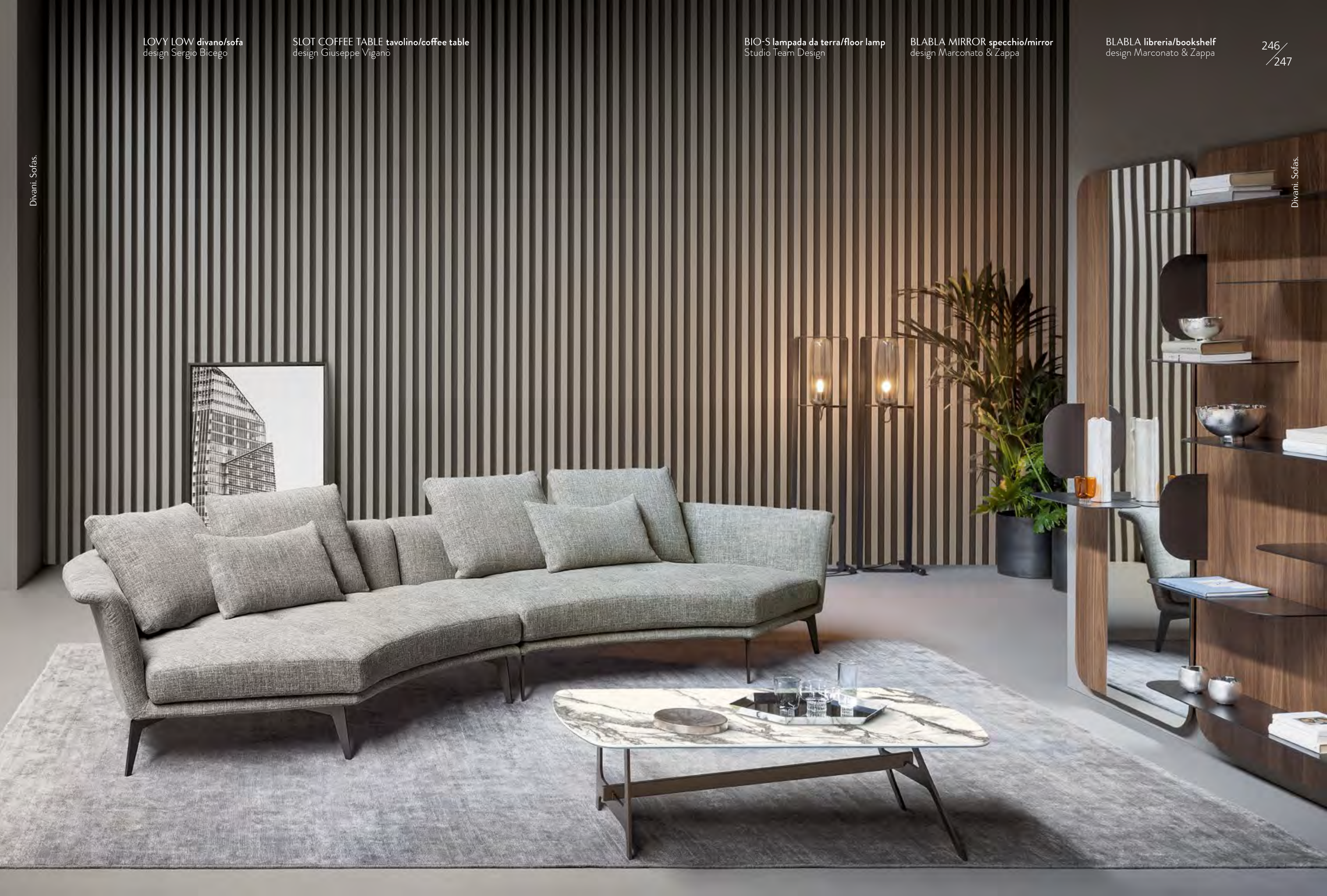

LOVY LOW divano/sofa
design Sergio Bicego

KUMO tavolino/coffee table
design Mauro Lipparini

SOFI lampada da terra/floor lamp
Studio Team Design

SLOT CONSOLE consolle/console
design Giuseppe Viganò



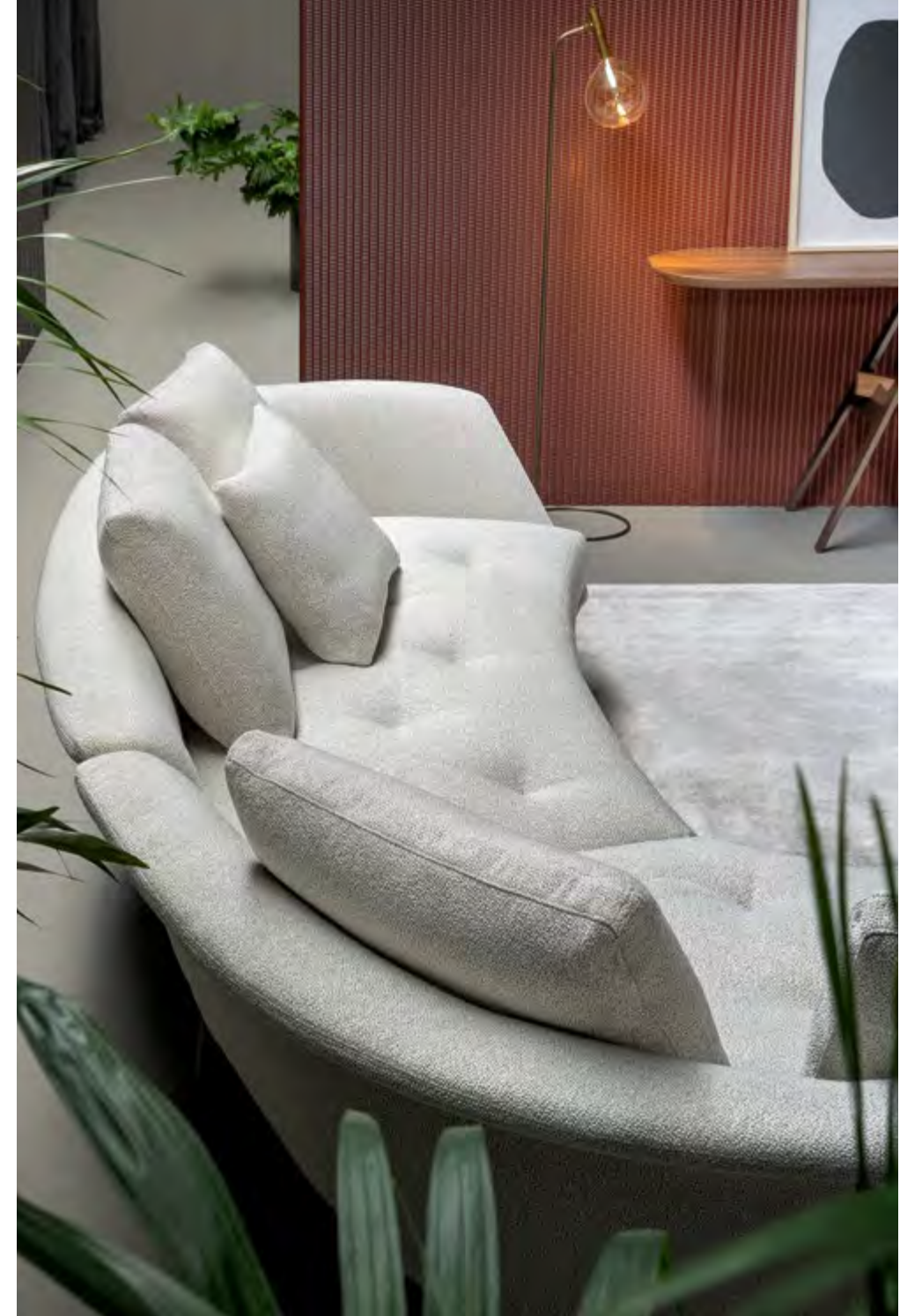

LOVY HI divano/sofa
design Sergio Bicego

DORIAN credenza/sideboard
design Spazioameno

ACQUERELLI lampada da terra/floor lamp
design Marco Zito

HARPE tavolino/coffee table
design Fabrice Berrux



LOVY ARMCHAIR LOW poltrona/armchair
design Sergio Bicego



Divani, Sofas.

LOVY LOW divano/sofa
design Sergio Bicego

SOFI lampada da terra/floor lamp
Studio Team Design

INNESTI tavolino/coffee table
design Paolo Grasselli



Divani, Sofas.

LOVY ARMCHAIR LOW poltrona/armchair
design Sergio Bicego

SOFI lampada da terra/floor lamp
Studio Team Design

LOVY LOW divano/sofa
design Sergio Bicego

INNESTI tavolino/coffee table
design Paolo Grasselli

DUNE credenza/sideboard
design Giuseppe Viganò

SOFI lampada da tavolo/table lamp
Studio Team Design

256
/257

Divani, Sofas.

Divani, Sofas.



LOVY ARMCHAIR BERGÈRE poltrona/armchair
design Sergio Bicego

KUMO tavolino/coffee table
design Mauro Lipparini



LOVY ARMCHAIR BERGÈRE poltrona/armchair
design Sergio Bicego

KUMO tavolino/coffee table
design Mauro Lipparini

SOFI lampada da terra/floor lamp
Studio Team Design



Superhiro

Bonaldo Lab

Minimale e rigoroso nello stile, ma nello stesso tempo accogliente e confortevole, il divano componibile Superhiro è in grado di offrire un grande numero di configurazioni, per interpretare su misura ogni spazio domestico e ogni attitudine quotidiana. Ampio e versatile, il sistema si basa su una vasta famiglia di moduli, che permettono di dare vita a svariate tipologie: lineari, angolari, con chaise longue, meridiane, penisole o con puff in abbinamento. Le possibilità di personalizzazione si estendono all'ampia scelta di trame e tonalità cromatiche del rivestimento, proposto in tessuto o pelle, e completamente sfoderabile.

Minimal and rigorous in style, but at the same time welcoming and comfortable, the Superhiro modular sofa offers a wide variety of configurations, so as to personalise every domestic space and daily habit. Large and versatile, the system is based on an extensive family of modules which allow the creation of numerous combinations including linear, corner, with chaise longue, sections and islands with matching poufs. The customization possibilities extend to offering a wide choice of textures and colours for the upholstery which is available in fabric or leather, and completely removable.

SUPERHIRO divano/sofa
design Bonaldo Lab

RULER credenza/sideboard
design Bonaldo Lab

260 /
261



SUPERHIRO divano/sofa
design Bonaldo Lab

SUPERHIRO pouf
design Bonaldo Lab

RULER credenza/sideboard
design Bonaldo Lab

HARPE tavolino/coffee table
design Fabrice Berrux

JAZZ tavolino/coffee table
design Bonaldo Lab

PIN lampada da terra/floor lamp
design Dondoli e Pocchi



SUPERHIRO divano/sofa
design Bonaldo Lab

SUPERHIRO pouf
design Bonaldo Lab

RULER credenza/sideboard
design Bonaldo Lab

HARPE tavolino/coffee table
design Fabrice Berrux

JAZZ tavolino/coffee table
design Bonaldo Lab

PIN lampada da terra/floor lamp
design Dondoli e Pocci



SUPERHIRO divano/sofa
design Bonaldo Lab

PISA tavolino/coffee table
design Mauro Lipparini

ACQUERELLI lampada da terra/floor lamp
design Marco Zito



SUPERHIRO divano/sofa
design Bonaldo Lab

PISA tavolino/coffee table
design Mauro Lipparini

SUPERHIRO divano/sofa
design Bonaldo Lab

ACQUERELLI lampada da terra/floor lamp
design Marco Zito

OPTIC libreria/bookshelf
design Marco Zito



SUPERHIRO divano/sofa
design Bonaldo Lab

SLEEK poltrona/armchair
design Mauro Lipparini

BIO-S lampada da terra/floor lamp
Studio Team Design

PISA tavolino/coffee table
design Mauro Lipparini

PLANET tavolino/coffee table
design Gino Carollo

ROLL libreria/bookshelf
design Dondoli e Pocci

270/
271

Divani, Sofas.

Divani, Sofas.



SUPERHIRO divano/sofa
design Bonaldo Lab

PISA tavolino/coffee table
design Mauro Lipparini



SUPERHIRO divano/sofa
design Bonaldo Lab

PISA tavolino/coffee table
design Mauro Lipparini

BIO-S lampada da terra/floor lamp
Studio Team Design



SUPER HERO divano/sofa
design Borialto Lab

SLEEK poltrona/armchair
design Mauro Lipparini

PISA tavolino/coffee table
design Mauro Lipparini

PLANET tavolino/coffee table
design Gino Carollo

ROLL libreria/bookshelf
design Dondoli e Poggi



Divani, Sofas.

Divani, Sofas.

Pochi oggetti come le poltrone accolgono e mantengono al centro di un proprio "universo" il corpo umano. Questa qualità, che il design trasforma ed esalta in elemento di stile, nelle poltrone Bonaldo si declina in tutta la libertà consentita, nello stesso tempo, dall'ergonomia e dalla forma. Il risultato è una collezione che ruota attorno alle diverse espressioni del comfort. Questa matrice comune genera una immediata familiarità tra i vari elementi, sorprendentemente accostabili tra loro e a spazi, arredi, situazioni e ambienti di vita, lavoro e convivialità diversi. Un approccio morbido e dinamico per vivere il mondo contemporaneo.

There are precious few objects that welcome and hold the human body at the centre of their own "universe" in the same way that armchairs do. This quality, which design transforms and enhances into an element of style, is expressed in Bonaldo armchairs through every element of freedom permitted simultaneously by ergonomics and shape. The result is a collection that revolves around different expressions of comfort. This shared matrix generates an immediate familiarity between the various elements, which can be combined to surprising effect both with each other and with different spaces, furnishings, situations and environments for living, working and socialising. The result is a gentle yet dynamic approach to living in the modern world.

poltrone/armchairs

POLTRONE / ARMCHAIRS

ALPILLES	P. 330
BODO	P. 350
BRUNO	P. 346
COLIBRÌ	P. 340
CROSS LOUNGE CHAIR	P. 278
GLOBALOVE	P. 334
KITAI	P. 284
LOCK	P. 318
LOVY ARMCHAIR	P. 324
NEUILLY LOUNGE	P. 308
NIKOS	P. 354
NOOR LOUNGE	P. 314
OLOS, OLOS BERGÈRE	P. 290
PIL ARMCHAIR	P. 358
SADDLE ARMCHAIR	P. 362
SLEEK	P. 302
TIRELLA, TIRELLA SOFA	P. 366

Cross lounge chair

Design Alain Gilles

L'accostamento armonico di parti eterogenee della Cross lounge chair, disegnata da Alain Gilles, è il risultato di una reinterpretazione equilibrata e originale della classica poltrona da salotto novecentesca.

La struttura in metallo, completamente a vista, gioca con la tradizionale base a croce che molto spesso viene utilizzata nelle sedie per sostenere la seduta, ma in questo caso è stata enfatizzata fino a diventare una dichiarazione grafica e parte integrante della sua identità. Gli elementi imbottiti, il sedile e lo schienale, hanno proporzioni insolite ed esagerate, volte ad accogliere e ad ospitare.

Una delle caratteristiche principali di questa poltrona è il design del bracciolo, costituito da un unico tubo metallico che viene piegato nella parte anteriore della sedia e prosegue fermandosi poco prima dello schienale.

The harmonious combination of the different parts of the Cross lounge chair designed by Alain Gilles is the result of a balanced and original reinterpretation of the classic twentieth-century lounge chair. The completely exposed metal frame plays with the traditional x-shaped base, an element which is very often used in chairs to support the seat, but which in this case has been emphasized to the point of becoming a graphic statement and an integral part of its identity. The padded elements, the seat and the backrest, have unusual and exaggerated proportions, all aimed at welcoming and hosting the user. One of the main features of this armchair is the design of the armrest, made of a single metal tube that bends back at the front of the chair and continues before coming to a stop just before the backrest.

CROSS LOUNGE CHAIR poltrona/armchair
design Alain Gilles

WAVE paravento/screen
design Marconato & Zappa

278 /
279



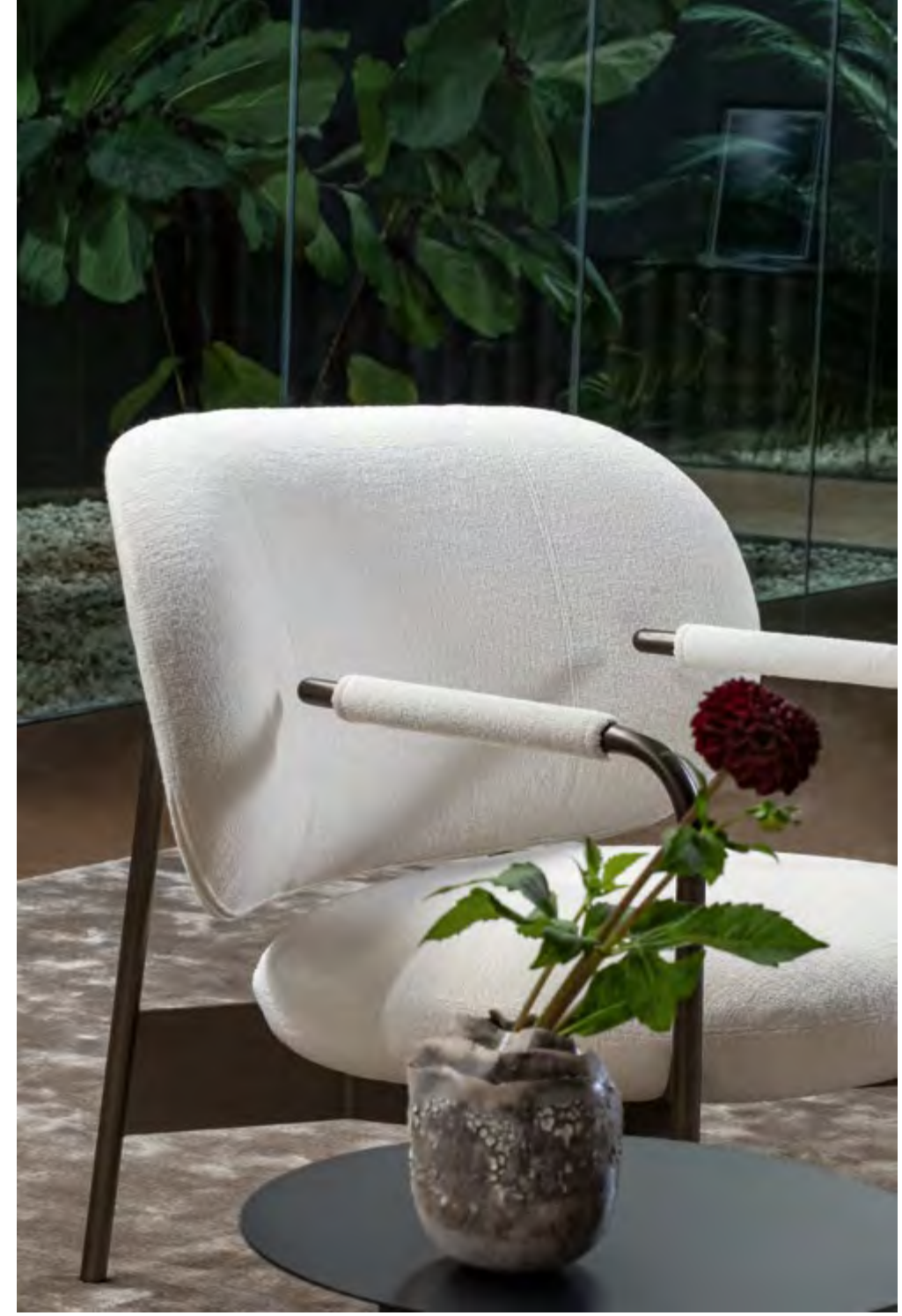



Kitai

Design Marconato & Zappa

Compatta e accogliente, la poltroncina Kitai gioca sull'equilibrio delle proporzioni e delle forme per inserirsi con naturalezza nei più disparati ambiti dell'abitare e dell'hospitality, unendo allo stile il comfort garantito dall'imbottitura, morbida e confortevole. Caratteristiche spiccatamente contemporanee e, insieme, classiche e senza tempo, che la rendono ideale sia per armonizzarsi con gli stili d'arredo più disparati, sia per l'uso in molteplici contesti e momenti della giornata, sia nella zona giorno sia nella zona notte o nell'ufficio: dalle conversazioni informali, al relax, all'attesa negli ambienti di rappresentanza.

Compact and welcoming, the Kitai armchair plays on the balance of proportions and shapes to fit naturally into the most disparate living and hospitality areas, combining style with the comfort guaranteed by the soft and comfortable padding. These characteristics are markedly contemporary yet classic and timeless at the same time, something which make it ideal both for harmonizing with different furnishing styles, and for use in multiple contexts and moments of the day, both in the living area, the sleeping area or in the office: ideal for informal conversations, relaxing or waiting in reception rooms.

KITAI poltrona/armchair
design Marconato & Zappa

PADDLE tavolino/coffee table
design Mauro Lipparini

PIN lampada da terra/floor lamp
design Dondoli e Poggi

284 /
285



KITAI poltrona/armchair
design Marconato & Zappa



Poltrone. Armchairs.

KITAI poltrona/armchair
design Marconato & Zappa

DOGMA libreria/bookshelf
design Alain Gilles

PIN lampada da terra/floor lamp
design Dondoli e Pocci



Poltrone. Armchairs.



Olos

Design Mauro Lipparini

La chiarezza formale e l'eleganza immediata di Olos derivano da una rilettura razionale e calibrata dei codici stilistici del classico design nordico. Essenziale e versatile, la poltrona disegnata da Mauro Lipparini trova così una naturale collocazione sia nella zona giorno della casa, sia nelle aree di rappresentanza dell'hospitality, non meno che negli studi o nei contesti direzionali degli uffici. Rivestita nelle parti imbottite in tessuto, pelle o ecopelle, è caratterizzata dalla scocca portante a guscio in legno lamellare curvato, sostenuta da una gamba centrale in metallo con movimento girevole.

The formal clarity and immediate elegance of Olos derive from a rational and carefully calibrated rereading of the stylistic codes of classic Nordic design. Essential and versatile, this armchair designed by Mauro Lipparini thus finds its natural home both in the domestic living space and in hospitality reception areas, as well as in studios or office management contexts. With the padded sections covered in fabric, leather or eco-leather, it is recognizable by the load-bearing shell in curved laminated wood, supported by a central metal leg with swivel movement.

OLOS poltrona/armchair
design Mauro Lipparini

KAOS libreria/bookshelf
design Mauro Lipparini

JAZZ tavolino/coffee table
design Bonaldo Lab

290/
291



OLOS poltrona/armchair
design Mauro Lipparini



Poltrone. Armchairs.

OLOS poltrona/armchair
design Mauro Lipparini

BACKDROP credenza/sideboard
design Alain Gilles

ACQUERELLI lampada da terra/floor lamp
design Marco Zito



Poltrone. Armchairs.



Olos bergère

Design Mauro Lipparini

Arricchisce la famiglia la poltrona Olos bergère dalle forme più ampie, caratterizzate anch'esse dalla linea della scocca portante in legno lamellare curvato, che agisce come un accogliente guscio protettivo per ricevere le rotondità della seduta e dello schienale. Disponibile a completare la collezione il poggiapiedi coordinato Olos footrest.

The family is enlarged with the Olos bergère armchair with wider shapes, yet still featuring the load-bearing shell in curved laminated wood, which acts as a welcoming protective container to house the roundness of the seat and backrest. The collection is completed with the matching Olos footrest.

OLOS BERGÈRE poltrona/armchair
design Mauro Lipparini

DOGMA libreria/bookshelf
design Alain Gilles

PIN lampada da terra/floor lamp
design Dondoli e Pocci

296 /
297

OLOS FOOTREST poggiapiedi/footrest
design Mauro Lipparini

COMBINATION tavolino/coffee table
design Alain Gilles



OLOS BERGÈRE poltrona/armchair
design Mauro Lipparini



Poltrone. Armchairs.

OLOS BERGÈRE poltrona/armchair
design Mauro Lipparini

DOGMA libreria/bookshelf
design Alain Gilles

PIN lampada da terra/floor lamp
design Dondoli e Poggi

COMBINATION tavolino/coffee table
design Alain Gilles

298
/299



Poltrone. Armchairs.

OLOS BERGÈRE poltrona/armchair
design Mauro Lipparini

OLOS FOOTREST poggiapiedi/footrest
design Mauro Lipparini

SOFI lampada da terra/floor lamp
Studio Team Design



OLOS BERGÈRE poltrona/armchair
design Mauro Lipparini

OLOS FOOTREST poggiapiedi/footrest
design Mauro Lipparini

MUSA specchio/mirror
design Spazioameno



Sleek

Design Mauro Lipparini

Il gioco di volumi portanti e forme geometriche ben definite di Sleek custodisce qualità sorprendenti di comfort e di ergonomia che si rivelano appieno soltanto all'uso. Il progetto disegnato da Mauro Lipparini prende corpo a partire dalle forme dei volumi della seduta-schienale, semplicemente appoggiati su una leggera ed essenziale struttura metallica, che sembra curvarsi per sostenere le parti imbottite, agendo così visivamente per contrasto. Proposta sia in versione girevole sia nel modello a quattro gambe, Sleek è personalizzabile attraverso numerose finiture e varianti cromatiche.

The interplay between Sleek's load-bearing volumes and well-defined geometric shapes guarantees surprising qualities of comfort and ergonomics that are only fully revealed during use. Mauro Lipparini's design takes shape by starting from the forms of the seat/backrest volumes, simply resting on a light and essential metal frame which seems to curve to support the padded sections, thus creating a visual contrast. Available in both swivel and four-legged versions, Sleek can be customized through numerous finishes and colours.

SLEEK poltrona/armchair
design Mauro Lipparini

BIO-S lampada da terra/floor lamp
Studio Team Design

302 /
303



SLEEK poltrona/armchair
design Mauro Lipparini



Poltrone. Armchairs.

SLEEK poltrona/armchair
design Mauro Lipparini

PISA tavolino/coffee table
design Mauro Lipparini

ROLL libreria/bookshelf
design Dondoli e Poggi



Poltrone. Armchairs.



Neuilly lounge

Design Fabrice Berrux

Le geometrie primarie di Neuilly lounge custodiscono segretamente la spiccata capacità della poltrona di accogliere il corpo nel massimo comfort. L'essenza del progetto di Fabrice Berrux sta nell'uso calibrato di pochi elementi, composti con chiarezza: da un lato la seduta tonda e lo schienale-bracciolo a forma semicircolare, dall'altra l'essenziale struttura in tubolari metallici che esalta le forme curve e accoglienti delle parti imbottite. Disponibile in numerose varianti nelle finiture, la poltrona completa una collezione che comprende sedia, sgabello e pouf.

The primary geometries of the Neuilly lounge conceal the armchair's striking ability to accommodate the body in maximum comfort. The essence of Fabrice Berrux's design lies in the calibrated use of a few simple elements clearly combined: on the one hand there is the round seat and semicircular shaped backrest/armrest, on the other the minimalist metal tube frame which enhances the curved shapes and welcoming padded parts. Available in numerous finish variations, the armchair completes a collection that includes chair, stool and pouf.



NEUILLY LOUNGE poltrona/armchair
design Fabrice Berrux

FOIL libreria/bookshelf
design Maurizio e Silvia Varsi

COMBINATION tavolino/coffee table
design Alain Gilles

308 /
309

NEUILLY POUF pouf
design Fabrice Berrux

NEUILLY LOUNGE poltrona/armchair
design Fabrice Berrux

NEUILLY POUF pouf
design Fabrice Berrux

COMBINATION tavolino/coffee table
design Alain Gilles

FOIL libreria/bookshelf
design Maurizio e Silvia Varsi

PIN lampada da terra/floor lamp
design Dondoli e Pocci

310/
311

Poltrone. Armchairs.

Poltrone. Armchairs.



NEUILLY LOUNGE poltrona/armchair
design Fabrice Berrux



Poltrone. Armchairs.

NEUILLY LOUNGE poltrona/armchair
design Fabrice Berrux

NEUILLY POUF pouf
design Fabrice Berrux



Poltrone. Armchairs.

Noor lounge

Design Dondoli e Pocci

Le dimensioni generose e il profilo ergonomico della seduta e dello schienale di Noor lounge rendono la poltrona strumento ideale per rilassarsi, capace di assecondare efficacemente tutti i movimenti del corpo. A proprio agio sia in contesto domestico, nei salotti o negli studi, sia nelle aree di rappresentanza di uffici e hospitality, Noor lounge si caratterizza visivamente per la morbidezza delle parti imbottite, che agisce per contrasto con le linee essenziali e decise della rigorosa struttura metallica portante, stabilendo una naturale armonia con altri elementi della collezione, arricchendo così le possibilità d'arredo.

The generous dimensions and ergonomic profile of the seat and backrest of the Noor lounge armchair make it the ideal tool for relaxing, capable of effectively supporting every body movement. Perfectly suited for domestic contexts such as living rooms or studies, corporate representative areas in offices and the hospitality sector, the Noor lounge is visually characterized by the softness of the padded sections which act in contrast to the essential and decisive lines of the rigorous metal load-bearing frame, establishing a natural harmony with other elements of the collection and thereby expanding the furnishing possibilities.

NOOR LOUNGE poltrona/armchair
design Dondoli e Pocci

VAGUE porta riviste/magazine rack
design Roberto Paoli

314 /
315





Lock

Design Alessandro Busana

Esito di un unico, chiaro, gesto progettuale, la poltrona Lock prende corpo dallo sviluppo di un unico grande nastro imbottito, che gira su sé stesso per formare, in sequenza: la seduta, i braccioli e lo schienale. Lo spessore variabile di questo elemento (più importante nella seduta e assottigliato verso lo schienale) permette di sommare comfort e dinamicità visiva. Proposta anche nella versione Lock ego con trapuntatura, è disponibile con rivestimento sfoderabile in tessuto, ecopelle o pelle.

La poltrona è disponibile o con un unico rivestimento oppure con doppio rivestimento (diverso per la parte frontale della seduta e per lo schienale). La base, in metallo verniciato, è a quattro gambe oppure a base girevole. Il poggiapiedi optional, Lock footrest, completa la seduta.

The result of a single, clear design approach, the Lock armchair takes its shape from the unfolding of a single large padded ribbon which turns around itself to form the seat, the armrests and the backrest in that order. The variable thickness of this element (larger in the seat and thinner towards the backrest) gives a combination of comfort and visual dynamism. The Lock ego version with quilting is also available which comes with removable cover in fabric, eco-leather or leather.

The armchair is available either with a single or double piece cover (different for the front part of the seat and the backrest) while the base, in painted metal, has four legs or a swivel base. The optional Lock footrest completes the ensemble.

LOCK poltrona/armchair
design Alessandro Busana

318 /
319



LOCK poltrona/armchair
design Alessandro Busana

LOCK FOOTREST poggiapiedi/footrest
design Alessandro Busana



Poltrone. Armchairs.

LOCK poltrona/armchair
design Alessandro Busana

LOCK FOOTREST poggiapiedi/footrest
design Alessandro Busana

COMBINATION tavolino/coffee table
design Alain Gilles

320/
321



Poltrone. Armchairs.

LOCK EGO poltrona/armchair
design Alessandro Busana



Poltrone. Armchairs.

LOCK poltrona/armchair
design Alessandro Busana

LOCK EGO poltrona/armchair
design Alessandro Busana

LOCK poltrona/armchair
design Alessandro Busana



Poltrone. Armchairs.

Lovy armchair

Design Sergio Bicego

Elemento essenziale di un'ampia collezione di imbottiti, la poltrona Lovy armchair si distingue per l'impianto di seduta dall'andamento semi-ovale, che invita alla naturale conversazione e genera movimento visivo. La forza plastica delle porzioni imbottite è ulteriormente valorizzata dal rivestimento in tessuto sfoderabile e dai piedi in metallo, disponibili in numerose colorazioni e finiture. Lovy armchair è proposta nelle versioni con schienale basso (Lovy armchair low) e con schienale alto (Lovy armchair bergère), che riprende le linee del classico modello di poltrona settecentesca. Tutti i modelli sono abbinabili a pouf coordinati, tondi o quadrati.

An essential element of a large collection of upholstered furniture, the Lovy armchair catches the eye thanks to its semi-oval frame, which naturally invites comment and conversation and generates visual movement. The flexible strength of the padded sections is further enhanced by the removable fabric covering and metal feet, available in numerous colours and finishes. The Lovy armchair is available in versions with a low backrest (Lovy armchair low) and with high backrest (Lovy armchair bergère) which recalls the lines of the classic eighteenth-century armchair. Each model can be combined with coordinated round or square poufs.

LOVY ARMCHAIR LOW poltrona/armchair
design Sergio Bicego

PIN lampada da terra/floor lamp
design Dondoli e Pocci

LOVY POUF pouf
design Sergio Bicego

324 /
325



LOVY ARMCHAIR BERGÈRE poltrona/armchair
design Sergio Bicego

KUMO tavolino/coffee table
design Mauro Lipparini



LOVY ARMCHAIR BERGÈRE poltrona/armchair
design Sergio Bicego

KUMO tavolino/coffee table
design Mauro Lipparini

SOFI lampada da terra/floor lamp
Studio Team Design



LOVY ARMCHAIR BERGÈRE poltrona/armchair
design Sergio Bicego



Poltrone. Armchairs.

LOVY ARMCHAIR BERGÈRE poltrona/armchair
design Sergio Bicego

LOVY POUF pouf
design Sergio Bicego



Poltrone. Armchairs.

Alpilles

Design Fabrice Berrux

Nel nome e nella forma, la chaise longue Alpilles richiama il profilo dei rilievi montuosi del sud della Francia, così come la cultura moderna da cui scaturisce lo stile di questa confortevole ed elegante tipologia di poltrona. Interpretando il tema in chiave contemporanea, il suo design gioca sull'accostamento nitido tra due parti: il sinuoso monoblocco imbottito della seduta-schienale e la struttura metallica portante, su cui il primo è semplicemente appoggiato. Proposta in pelle o tessuto, Alpilles è disponibile sia con un unico rivestimento sia con due diversi rivestimenti per la parte anteriore e quella posteriore della poltrona, offrendo così un'ampia possibilità di personalizzazione e di inserimento nei più disparati ambienti domestici e dell'hospitality.

In name and shape, the Alpilles chaise longue recalls the profile of the mountainous scenery of the South of France, as well as the modern culture from which the style of this comfortable and elegant type of armchair emerges. Interpreting the theme in a contemporary key, its design plays on the clear juxtaposition between two components: the sinuous padded monobloc of the seat-backrest and the load-bearing metal frame, on which the first is simply mounted. Available in leather or fabric, Alpilles comes both with a single piece of material or with two different pieces, one for the front and one for the back of the armchair, thus offering ample possibility for customization and insertion into the most disparate domestic and hospitality environments.

ALPILLES poltrona/armchair
design Fabrice Berrux

HARPE tavolino/coffee table
design Fabrice Berrux

BON TON sospensione/suspension lamp
Studio Team Design

330
331



ALPILLES poltrona/armchair
design Fabrice Berrux



Poltrone. Armchairs.

ALPILLES poltrona/armchair
design Fabrice Berrux

HARPE tavolino/coffee table
design Fabrice Berrux

BIO-S lampada da terra/floor lamp
Studio Team Design

JAZZ tavolino/coffee table
design Bonaldo Lab



Poltrone. Armchairs.

Globalove

Design Karim Rashid

Ispirata dall'idea di purezza e di riduzione all'essenziale delle forme, che richiamano idealmente quelle della "Madre Terra", la poltrona Globalove, disegnata da Karim Rashid, si distingue in particolare per la comoda e avvolgente seduta, dal profilo originale. Appoggiata a terra, la seduta assume la configurazione di una fascia circolare, che ingloba lo schienale e accoglie il cuscino.

Lo stile del design di Karim Rashid emerge anche negli accostamenti dei rivestimenti che possono essere a contrasto e ben caratterizzati ma capaci di integrarsi armonicamente con altri elementi d'arredo

Inspired by the idea of purity and the reduction of forms to the essential which ideally recall those of "Mother Earth", the Globalove armchair designed by Karim Rashid stands out in particular for its comfortable and enveloping seat and a highly original profile. Resting on the ground, the seat takes on the configuration of a circular band, which incorporates the backrest and houses the cushion.

Karim Rashid's design style also emerges in the combinations of covers which can be either contrasting and perfectly typical but also equally capable of integrating harmoniously with other furnishing elements.

GLOBALOVE poltrona/armchair
design Karim Rashid

DOGMA libreria/bookshelf
design Alain Gilles







Colibrì

Design Fabrice Berrux

Ampia e accogliente, Colibrì somma la leggerezza della monoscocca dalle forme organiche con il rigore dei dettagli, la flessuosità dello schienale alto con l'importanza delle dimensioni generose e inglobanti. Qualità di stile messe in risalto dalla accentuata linearità della base girevole a cinque razze, in un insieme che enfatizza il design-concept di "comfort senza gravità".

L'imbottitura della seduta e dello schienale e il rivestimento in tessuto accoppiato, che dona volume alla figura, esaltano anche visivamente il senso di morbidezza e comodità della poltrona, garantito dalla lavorazione trapuntata canneté.

La poltrona Colibrì è disponibile anche nella versione Colibrì soft, che prevede una diversa imbottitura ed una valorizzazione delle linee del progetto, interpretate con forme più morbide.

Wide and welcoming, Colibrì combines the lightness of the naturally-shaped monocoque shell with the rigour found in the details, the suppleness of the high backrest and the significantly generous and encompassing dimensions. These stylistic qualities are highlighted by the accentuated linearity of the five-spoke swivel base, giving an overall impression that emphasizes the design concept of "comfort without gravity".

The padding of the seat and backrest and the matching fabric covering, which gives volume to the figure, also visually enhance the armchair's sense of softness and comfort, an element guaranteed by the canneté quilting.

The Colibrì armchair is also available in the Colibrì soft version, which includes different padding and an enhancement of the design's lines, interpreted with softer shapes.

COLIBRÌ poltrona/armchair
design Fabrice Berrux

COLIBRÌ FOOTREST poggiapiedi/footrest
design Fabrice Berrux

ALIX libreria/bookshelf
design Maurizio e Silvia Varsi

INNESTI tavolino/coffee table
design Paolo Grasselli

340/
341



COLIBRÌ poltrona/armchair
design Fabrice Berrux

COLIBRÌ FOOTREST poggiapiedi/footrest
design Fabrice Berrux



COLIBRÌ poltrona/armchair
design Fabrice Berrux

COLIBRÌ FOOTREST poggiapiedi/footrest
design Fabrice Berrux



COLIBRÌ SOFT poltrona/armchair
design Fabrice Berrux



Poltrone. Armchairs.

COLIBRÌ SOFT poltrona/armchair
design Fabrice Berrux

COMBINATION tavolino/coffee table
design Alain Gilles

OPTIC libreria/bookshelf
design Marco Zito



Poltrone. Armchairs.

Bruno

Design Mauro Lipparini

Poliedrica e ricercata, la famiglia di poltrone Bruno reinterpreta lo stile e delle classiche aree relax della casa e dei luoghi di accoglienza del passato. Le forme curve e accoglienti, le generose imbottiture e la preziosa ricercatezza delle lavorazioni ne rendono l'immagine piacevolmente morbida, offrendo una resa estetica ben caratterizzata, accentuata da dettagli ricercati, come la bordatura continua dei braccioli e dello schienale. Proposta anche nella versione trapuntata (Bruno ego), la poltrona è disponibile in due diverse basi: con piedi in metallo o con base rivestita. Il rivestimento completamente sfoderabile è in tessuto oppure in pelle.

Multifaceted and sophisticated, the Bruno family of armchairs reinterprets the style of classic relaxation areas found in the homes and reception areas of the past. The curved and welcoming shapes, the generous padding and the precious elegance of the workmanship all make the image pleasingly soft, offering a clearly expressed aesthetic result that is highlighted by classic details, such as the continuous edging of the armrests and backrest. Also available in the quilted version (Bruno ego), the armchair comes with two different bases, either with metal feet or with an upholstered base. The completely removable cover is in fabric or leather.

BRUNO EGO poltrona/armchair
design Mauro Lipparini

PISA tavolino/coffee table
design Mauro Lipparini

ACQUERELLI lampada da terra/floor lamp
design Marco Zito

346/
347



BRUNO poltrona/armchair
design Mauro Lipparini



BRUNO poltrona/armchair
design Mauro Lipparini

COMBINATION tavolino/coffee table
design Alain Gilles

348 /
349



Bodo

Design Mauro Lipparini

Risultato di un'attenta rilettura stilistica dell'archetipo della classica poltroncina moderna, il design di Bodo si arricchisce dell'accostamento tra le proporzioni e le forme delle generose imbottiture e l'inserimento ricercato di piccoli dettagli significativi, come il sottile inserto che sottolinea il profilo dei braccioli, che ne rendono la figura ancora più domestica e familiare. Proposta nella versione fissa, con base a quattro piedi, oppure in versione girevole, Bodo è disponibile con il rivestimento in tessuto o pelle, sempre completamente sfoderabile.

The result of a careful stylistic rereading of the archetypal classic modern armchair, Bodo's design is enriched by the combination of the proportions and shapes of the generous padding and the elegant insertion of small yet significant details, such as the thin insert that underlines the profile of the armrests, making the image even more domestic and familiar. Available in both the fixed version with four-legged base or in the swivel version, Bodo has either a fabric or leather cover both of which are completely removable.

BODO poltrona/armchair
design Mauro Lipparini

SOFI lampada da terra/floor lamp
Studio Team Design

350/
351



BODO poltrona/armchair
design Mauro Lipparini

NARCISO specchio/mirror
design Marconato & Zappa

INNESTI tavolino/coffee table
design Paolo Grasselli



Nikos

Design Sergio Bicego



Astrazione delle linee e comfort evidente si incontrano nelle forme calibrate della poltrona Nikos, ideata per i più disparati ambienti domestici e dell'hospitality. Accogliente e confortevole, risulta particolarmente comoda grazie alle forme ergonomiche e al cuscino poggia-reni, che sostiene la zona lombare. Proposta anche nella versione con schienale alto (Nikos hi), caratterizzata da un'elegante trapuntatura, è dotata di rivestimento in tessuto o in pelle. Ampie anche la possibilità di personalizzazione della base in metallo verniciato, disponibile in diverse tonalità e finiture che consentono di comporre svariati abbinamenti tono su tono o a contrasto con la seduta. A completare la collezione c'è il Nikos footrest, utile sostegno da abbinare alla poltrona.

The abstraction of lines is combined with evident comfort in the carefully calibrated shapes of the Nikos armchair, designed for the most diverse domestic and hospitality environments. Welcoming and comfortable, it is particularly relaxing thanks to the ergonomic shapes and the lower back cushion which supports the lumbar area. Also available in the version with high backrest (Nikos hi) and characterized by elegant quilting, it comes with either fabric or leather upholstery. There is also a wide range of personalisation options for the painted metal base, available in a range of shades and finishes that allow you to create a number of different tones-on-tone or contrasting combinations with the seat. The collection is completed with the Nikos footrest, a useful support to match the armchair.

NIKOS HI poltrona/armchair
design Sergio Bicego

DORIAN credenza/sideboard
design Spazioameno

ACQUERELLI lampada da terra/floor lamp
design Marco Zito

354 /
355



NIKOS poltrona/armchair
design Sergio Bicego

ACQUERELLI lampada da terra/floor lamp
design Marco Zito

DORIAN credenza/sideboard
design Spazioameno

NIKOS HI poltrona/armchair
design Sergio Bicego

NIKOS FOOTREST poggiapiedi/footrest
design Sergio Bicego

ADONE specchio/mirror
design Marconato & Zappa



Pil armchair

Design Alessandro Busana

Pil armchair è una poltrona ispirata all'oggetto simbolo di morbidezza, il cuscino: solitamente vissuto come un accessorio è qui il protagonista, usato per dare forma a una poltrona che comunica senso di confort e relax. In Pil armchair il cuscino diventa un accogliente modulo per la seduta e lo schienale.

Il cuscino-seduta presenta una piega nel mezzo, creata per generare un effetto avvolgente che enfatizza, anche visivamente, la sensazione di morbidezza. La poltrona è proposta anche con schienale alto e proporzioni più generose, Pil armchair hi, e può essere abbinata ad un comodo poggiapiedi, Pil footrest.

The Pil armchair is inspired by the cushion, an object symbolizing softness. Usually seen as an accessory, here it takes centre stage, used to give shape to an armchair that communicates a sense of comfort and relaxation. As an integral part of the Pil armchair the cushion becomes a welcoming device for both the seat and the backrest.

The seat cushion has a fold in the middle, created to generate an enveloping effect that also emphasizes the sensation of softness on a visual level.

The armchair is also available with a high backrest and more generous proportions, Pil armchair hi, and can be combined with the comfortable Pil footrest.

PIL ARMCHAIR poltrona/armchair
design Alessandro Busana

KUMO tavolino/coffee table
design Mauro Lipparini

358 /
359



PIL ARMCHAIR poltrona/armchair
design Alessandro Busana

PIL FOOTREST poggiatesta/footrest
design Alessandro Busana

VERTIGO credenza/sideboard
design Dondoli e Poggi

PIL ARMCHAIR HI poltrona/armchair
design Alessandro Busana

KUMO tavolino/coffee table
design Mauro Lipparini

BIO-S lampada da terra/floor lamp
Studio Team Design



Saddle armchair

Design Giuseppe Viganò

Con la sua silhouette sinuosa e ammorbidita dall'imbottitura, Saddle armchair evoca la forma di una sella, interpretata in senso contemporaneo grazie ai piedi inclinati in metallo che ne alleggeriscono la figura. La poltrona è caratterizzata dalla sartorialità e dalla cura dei dettagli, che emerge nel particolare contrasto tra il rivestimento e l'insero all'interno dei braccioli, che può essere in tessuto o in pelle. L'accogliente schienale ha una linea slanciata: puro relax in chiave moderna. Il rivestimento è completamente sfoderabile.

Saddle armchair completa l'omonima linea di imbottiti, sinonimo di un'estetica contemporanea e funzionale, questo programma di arredo fa interagire tra loro un numero selezionato di elementi in un dialogo armonico immediatamente comprensibile.

A saddle-shaped upholstered element folded over on itself gives shape to the backrests and armrests and is the element that best identifies the Saddle sofa. It is an original and harmonious stylistic note which is underlined by the presence of a leather insert within the armrest. This in turn offers the possibility of changing colour and finish combinations with the sofa upholstery, which is available in fabric or leather.

The bathtub-shaped structure of the backrest and armrests and the fully upholstered seat give this sofa a welcoming image and highlight its contemporary stylistic value.

The possibility of combining various elements of the family gives rise to numerous configurations that can be inserted into a vast range of different environments.

SADDLE ARMCHAIR poltrona/armchair
design Giuseppe Viganò

LAKE specchio/mirror
design Gino Carollo

362
/ 363



SADDLE ARMCHAIR poltrona/armchair
design Giuseppe Viganò

LAKE specchio/mirror
design Gino Carollo

ANEMONE appendiabiti/coat stand
design Fabrice Berrux



Tirella, Tirella sofa

Design Paolo Grasselli

Dinamica e giocosa, la poltrona Tirella scaturisce dalla reinterpretazione di un classico stile retrò, che trae ispirazione dalle tirelle di tessuto adottate nei laboratori sartoriali. Ne scaturisce una silhouette originale, connotata dalla particolare forma dei cuscini, che abbracciano morbidamente la struttura metallica in corrispondenza dei braccioli e dello schienale. Un motivo accentuato dalla lavorazione che traccia un ritmo di scanalature accentuate, a contrasto con le geometrie essenziali della seduta monoblocco.

Tirella è una collezione di imbottiti dall'anima estremamente creativa, capace di sorprendere mescolando gli ingredienti in modo inedito: da questa idea nasce anche il divano Tirella sofa.

Dynamic and playful, the Tirella armchair is the result of the reinterpretation of a classic retro style which takes its inspiration from the swatches of fabric used in tailoring workshops. The result is an original silhouette, characterized by the particular shape of the cushions, which softly embrace the metal frame around the armrests and backrest. This motif is then highlighted by the workmanship that traces a rhythm of accentuated grooves, in contrast with the essential geometries of the single piece seat.

Tirella is a collection of upholstered furniture with a highly creative soul, capable of surprising by combining ingredients in a new way: the Tirella sofa was also born from this idea.

TIRELLA SOFA divano/sofa
design Paolo Grasselli

TIRELLA poltrona/armchair
design Paolo Grasselli

ARBOR tavolino/coffee table
design Dondoli e Pocci



TIRELLA SOFA divano/sofa
design Paolo Grasselli



Poltrone. Armchairs.

TIRELLA SOFA divano/sofa
design Paolo Grasselli

ARBOR tavolino/coffee table
design Dondoli e Poggi



368
369

Poltrone. Armchairs.

TIRELLA poltrona/armchair
design Paolo Grasselli



Poltrone. Armchairs.

TIRELLA poltrona/armchair
design Paolo Grasselli

PADDLE tavolino/coffee table
design Mauro Lipparini

370/
371



Poltrone. Armchairs.

Elementi apparentemente accessori nello scenario d'arredo contemporaneo, i pouf costituiscono in realtà l'indispensabile punteggiatura per orientare il senso della narrazione domestica e del comfort quotidiano. Bonaldo interpreta il tema sviluppando una collezione di pouf allo stesso tempo raffinati e complessi, che non si limitano a fungere da complementi rispetto ai più ampi elementi d'arredo. Materiali e colori, soluzioni di dettaglio e finiture si compattano nelle dimensioni per dare forma a veri concentrati di design, capaci di mettere in risalto sia gli arredi della zona giorno sia quelli della zona notte, nei più diversi contesti della casa e dell'hospitality.

Seemingly accessory elements in the contemporary furnishing scenario, poufs are actually indispensable punctuation marks by which to direct a sense of domestic narrative and daily comfort. Bonaldo interprets this theme by developing a collection of poufs that are both sophisticated and complex and which are not limited to acting as accessories for larger furnishing elements. Materials and colours, detail solutions and finishes are reduced in size to give shape to genuine examples of concentrated design, capable of highlighting furnishings in both the living area and the sleeping area in the most diverse contexts of the home and the hospitality world.

pouf/poufs

POUF/POUFS

BELT & CROSS	P. 378
CLESSIDRA	P. 394
INTRECCI	P. 402
LOVY POUF	P. 386
MARK	P. 398
NEUILLY POUF	P. 382
OLOS POUF	P. 374
SEKI	P. 390

Olos pouf

Design Mauro Lipparini

Elegante e raffinato nei dettagli, e nello stesso tempo domestico e familiare nella figura, il pouf imbottito Olos si trova a proprio agio con naturalezza e versatilità nei più disparati ambienti della casa e dell'hospitality, sia nella zona giorno sia nell'area notte. Le forme essenziali della parte imbottita del complemento, dal profilo leggermente arrotondato, sono ulteriormente valorizzate dal rivestimento in tessuto, pelle o ecopelle e dall'originale base in legno curvato a slitta (un particolare distintivo dell'intera collezione Olos), che accoglie, isola e protegge la seduta.

Elegant and refined in its details, and at the same time domestic and familiar in shape, the versatile Olos padded pouf is naturally at ease in the most disparate environments of the home and the hospitality sector, both in living and sleeping areas. The essential shapes of the accessory's padded section, with a slightly rounded profile, are further enhanced by the fabric, leather or eco-leather cover and the original curved sled wooden base (a distinctive detail of the entire Olos collection), which houses, isolates and protects the seat.

OLOS POUF pouf
design Mauro Lipparini

SOFI lampada da terra/floor lamp
Studio Team Design





Belt & Cross

Design Alain Gilles

La famiglia di pouf Belt & Cross comprende due elementi "gemelli", dalle differenti personalità. Accomunati dalla parte superiore imbottita, di forma essenziale, morbida e curvilinea, si distinguono con immediatezza fra loro per il basamento: rotondo e in metallo quello di Belt, in legno a forma di croce quello di Cross. Una soluzione stilistica originale e ricercata, che consente di "giocare" con la collocazione e il dialogo fra più elementi, per generare soluzioni d'arredo dinamiche e sempre differenti. Entrambi i pouf sono proposti con rivestimento in tessuto o pelle, in diverse varianti di trama e colore. Utilizzabili sia singolarmente che abbinati.

The Belt & Cross pouf family includes two "twin" elements with very different personalities. Sharing the padded upper section and an essential, soft and curved shape, they are immediately distinguished from each other by the base: the Belt base is round and made of metal while the Cross base is made of cross-shaped wood. This is an original and elegant stylistic solution, which allows you to "play" with the placement and dialogue between multiple elements, generating dynamic and ever changing furnishing solutions. Both poufs are available with fabric or leather covers and in different textures and colours, and they can also be used both individually or combined.

BELT pouf
design Alain Gilles

CROSS pouf
design Alain Gilles

378 /
379



BELT pouf
design Alain Gilles



Pouf. Poufs

BELT pouf
design Alain Gilles

CROSS pouf
design Alain Gilles



Pouf. Poufs

Neuilly pouf

Design Fabrice Berrux

Il design di Neuilly pouf gioca sul contrasto tra il volume generoso della porzione imbottita e la sottigliezza delle quattro gambe portanti metalliche, che costituiscono anche il tema conduttore di tutti gli elementi della collezione. Proposto in due diverse dimensioni e altezze, Neuilly pouf offre la possibilità di composizioni dinamiche e personalizzabili, sia negli spazi domestici, sia nelle zone di rappresentanza e negli spazi collettivi della casa, dell'hospitality e degli uffici. Realizzato con imbottitura a pianta rotonda, è disponibile con rivestimento in tessuto, pelle o ecopelle in diverse varianti e colori.

The design of the Neuilly pouf plays on the contrast between the generous volume of the padded portion and the slenderness of the four supporting metal legs, which also call to mind the underlying theme of all the elements in the collection. Available in two different sizes and heights, the Neuilly pouf offers the possibility of dynamic and personalised compositions, both in domestic spaces, corporate representative areas and in the collective spaces of the home, hospitality environments and offices. Made with circular padding, it is available with fabric, leather or eco-leather covers in different variations and colours.

NEUILLY POUF pouf
design Fabrice Berrux

PIN lampada da terra/floor lamp
design Dondoli e Pocci

FOIL libreria/bookshelf
design Maurizio e Silvia Varsi

382 /
383





Lovy pouf

Design Sergio Bicego

Immaginata come un'originale e ricercata reinterpretazione in chiave contemporanea del classico design anni Cinquanta e Sessanta, l'ampia famiglia di imbottiti Lovy comprende anche un dinamico pouf, ideale complemento del divano e della poltrona coordinati, oltre che elemento autonomo, utilizzabile anche come tavolino da salotto. Il versatile progetto di Sergio Bicego comprende due tipologie di pouf, distinte per la forma tonda o quadrata dell'alto e confortevole cuscino, e accomunate dall'elemento caratterizzante della struttura metallica a croce, enfatizzata dalle quattro gambe. Il rivestimento è in tessuto sfoderabile, disponibile in numerose varianti cromatiche.

Conceived as an original and sophisticated reinterpretation of the classic design of the 1950s and 1960s in a contemporary key, the large family of Lovy upholstered furniture also includes a dynamic pouf, an ideal complement to the coordinated sofa and armchair, as well as an independent element which can also be used as a living room coffee table. Sergio Bicego's versatile design includes two types of pouf, distinguished by the round or square shape of the high comfortable cushion, and notable for the typical element of the cross-shaped metal frame, emphasized by the four legs. The cover is in removable fabric and available in numerous different colours.

LOVY POUF pouf
design Sergio Bicego

KAOS libreria/bookshelf
design Mauro Lipparini

ACQUERELLI lampada da terra/floor lamp
design Marco Zito

386/
387



LOVY POUF pouf
design Sergio Bicego

KAOS libreria/bookshelf
design Mauro Lipparini



Pouf. Poufs

LOVY POUF pouf
design Sergio Bicego



Pouf. Poufs

Seki

Design Marconato e Zappa

Il pouf Seki è caratterizzato da linee morbide e irregolari, che ricordano quelle di sassi levigati dall'acqua, insieme alla qualità delle finiture e dei materiali. Un tema stilistico enfatizzato dal doppio rivestimento in pelle o tessuto: la parte inferiore a contatto con il pavimento ricorda la porzione "bagnata" della pietra, mentre quella superiore riproduce la trama e le sfaccettature della pietra stessa. Le sue forme, apparentemente irregolari per l'assenza di spigoli e di lati ortogonali, restituiscono un'immagine sempre differente secondo il punto di vista dell'osservatore, invitando a dare vita a paesaggi domestici disparati, idealmente senza fine.

The Seki pouf stands out for its soft and irregular lines, reminiscent of stones smoothed by water, as well as the quality of the finishes and materials. A stylistic theme emphasized by the two-piece cover in leather or fabric, the lower part in contact with the floor recalls the "wet" portion of the stone, while the upper part reproduces the texture and facets of the stone itself.

The shapes, apparently irregular due to the absence of edges and right angle sides, offer an image that is constantly changing depending on the observer's point of view, thereby presenting an invitation to give life to different and effectively endless domestic landscapes.



SEKI pouf
design Marconato & Zappa



Pouf. Poufs

SEKI pouf
design Marconato & Zappa

BACKDROP credenza/sideboard
design Alain Gilles

ACQUERELLI lampada da terra/floor lamp
design Marco Zito

392
/393



Pouf. Poufs

Clessidra

Design Mauro Lipparini

Esplicitamente ispirata all'archetipo omaggiato nel nome, oltre che nella forma, il pouf Clessidra è caratterizzato dalla silhouette sinuosa, concava nella parte centrale. Morbidezza e funzionalità lo rendono versatile e poliedrico, sia nella zona notte, come comodino nella camera da letto, oppure nella zona giorno, ad esempio come tavolino da affiancare al divano. Proposto con rivestimento in tessuto, può essere finito nella parte superiore in pelle, offrendo così la possibilità di realizzare soluzioni d'arredo molteplici e dinamiche, anche combinato in gruppo, accostando liberamente più elementi.

Explicitly inspired by the archetype referred to in the name as well as in the shape (since clessidra means hourglass in English), the Clessidra pouf has a sinuous silhouette which is concave in the central section. Softness and functionality make it versatile and multipurpose, both in the sleeping area, as a bedside table in the bedroom, or in the living area, for example as a coffee table to place alongside the sofa. Available with a fabric cover, the upper section can be finished in leather, thus offering the possibility of creating multiple and dynamic furnishing solutions, even in a group by freely combining several different elements.

CLESSIDRA pouf
design Mauro Lipparini

VENUS vanity
design Marconato & Zappa

394 /
395



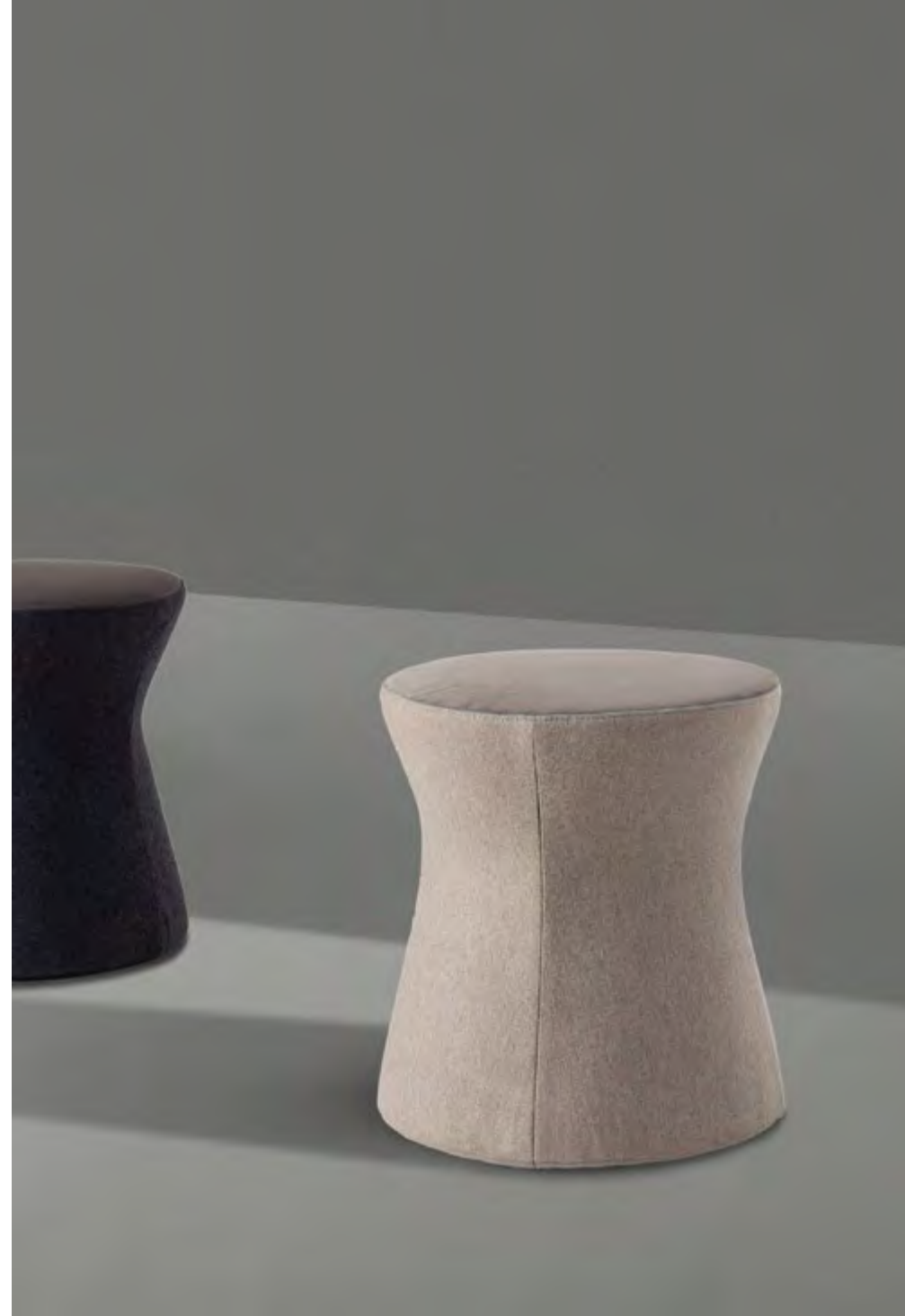

Mark

Design Bonaldo Lab

Vasta e versatile, la collezione di complementi per la zona giorno e per la zona notte Mark comprende un pouf e una panca coordinati, di diverse misure e proporzioni, con infinite potenzialità nell'arredo. Elemento caratterizzante è il motivo a righe con doppia cucitura ed inserto in pelle, che conferisce una specifica identità a tutti gli elementi e versioni, con varie soluzioni di finitura e rivestimento, sia tono su tono sia a contrasto. Dotati di una base in metallo dal disegno lineare e disponibili in numerose varianti cromatiche, tutti gli elementi della collezione sono proposti con rivestimento in tessuto o pelle, completamente sfoderabile.

Vast and versatile, the Mark collection of accessories for living and sleeping areas includes a coordinated pouf and bench of different sizes and proportions thereby giving infinite furnishing potential. The characterizing element is the striped motif with double stitching and leather insert which gives a specific identity to every element and version, yet with various finishes and covers available, both tone on tone and contrasting. Fitted with a linear design metal base and available in numerous different colours, all the elements of the collection come with completely removable fabric or leather covers.

MARK panca/bench
design Bonaldo Lab

MARK pouf
design Bonaldo Lab



MARK **panca/bench**
design Bonaldo Lab

MARK **pouf**
design Bonaldo Lab

Pouf, Poufs



MARK **pouf**
design Bonaldo Lab

400 /
401

Pouf, Poufs



Intrecci

Design Bonaldo Lab

Il pouf Intrecci unisce al rigore e all'essenzialità formale la ricercata cura di ogni elemento costruttivo e di finitura, con un'attenzione sartoriale al dettaglio. Il tema conduttore del progetto è costituito dalla particolare trama intrecciata del rivestimento sfoderabile, proposto in tessuto o in pelle, che si caratterizza come elegante motivo di decoro. Versatile e a proprio agio nei più disparati contesti dell'abitare e dell'hospitality, la famiglia Intrecci comprende diversi elementi coordinati (un pouf, proposto in tre diverse misure e un'elegante panca), che possono dare vita a innumerevoli e armoniche soluzioni d'arredo.

The Intrecci pouf combines rigour and essential formality with painstaking care applied to every manufactured and finishing element as well as sartorial attention to detail. The design's underlying theme is the particular woven texture of the removable cover, available in fabric or leather, which catches the eye as an elegant decorative motif. Versatile and at ease in the most disparate living and hospitality contexts, the Intrecci family features a number of coordinated elements including a pouf, available in three different sizes and an elegant bench, all of which can enhance countless harmonious furnishing solutions.

INTRECCI panca/bench
design Bonaldo Lab

INTRECCI pouf
design Bonaldo Lab



dati tecnici/technical data

DIVANI / SOFAS

ALIANTE	P. 406
BLEND	P. 410
BONAMOUR	P. 412
EVER MORE	P. 414
LARS	P. 416
LIAM	P. 418
LOVY HI, LOVY LOW	P. 422
MAXIMILIAN	P. 424
PANORAMA NEW	P. 428
PARAISO	P. 430
PEANUT B., PEANUT B.X.	P. 432
PHIL	P. 438
SADDLE	P. 442
SKID	P. 444
SOFT ISLAND	P. 446
SUPERHIRO	P. 448

POLTRONE / ARMCHAIRS

ALPILLES	P. 450
BODO	P. 450
BRUNO	P. 451
COLIBRÌ	P. 451
CROSS LOUNGE CHAIR	P. 452
GLOBALOVE	P. 452
KITAI	P. 453
LOCK	P. 453
LOVY ARMCHAIR	P. 454
NEUILLY LOUNGE	P. 454
NIKOS	P. 455
NOOR LOUNGE	P. 455
OLOS, OLOS BERGÈRE	P. 456
PIL ARMCHAIR	P. 456
SADDLE ARMCHAIR	P. 457
SLEEK	P. 457
TIRELLA, TIRELLA SOFA	P. 458

POUF / POUFS

BELT & CROSS	P. 459
CLESSIDRA	P. 459
INTRECCI	P. 460
LOVY POUF	P. 460
MARK	P. 461
NEUILLY POUF	P. 461
OLOS POUF	P. 462
SEKI	P. 462

ALIANTE



RIVESTIMENTO

Tessuto
Pelle
Completamente sfoderabile

IMBOTTITURA

Misto piuma
Fibra di poliestere
Poliuretano espanso

STRUTTURA

In legno con cinghie elastiche e supporti in metallo; giunzione tra gli elementi tramite meccanismo a forchetta.

COVER

Fabric
Leather
Fully removable cover

PADDING

Mixed feather
Polyester fiber
Polyurethane foam

FRAME

Wood with elastic strips and metal supports; joints between the components by means of "fork" mechanism.

PIEDI

Metallo
Bianco
Nero
Tortora
Supreme anthracite
Metallo Plus
Bronzo
Oro perlato
Piombo
Metallo Special
Clouded chrome
Brown nickel
Dark nickel

FEET

Metal
White
Black
Dove grey
Supreme anthracite
Plus metal
Bronze
Pearl gold
Lead
Special metal
Clouded chrome
Brown nickel
Dark nickel

DISEGNI - DRAWINGS

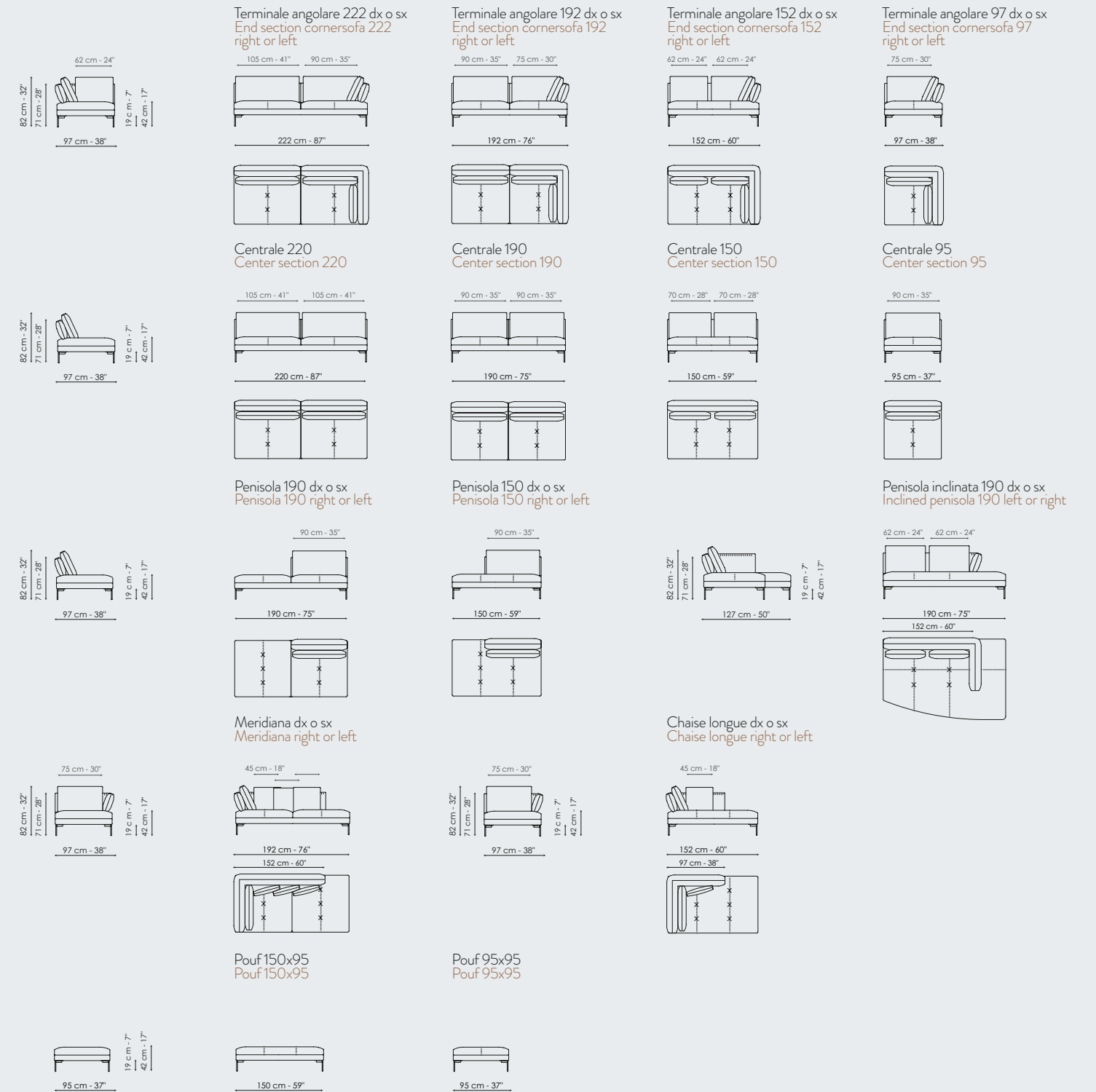
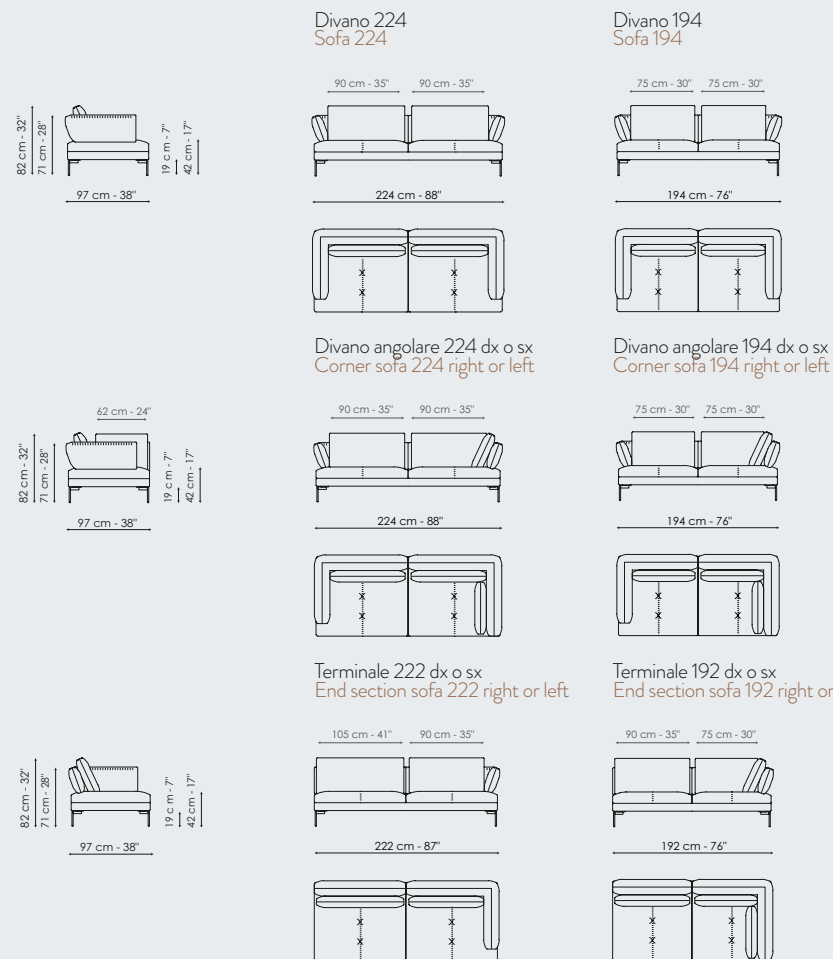

ALIANTE

TAVOLINO COFFEE TABLE



PIANO SUPERIORE

Legno impiallacciato
Noce Canaletto

PIANO INFERIORE

Legno impiallacciato
Noce Canaletto

UPPER TOP

Veneered wood
Canaletto walnut

LOWER TOP

Veneered wood
Canaletto walnut

PIEDI

Metallo
Bianco
Nero
Tortora
Supreme anthracite
Metallo Plus
Bronzo
Oro perlato
Piombo
Metallo Special
Clouded chrome
Brown nickel
Dark nickel

FEET

Metal
White
Black
Dove grey
Supreme anthracite
Plus metal
Bronze
Pearl gold
Lead
Special metal
Clouded chrome
Brown nickel
Dark nickel

DISEGNI - DRAWINGS

Tavolino 148x33
Coffee table 148x33

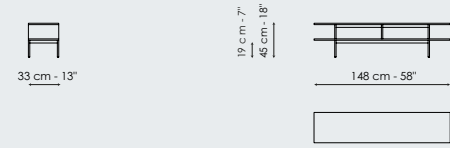

Tavolino 93x33
Coffee table 93x33

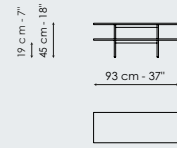

Tavolino 93x47
Coffee table 93x47



COMPOSIZIONI - COMBINATION

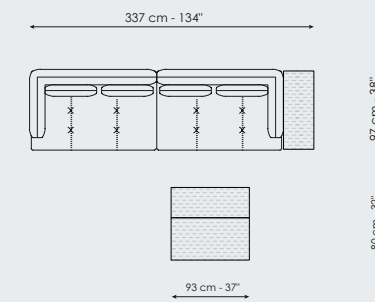

PAG. 100-101, 102, 103
Composizione 01 – terminale 152 sx, terminale 152 dx in tessuto MD15, piedi piombo + 2 tavolini 93 x 33 + tavolino 93 x 47 - piano noce Canaletto, piedi piombo / **Composizione 01** – end section sofa 152 left, end section sofa 152 right in MD15 fabric, lead feet + 2 coffee tables 93 x 33 + coffee table 93 x 47 - Canaletto walnut top, lead feet

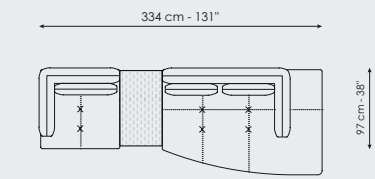

PAG. 107, 108-109
Composizione 02 – terminale 97 sx, penisola inclinata dx in tessuto SP69, piedi bronzo + tavolino 93 x 47 – piano noce Canaletto, piedi bronzo / **Composizione 02** – end section sofa 97 left, right inclined peninsula in SP69 fabric, bronze feet + coffee table 93 x 47 - Canaletto walnut top, bronze feet

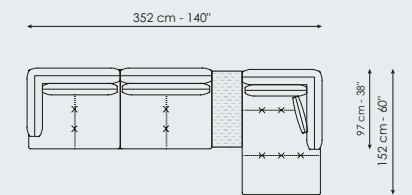

Composizione 03 – terminale 222 sx + tavolino 93 x 33 + chaise longue dx / **Composizione 03** – end section sofa 222 left + coffee table 93 x 33 + chaise longue right

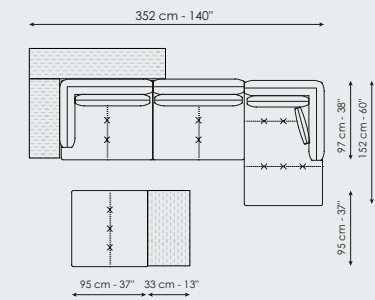

PAG. 95, 96-97, 98, 99
Composizione 04 – terminale 222 sx, chaise longue dx + pouf 95 x 95 in tessuto SP47, piedi bronzo + tavolino 93 x 33 + tavolino 148 x 33 + tavolino 93 x 47 - piano noce Canaletto, piedi bronzo / **Composizione 04** – end section sofa 222 left, chaise longue right + pouf 95 x 95 in SP47 fabric, bronze feet + coffee table 93 x 33 + coffee table 148 x 33 + coffee table 93 x 47 - Canaletto walnut top, bronze feet

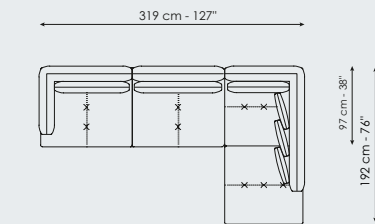

Composizione 05 – terminale 222 sx, meridiana sx / **Composizione 05** – end section sofa 222 left, meridiana left

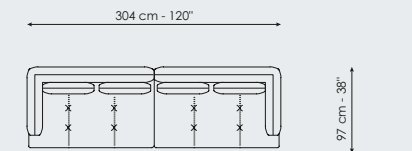

PAG. 104-105
Composizione – terminale 152 sx, terminale 152 dx in tessuto SP53, piedi piombo / **Composizione** – end section sofa 152 left, end section sofa 152 right in SP53 fabric, lead feet

BLEND



RIVESTIMENTO

Tessuto
Completamente sfoderabile

SCHIENALI

Cuoio
F07 nero
F08 rosso mattone
F10 testa di moro
F14 grigio scuro
F19 grigio chiaro
F21 sabbia
F22 fango

IMBOTTITURA

Fibra di poliestere
Poliuretano espanso

COVER

Fabric
Fully removable cover

BACKREST

Emery leather
F07 black
F08 brick red
F10 dark brown
F14 dark grey
F19 light grey
F21 sand
F22 mud

PADDING

Polyester fiber
Polyurethane foam

STRUTTURA

In legno per la seduta, in metallo per gli schienali; giunzione tra gli elementi tramite meccanismo a forchetta.

PIEDI

Metallo
Bianco
Nero
Tortora
Supreme anthracite
Metallo Plus
Bronzo
Oro perlato
Piombo
Metallo Special
Clouded chrome
Brown nickel
Dark nickel

FRAME

In wood for the seat, in metal for the backrest; connection between the elements by means of a "fork" mechanism.

FEET

Metal
White
Black
Dove grey
Anthracite grey
Plus metal
Bronze
Pearl gold
Lead
Special metal
Clouded chrome
Brown nickel
Dark nickel

Chaise longue 110x170 dx o sx
Chaise longue 110x170 right or left

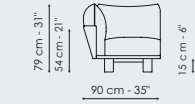
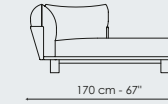
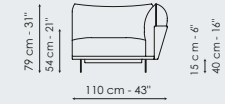

Angolo 90x90
Corner 90x90

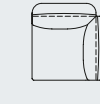
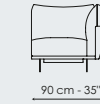

Pouf 75x75
Pouf 75x75

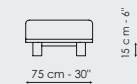

DISEGNI - DRAWINGS

Divano 260
Sofa 260

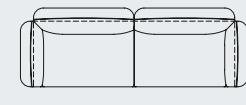
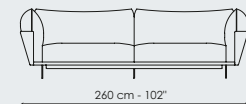
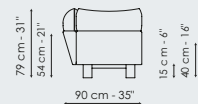

Terminale 245 dx o sx
End section sofa 245 right or left

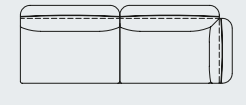
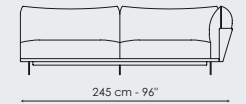
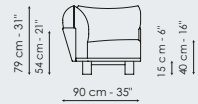

Chaise longue 130x170 dx o sx
Chaise longue 130x170 right or left

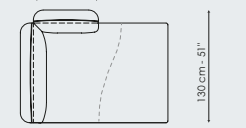
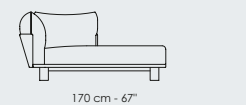
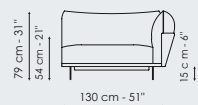

Divano 240
Sofa 240

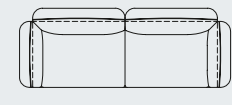
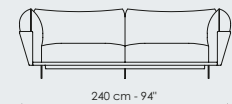

Terminale 225 dx o sx
End section sofa 225 right or left

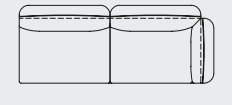
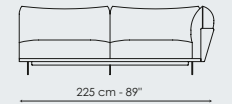

Chaise longue 120x170 dx o sx
Chaise longue 120x170 right or left

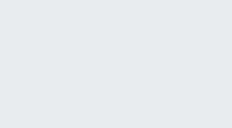
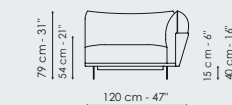

Divano 220
Sofa 220

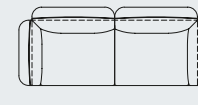
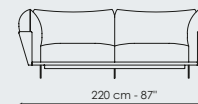

Terminale 205 dx o sx
End section sofa 205 right or left

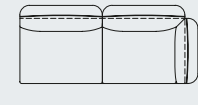
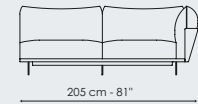

Chaise longue 120x170 dx o sx
Chaise longue 120x170 right or left

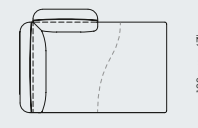
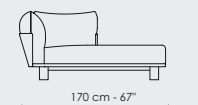

COMPOSIZIONI - COMBINATION

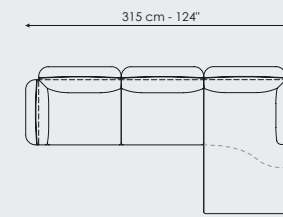

Composizione 01 – terminale 205 sx, chaise longue 170 x 110 dx / Composition 01 – end section sofa 205 left, chaise longue 170 x 110 right

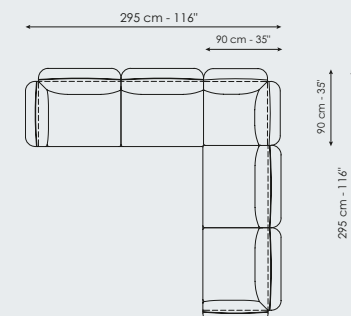

Composizione 04 – terminale 205 sx, angolo 90 x 90, terminale 205 dx / Composition 04 – end section sofa 205 left, corner 90 x 90, end section sofa 205 right

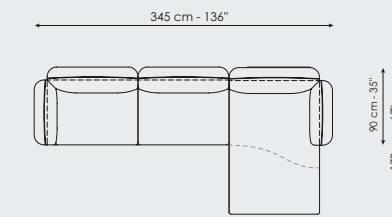

PAG. 116, 117, 118-119, 120-121
Composizione 02 – terminale 225 sx, chaise longue 170 x 120 dx con schienali in cuoio F10 e rivestimento in tessuto SP31, piedi bronzo / Composition 02 – end section sofa 225 left, chaise longue 170 x 120 right with backrest in F10 emery leather and SP31 fabric cover, bronze feet

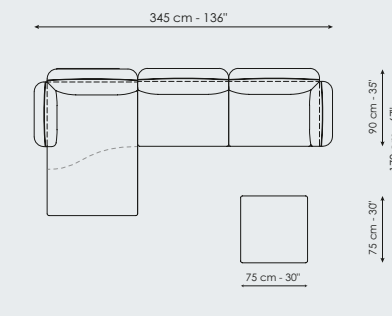

Composizione 05 – chaise longue 170 x 120 sx, terminale 225 dx + pouf 75 x 75 / Composition 05 – chaise longue 170 x 120 left, end section sofa 225 right + pouf 75 x 75

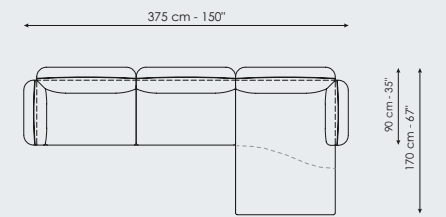

Composizione 03 – terminale 245 sx, chaise longue 170 x 130 dx / Composition 03 – end section sofa 245 left, chaise longue 170 x 130 right

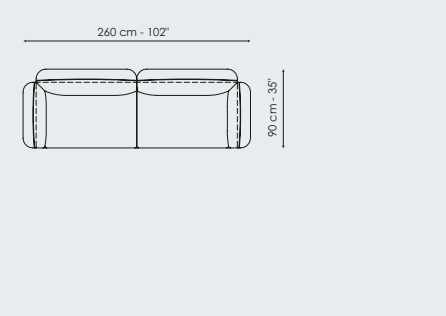

PAG. 111, 112, 113, 114-115
Composizione – divano 260 con schienali in cuoio F10 e rivestimento in tessuto SP52, piedi bronzo / Composition – sofa 260 with backrest in F10 emery leather and SP52 fabric cover, bronze feet

BONAMOUR



RIVESTIMENTO

Tessuto
Completamente sfoderabile

IMBOTTITURA

Misto piuma
Fibra di poliestere
Poliuretano espanso

STRUTTURA

Legno e conglomerato di legno;
giunzione tra gli elementi tramite
meccanismo a forchetta.

COVER

Fabric
Fully removable cover

PADDING

Mixed feather
Polyester fiber
Polyurethane foam

FRAME

Wood and wood chipboard; joints
between the various components by
means of "fork" mechanism.

PIEDI

Metallo
Nero

FEET

Metal
Black

DISEGNI - DRAWINGS

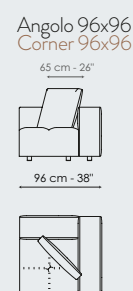
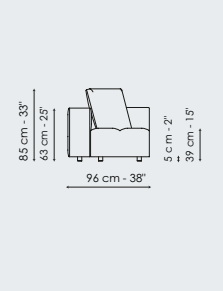
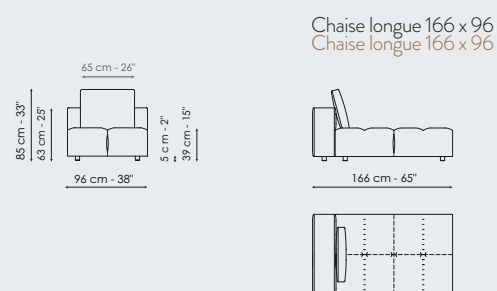
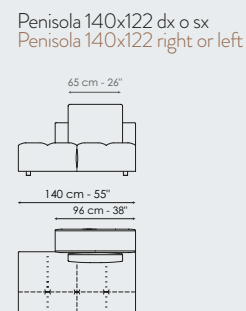
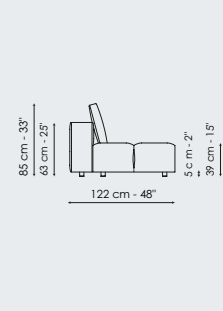
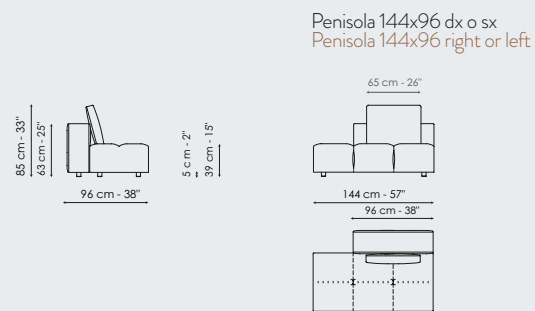
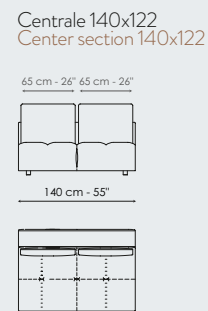
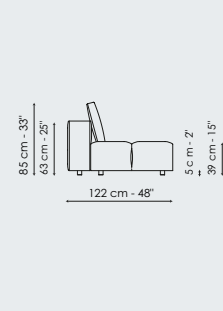
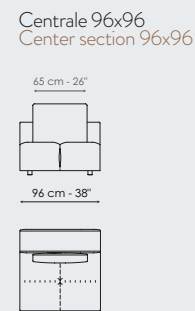
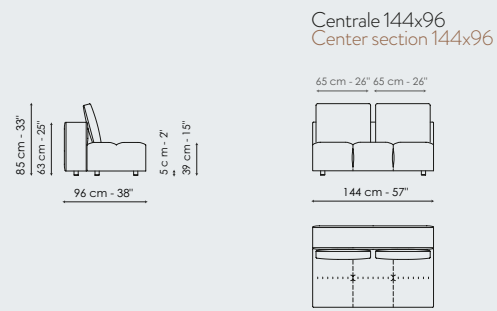

Penisola 140x96
Penisola 140x96

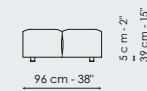

Penisola 144x70
Penisola 144x70

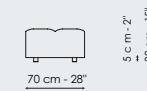

Penisola 96x70
Penisola 96x70



Pouf 140x96
Pouf 140x96

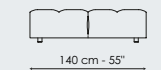
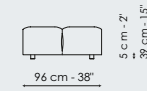

Pouf 144x70
Pouf 144x70

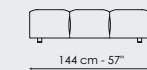

Pouf 96x70
Pouf 96x70



Schienale 144xH63
Backrest 144xH63

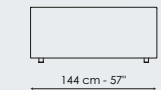
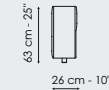

Schienale 140xH63
Backrest 140xH63

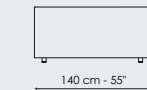
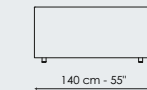

Schienale 96xH63
Backrest 96xH63

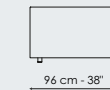
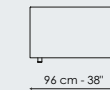

Schienale 96xH53
Backrest 96xH53

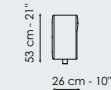

COMPOSIZIONI - COMBINATION

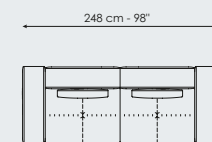

PAG. 60, 61
Composizione 01 - 2 braccioli 96, 2 centrali 96x96 in tessuto SP51, piedi neri /
Composizione 01 - 2 armrests 96, 2 center sections 96x96 in SP51 fabric, black feet

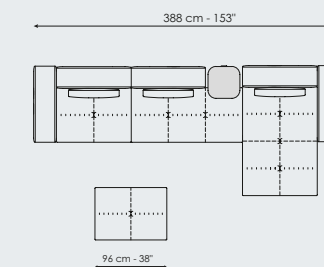

PAG. 45, 46-47, 48, 49, 50-51
Composizione 02 - bracciolo 96, centrale 96x96, penisola 144x96 sx, chaise longue, bracciolo 96 in tessuto SP53, piedi neri + Pouf 96x70 in tessuto SP53, piedi neri + Paddle 40 /
Composizione 02 - armrest 96, center section 96x96, left peninsula 144x96, chaise longue, armrest 96 in SP53 fabric, black feet + pouf 96x70 in SP53 fabric, black feet + Paddle 40

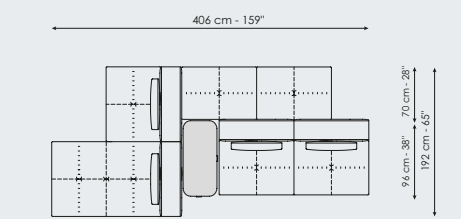

PAG. 53, 54-55, 56-57, 58, 59
Composizione 03 - 3 centrali 96x96, 2 penisola 96x70, chaise longue in tessuto SP51, piedi neri + Paddle 96 /
Composizione 03 - 3 center sections 96x96, 2 penisola 96x70, chaise longue in SP51 fabric, black feet + Paddle 96

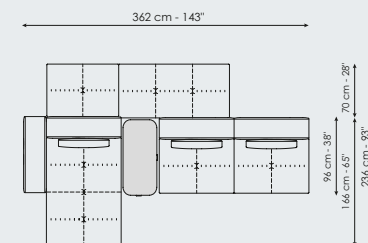

Composizione 04 - bracciolo 96, chaise longue, 2 centrali 96x96, penisola 96x70, penisola 144x70 + Paddle 96 /
Composizione 04 - armrest 96, chaise longue, 2 center sections 96x96, penisola 96x70, penisola 144x70 + Paddle 96

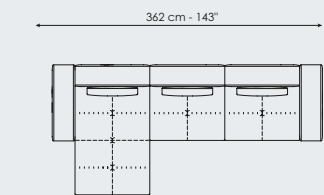

Composizione 05 - 2 braccioli 96, chaise longue, 2 centrali 96x96 /
Composizione 05 - 2 armrests 96, chaise longue, 2 center sections 96x96

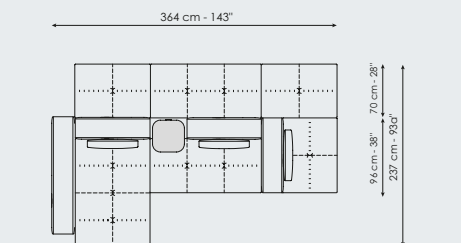

Composizione 06 - schienale 144, chaise longue, penisola 144x96 dx, centrale 96x96, 2 penisola 96x70, penisola 144x70 + Paddle 40 /
Composizione 06 - backrest 144, chaise longue, penisola 144x96 dx, center section 96x96, 2 penisola 96x70, penisola 144x70 + Paddle 40

EVER MORE



RIVESTIMENTO

Tessuto
Pelle
Completamente sfoderabile

IMBOTTITURA

Misto piuma
Fibra di poliestere
Poliuretano espanso

STRUTTURA

In legno e conglomerato di legno con cinghie elastiche, supporti in materiale plastico; giunzione tra gli elementi tramite meccanismo a forchetta.

COVER

Fabric
Leather
Fully removable cover

PADDING

Mixed feather
Polyester fiber
Polyurethane foam

FRAME

In wood and wood chipboard with elastic straps, supports in plastic material; connection between the elements by means of a "fork" mechanism.

PIEDI

Metallo
Bianco
Nero
Tortora
Supreme anthracite
Metallo Plus
Bronzo
Oro perlato
Piombo
Metallo Special
Clouded chrome
Brown nickel
Dark nickel

FEET

Metal
White
Black
Dove grey
Supreme anthracite
Plus metal
Bronze
Pearl gold
Lead
Special metal
Clouded chrome
Brown nickel
Dark nickel

DISEGNI - DRAWINGS

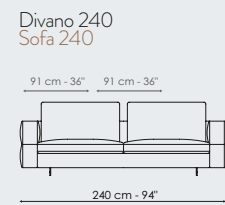
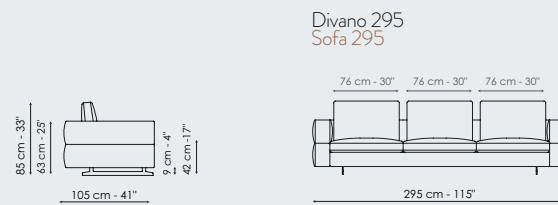

Terminale 275 dx o sx
End section sofa 275 right or left

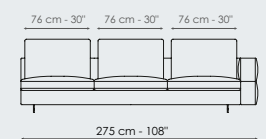

Terminale 220 dx o sx
End section sofa 220 right or left

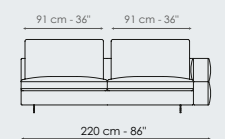

Divano 190 dx o sx
End section sofa 190 right or left

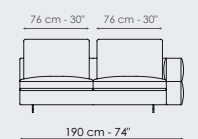

Divano angolare 295 dx o sx
Corner sofa 295 right or left

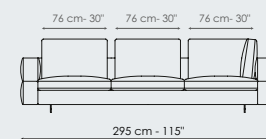

Divano angolare 240 dx o sx
Corner sofa 240 right or left

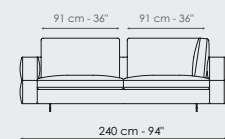

Semiangolo
Semi-corner

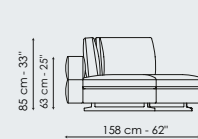

Semiangolo
Semi-corner

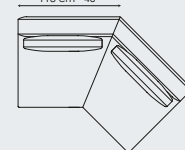
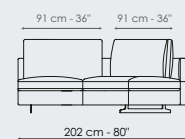

Terminale angolare 275 dx o sx
End section sofa 275 right or left

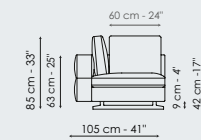

Terminale angolare 220 dx o sx
End section sofa 220 right or left

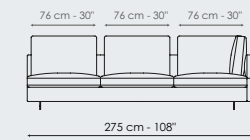

Terminale angolare 120 dx o sx
End section sofa 120 right or left

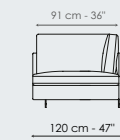

Centrale 255
Center section 255

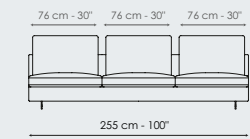

Centrale 200
Center section 200

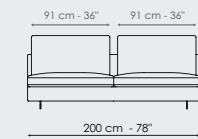

Centrale 170
Center section 170

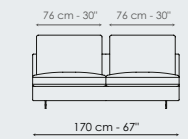

Chaise longue dx o sx
Chaise longue right or left

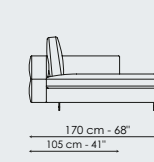

Meridiana dx o sx
Meridiana right or left

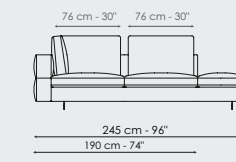

Angolo 105x105
Corner 105x105

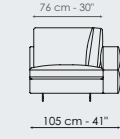

Pouf 105x85
Pouf 105x85

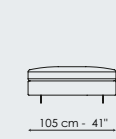

Pouf 160x55
Pouf 160x55

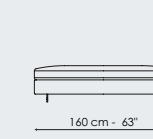

Pouf 105x55
Pouf 105x55

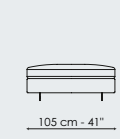

COMPOSIZIONI - COMBINATION

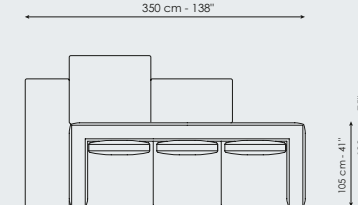

PAG. 158, 159, 160-161
Composizione 01 – divano 295 + pouf 160 x 55 + pouf 105 x 55 + pouf 105 x 85 in tessuto MD21, piedi bronzo /
Composizione 01 – sofa 295 + pouf 160 x 55 + pouf 105 x 55 + pouf 105 x 85 in MD21 fabric, bronze feet

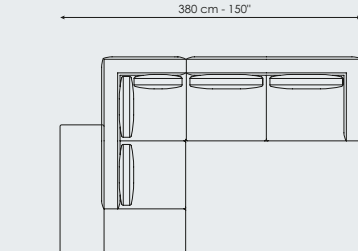

PAG. 162, 163, 164-165
Composizione 02 – meridiana dx, terminale 220 dx + pouf 160 x 55 in tessuto SP51, piedi piombo /
Composizione 02 – meridiana right, end section sofa 220 right + pouf 160 x 55 in SP51 fabric, lead feet

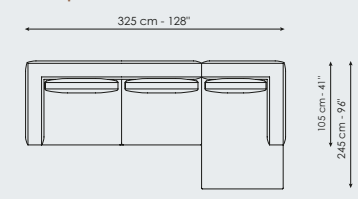

Composizione 04 – terminale 220 sx, chaise longue dx /
Composizione 04 – end section sofa 220 left, chaise longue right

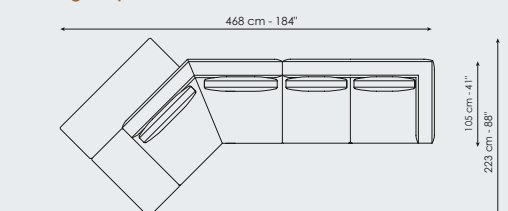

PAG. 167, 168-169
Composizione – terminale 190 dx, semiangolo, pouf 105 x 55, pouf 160 x 55 in tessuto SP51, piedi piombo /
Composizione – end section sofa 190 right, semi-corner, pouf 105 x 55, pouf 160 x 55 in SP51 fabric, lead feet

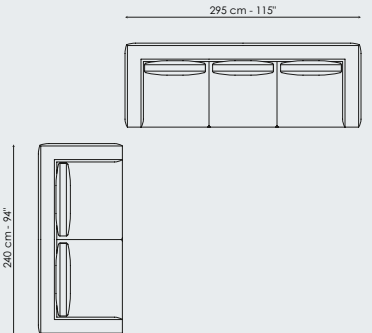

PAG. 153, 154-155, 156-157
Composizione – divano 295 + divano 240 in tessuto SP53, piedi piombo /
Composizione – sofa 295 + sofa 240 in SP53 fabric, lead feet

LARS



RIVESTIMENTO

Tessuto
Pelle
Completamente sfoderabile

IMBOTTITURA

Misto piuma
Fibra di poliestere
Poliuretano espanso

STRUTTURA

In legno e conglomerato di legno con cinghie elastiche; giunzione tra gli elementi tramite meccanismo a forchetta.

COVER

Fabric
Leather
Fully removable cover

PADDING

Mixed feather
Polyester fiber
Polyurethane foam

FRAME

Wood and wood chipboard; joints between the various components by means of "fork" mechanism.

PIEDI / BASE SAGOMATA

Metallo
Bianco
Nero
Tortora
Supreme anthracite
Metallo Plus
Bronzo
Oro perlato
Piombo
Metallo Special
Clouded chrome
Brown nickel
Dark nickel

FEET / SHAPED BASE

Metal
White
Black
Dove grey
Supreme anthracite
Plus metal
Bronze
Pearl gold
Lead
Special metal
Clouded chrome
Brown nickel
Dark nickel

DISEGNI - DRAWINGS

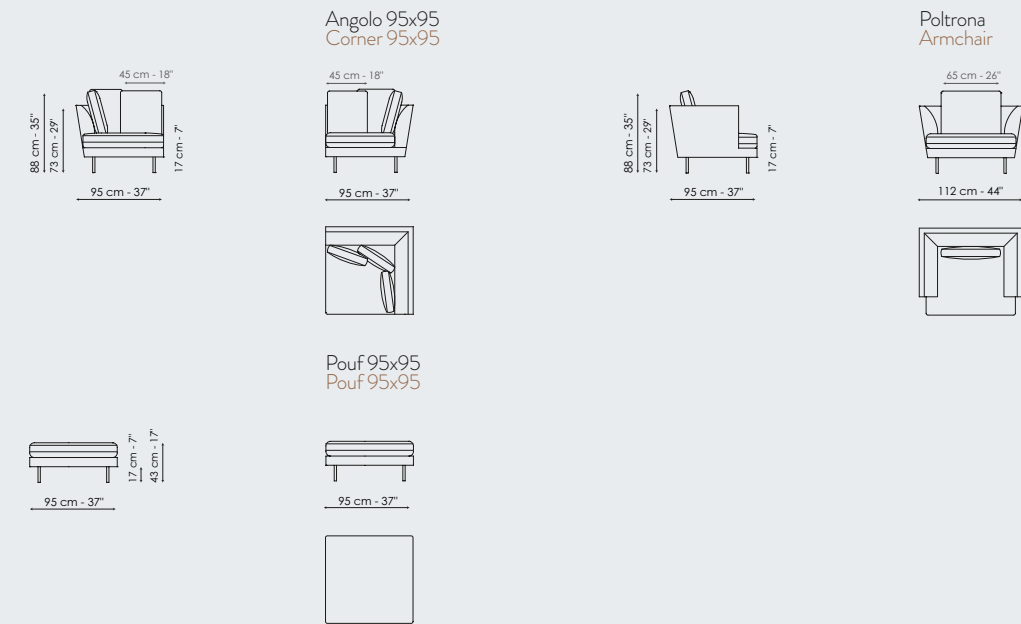
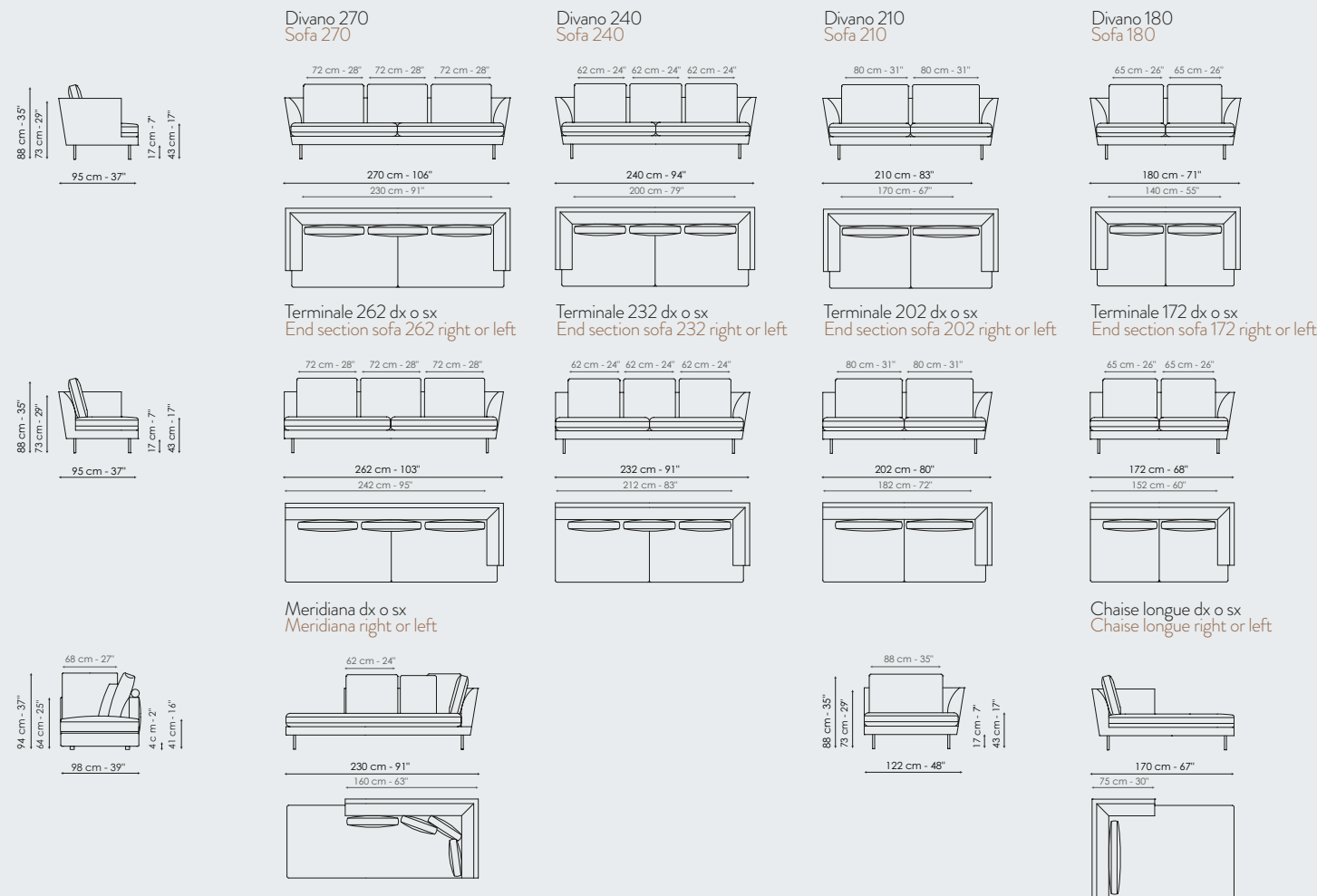

COMPOSIZIONI - COMBINATION

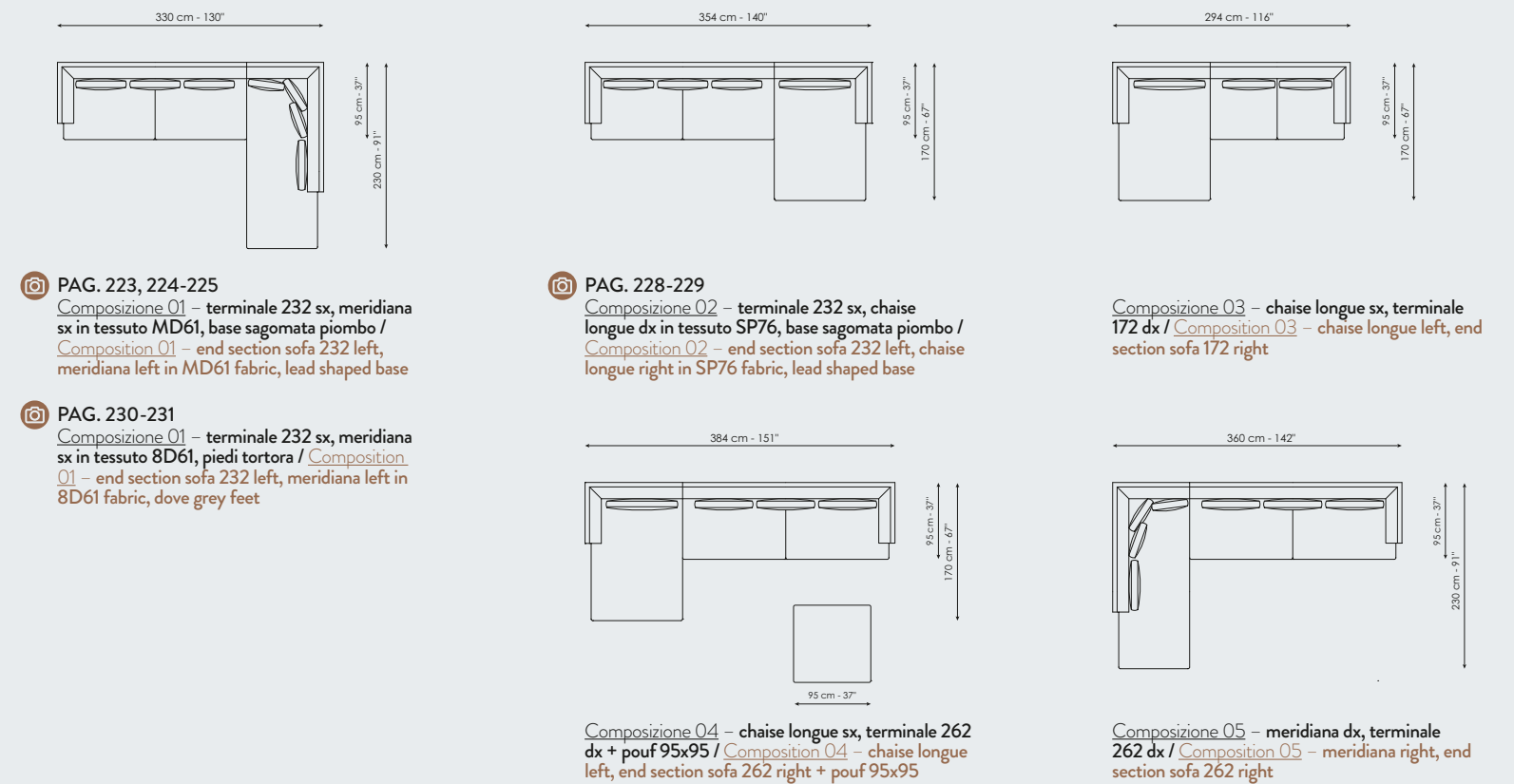

LIAM



RIVESTIMENTO

Tessuto
Pelle
Completamente sfoderabile

Su richiesta BORDO ORNAMENTALE

Colori disponibili
Grigio antracite
Grigio chiaro
Marrone
Nocciola
Sabbia

IMBOTTITURA

Misto piuma
Fibra di poliestere
Poliuretano espanso

COVER

Fabric
Leather
Fully removable cover

On request DECORATIVE PIPING

Available colours
Anthracite grey
Light grey
Brown
Hazel
Sand

PADDING

Mixed feather
Polyester fiber
Polyurethane foam

STRUTTURA

Struttura in legno; giunzione tra gli elementi tramite staffe metalliche.

PIEDI

Metallo
Nero

BRACCIOLO PORTA RIVISTE, BRACCIOLO, TAVOLINO, VASSOIO

Cuoio

F07 nero
F08 rosso mattone
F10 testa di moro
F14 grigio scuro
F19 grigio chiaro
F21 sabbia
F22 fango

FRAME

Wooden structure; joint between elements by means of metal brackets.

FEET

Metal
Black

MAGAZINE HOLDER ARMREST, ARMREST, COFFEE TABLE, TRAY

Emery leather

F07 black
F08 brick red
F10 dark brown
F14 dark grey
F19 light grey
F21 sand
F22 mud

DISEGNI - DRAWINGS

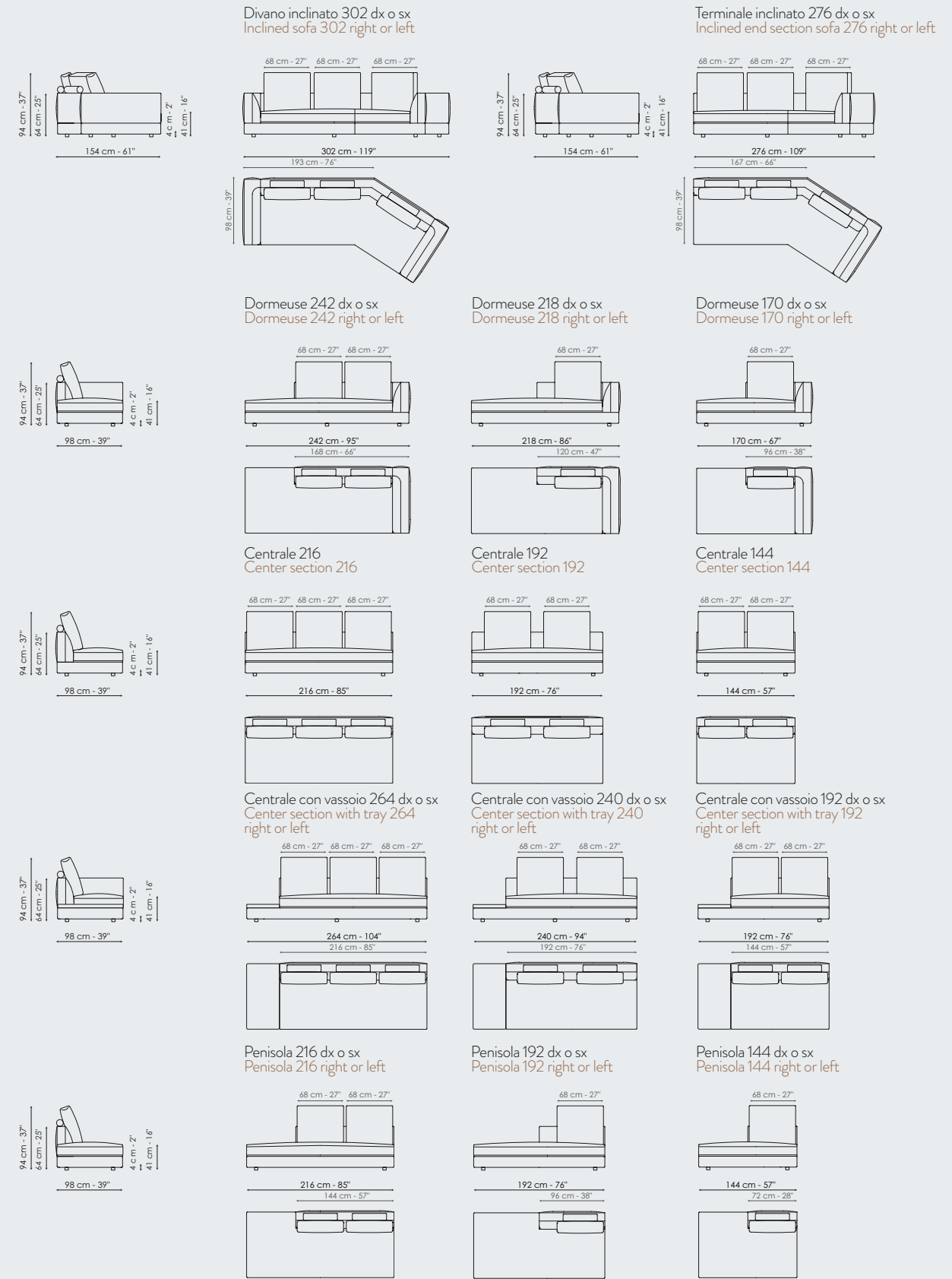
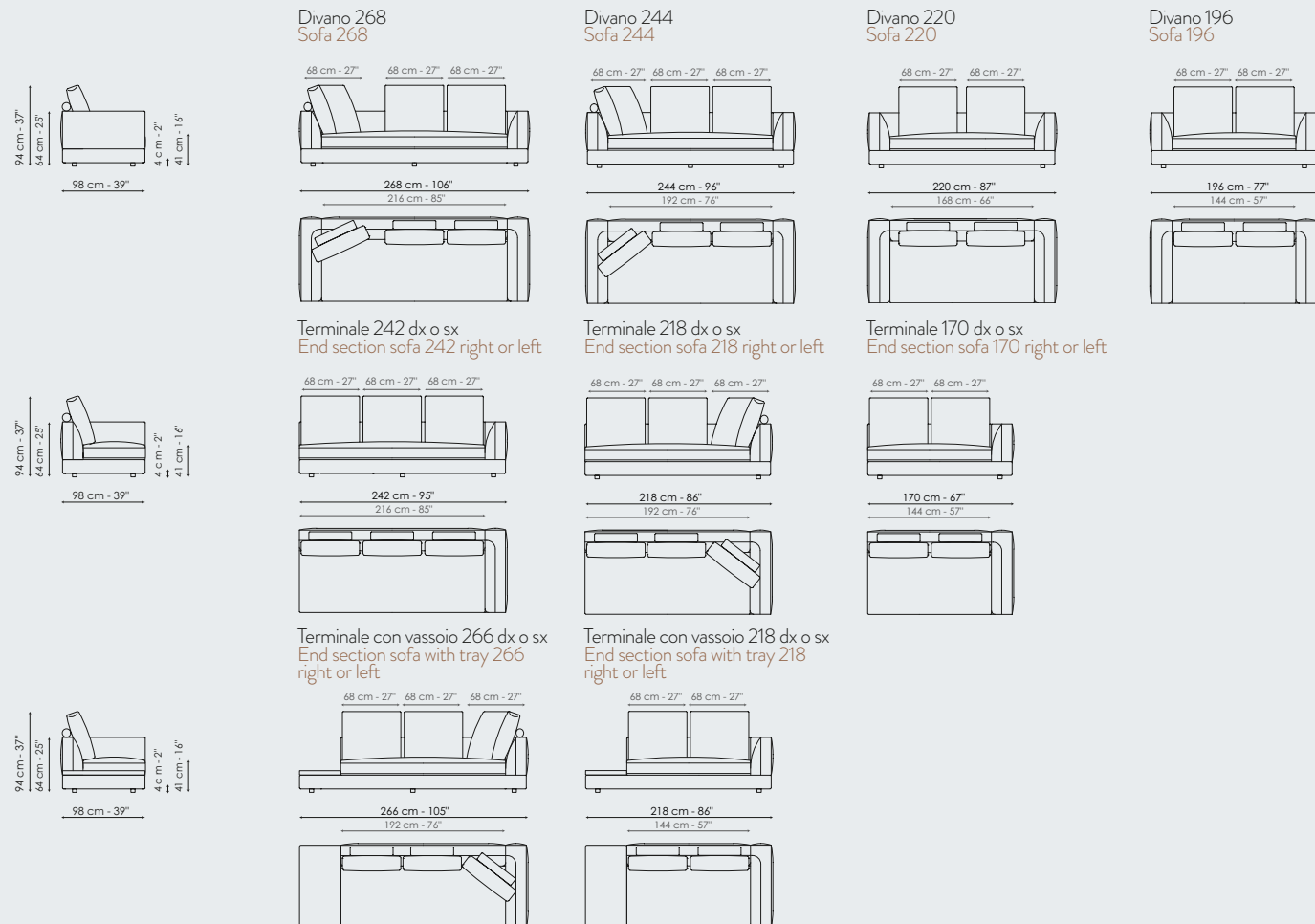

Meridiana 242 dx o sx
Meridiana 242 right or left

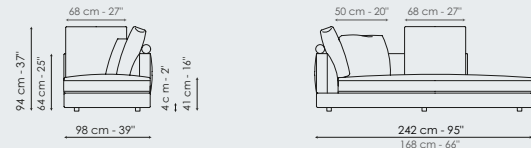

Chaise longue 170x98 dx o sx
Chaise longue 170x98 right or left



Chaise longue 170x120 dx o sx
Chaise longue 170x120 right or left

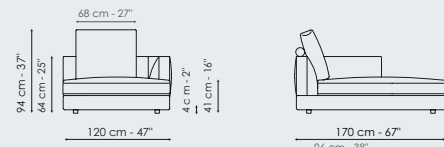

Chaise large 218x96
Chaise longue 218x96

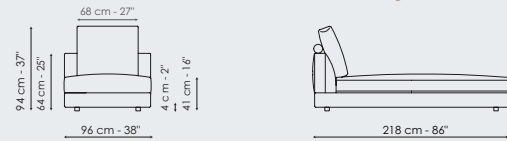

Chaise large 170x120
Chaise large 170x120

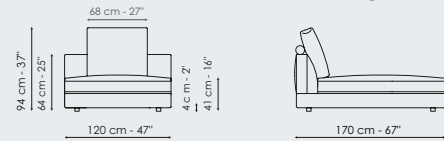

Bracciolo porta riviste
Magazine holder armrest

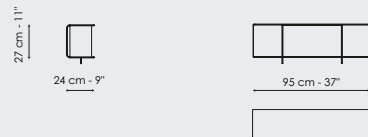

Tavolino
Coffee table

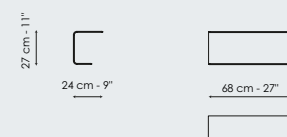

Bracciolo 116
Armrest 116

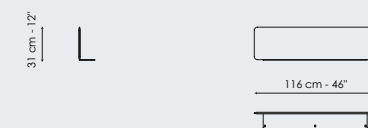

Bracciolo 68
Armrest 68

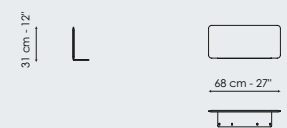

COMPOSIZIONI - COMBINATION

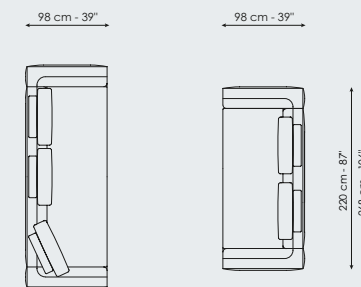

PAG. 23, 24-25, 26, 27
Composizione 01 - divano 268 + divano 220 in tessuto 9B67, bordo ornamentale grigio antracite, piedi neri / Composizione 01 - sofa 268 + sofa 220 in 9B67 fabric, anthracite grey decorative piping, black feet

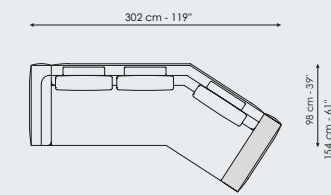

PAG. 28-29, 30, 31
Composizione 02 - divano inclinato 302 dx in pelle C10, con bracciolo porta riviste in cuoio F10, piedi neri / Composizione 02 - inclined sofa 302 right in C10 leather, with magazine holder armrest in F10 emery leather, black feet

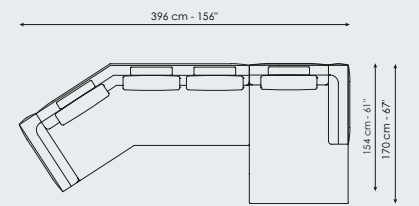

PAG. 33, 34-35, 36, 37
Composizione 03 - terminale inclinato 276 sx, chaise longue 170x120 dx in tessuto SP65, piedi neri / Composizione 03 - inclined end section sofa 276 left, chaise longue 170x120 right in SP65 fabric, black feet

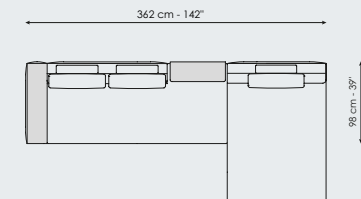

PAG. 39, 40-41, 42, 43
Composizione 04 - dormeuse 242 sx, chaise large 170x120 in tessuto MD82, con tavolino e bracciolo porta riviste in cuoio F10, piedi neri / Composizione 04 - dormeuse 242 left, chaise large 170x120 in MD82 fabric, with coffee table and magazine holder armrest in F10 emery leather, black feet

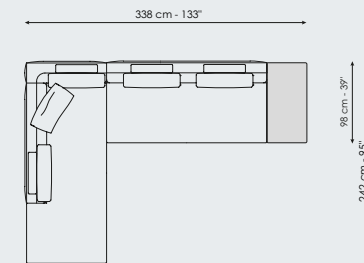

Composizione 05 - meridiana 242 dx, terminale con vassoio 240 dx / Composizione 05 - meridiana 242 right, end section sofa with tray 242 right

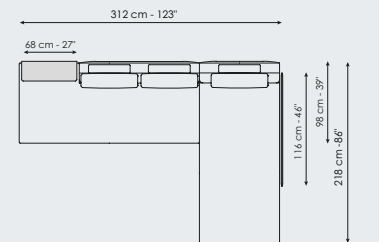

Composizione 06 - penisola 216 dx, tavolino, chaise large 216x96, bracciolo 116 / Composizione 06 - peninsula 216 right, coffee table, chaise large 216x96, armrest 116

ITALIER