

tablet

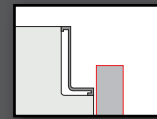

Neck



Bridge



Head



ANTA:
DOOR:

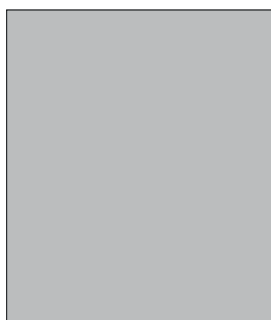

SP:
TH: **18** MM



Head

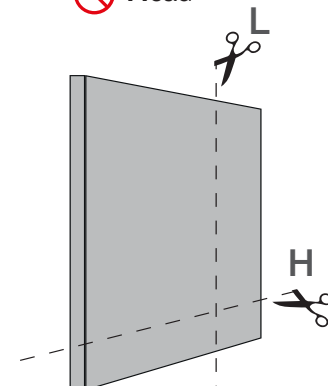

ANTA SP.18 MM
ABBINABILE CON:
TH. 18 MM DOOR
MATCHABLE WITH:



CONSULTA:
CONSULT:



ALTRO:
MORE:





bianco opz. 7447N
 porcellana opz. 7703N
 desert opz. 8914N
 seta antica opz. 7709
 brina opz. 9656
 monumento opz. 9657

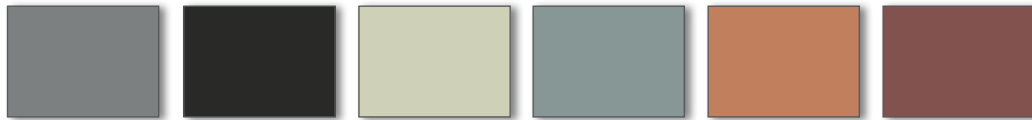

uragano opz. 9658
 nero opz. 7864
 verde giada opz. 8915
 verde rugiada opz. 8404
 corniola opz. 8125
 rosso minio opz. 8124

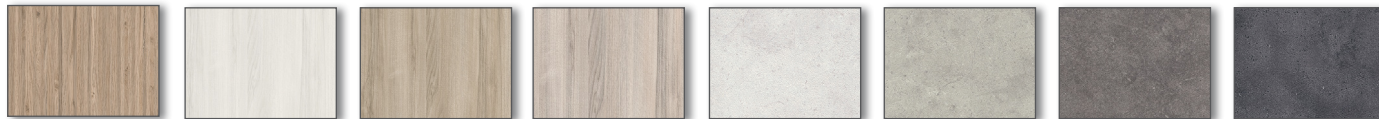

nativo opz. 4601
 ghiaccio opz. 2372
 barrique opz. 2374
 nuvola opz. 2373
 sale opz. 7451
 rena opz. 7708
 roccia opz. 8877
 piombo opz. 9649

Melaminico "Fascia 1"

Melamine "Band 1"

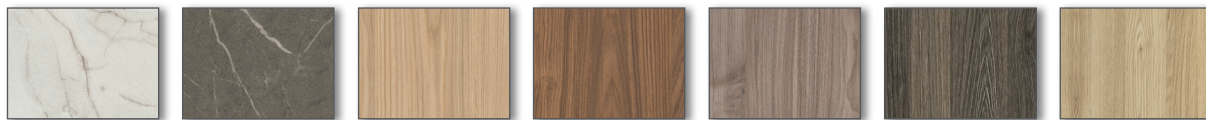

marmo white yule opz. 9645
 marmo venato grigio opz. 8870
 olio opz. 5323
 botte opz. 5324
 brown opz. 2371
 tabià opz. 5309
 ortisei opz. 5305



silver opz. 9654
 bronze opz. 9655
 caravella dark opz. 8876
 caravella light opz. 8875
 miele opz. 8215
 cognac opz. 8878

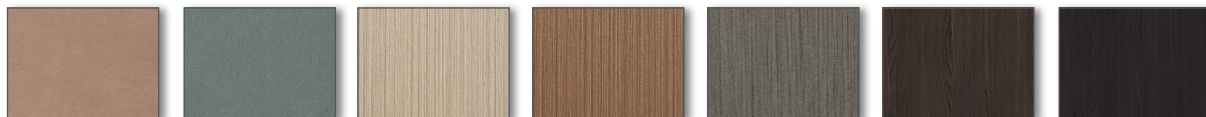

pietra fulvus opz. 8867
 pietra musk opz. 8403
 ottone chiaro opz. 7707
 rame brunito opz. 8868
 peltro opz. 9666
 elegant opz. 2409
 dark opz. 2410

Melaminico "Fascia 2"

Melamine "Band 2"

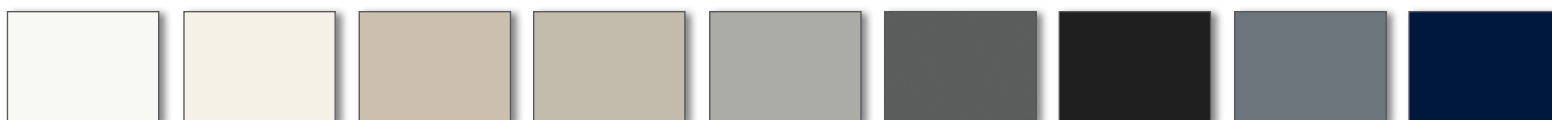

bianco opaco opz. 7405
 bianco neve opaco opz. 7407
 desert opaco opz. 8941
 polvere opaco opz. 9529
 beige colorado opaco opz. 7777
 antracite opaco opz. 9558
 nero opaco opz. 7895
 grigio minerale opaco opz. 9523
 blu cobalto opaco opz. 8383

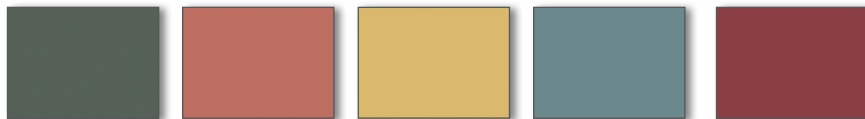

verde malga opaco opz. 8477
 rosso cameo opaco opz. 8160
 giallo cadmio opaco opz. 8255
 verde nilo opaco opz. 8475
 rosso velvet opaco opz. 8168



bianco lucido opz. 7406
 desert lucido opz. 8942
 polvere lucido opz. 9530
 antracite lucido opz. 9559
 nero lucido opz. 7896
 beige colorado lucido opz. 7778
 grigio minerale lucido opz. 9524
 rosso cameo lucido opz. 8164

Laccato UV UV lacquered



rovere naturale opz. 5442
 rovere grey opz. 5443
 rovere moscato opz. 5444
 rovere fumè opz. 5445
 rovere bianco opz. 5441
 rovere nero opz. 5446

Impiallacciato WOOD Veneered WOOD



telaio titanio
 telaio nero
 telaio silver dark
 telaio rame brunito

Telaio alluminio Aluminium frame



MADE IN ITALY: NORMA UNI 11674

La norma tutela l'acquirente garantendo l'origine italiana e le prestazioni di sicurezza e durata del prodotto, entrambe verificate periodicamente da uno dei più importanti laboratori di prova e certificazione per il legno-arredo in Italia: COSMOB.

MADE IN ITALY: STANDARD UNI 11674

This standard protects purchasers by guaranteeing the Italian origin, safety performance and useful life of products, both periodically verified by one of the leading testing and certification labs for wooden furnishings in Italy: COSMOB.



GREENGUARD

Il Programma di Certificazione GREENGUARD certifica che tutte le strutture dei prodotti a marchio LUBE e CREO sono conformi agli standard più rigorosi in termini di livelli di emissione di Composti Organici Volatili (COV) emessi da mobili, superfici e vernice oltre ad altre sostanze chimiche nocive negli ambienti interni.

GREENGUARD

The GREENGUARD certification programme certifies that all structures of LUBE and CREO products comply with the strictest standards in terms of emissions of volatile organic compounds (VOCs) from furniture, surfaces and coatings, as well as other harmful chemical substances in interior environments.



PANNELLO ECOLOGICO

Le strutture dei mobili LUBE e CREO sono realizzate con pannelli composti da legni riciclati al 100%, certificati dal Consorzio Pannello Ecologico e con materiali a basso impatto ambientale, certificati per la bassa emissione di formaldeide.

ECOLOGICAL PANELS

LUBE and CREO structures are created with panels made from 100% recycled wood, certified by the Eco-Panel Consortium, and from environmentally friendly materials, certified for low formaldehyde emissions.



GRUPPO LUBE ECOLOGIC

Il Gruppo LUBE utilizza per i componenti delle cucine (tutte le strutture, alcune ante e alcuni complementi), materiale conforme al regolamento EPA TSCA TITLE VI, uno dei più severi in merito alle normative di salvaguardia ambientale.

ECOLOGICAL PANELS

The LUBE Group uses for kitchen components (all carcasses, some doors and some accessories), material that complies with the EPA TSCA TITLE VI regulation, one of the strictest regarding environmental protection regulations.



SOSTENIBILITÀ AMBIENTALE

Lube Industries srl è dotata di Sistemi di Gestione per l'Efficienza Ambientale, per la Qualità e per la Salute e la Sicurezza sul Lavoro, in conformità alle norme: UNI EN ISO 14001, UNI EN ISO 9001 e UNI EN ISO 45001.

ENVIRONMENTAL SUSTAINABILITY

Lube Industries S.r.l. implements management systems for environmental efficiency, quality, and occupational health and safety, in conformity to the following standards: UNI EN ISO 14001, UNI EN ISO 9001 and UNI EN ISO 45001.



FSC®

La certificazione FSC® rappresenta il principale meccanismo di garanzia sull'origine del legno o della carta, con questa certificazione Lube Industries ha deciso di rendere noto il suo impegno nei confronti dell'ambiente e si schiera contro il disboscamento incontrollato e il taglio illegale di foreste.

FSC®

FSC® certification is the leading mechanism guaranteeing the origin of wood and paper. With this certification, Lube Industries has decided to demonstrate its commitment to the environment and stand against uncontrolled deforestation and illegal felling.

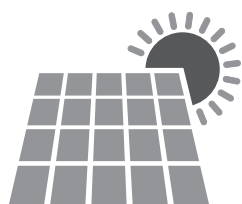

FOTOVOLTAICO

Energia pulita per prodotti di qualità. Un impianto fotovoltaico, installato nella sede aziendale, copre la superficie di 40.800 mq ed eroga una potenza di 6,2 MWp. L'energia prodotta quotidianamente dai pannelli solari, circa 6000 KWh, è in grado di soddisfare il fabbisogno dei processi produttivi aziendali.

PHOTOVOLTAICS

Clean energy for high-quality products. A photovoltaic plant, installed at the company headquarters, covers an area of 40,800 m2 and has a power output of 6.2 MWp. The energy generated daily by the solar panels, approximately 6,000 KWh, is enough to meet the company's production needs.

STRUTTURE

CARCASSES



bianco (opt.001)
schiena e ripiano bianco
(opt.001)
white (opt.001)
white back panel and shelf
(opt.001)



visone (opt.948M)
schiena e ripiano visone
(opt.948M)
mink (opt.948M)
mink back panel and shelf
(opt.948M)

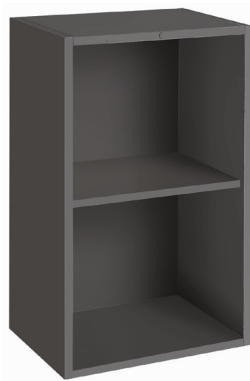

lavagna (opt.9620)
schiena e ripiano lavagna
(opt.9620)
slate grey (opt.9620)
slate grey back panel and shelf
(opt.9620)

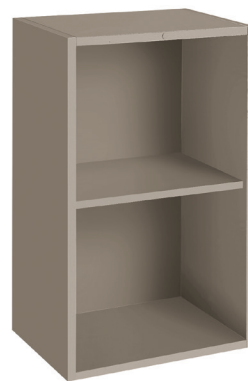

fango (opt.8860)
schiena e ripiano fango
(opt.8860)
mud (opt.8860)
mud back panel and shelf
(opt.8860)

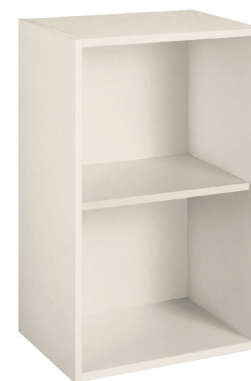

conchiglia (opt.8910)
schiena e ripiano conchiglia
(opt.8910)
shell (opt.8910)
shell back panel and shelf
(opt.8910)

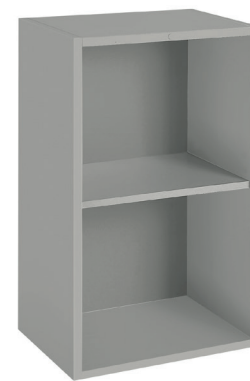

argilla (opt.9690)
schiena e ripiano argilla
(opt.9690)
clay (opt.9690)
clay back panel and shelf
(opt.9690)



ANTA
DOOR

STRUTTURA CONSIGLIATA
RECOMMENDED CARCASS



Per finiture ante e strutture consigliate vedi pagine 28/36
For doors finishes and recommended carcasses see pages 28/36

MENSOLE P. 31-61 COME STRUTTURE

D. 31-61 SHELVES AS CARCASSES

MENSOLE P. 31-61 COME ANTE

D. 31-61 SHELVES AS DOORS



bianco (opt.001)

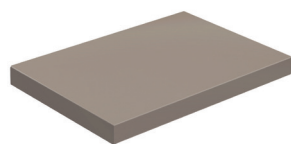

visone (opt.948M)



mensole in melaminico
melamine shelves

Per le finiture vedi pagine 28/31
For finishes see pages 28/31

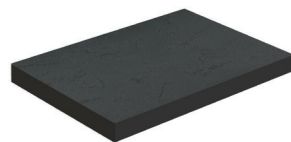

lavagna (opt.9620)

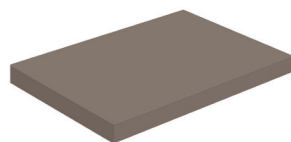

fango (opt.8860)

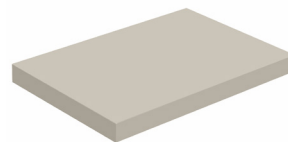

mensole laccate uv
uv lacquered shelves

Per le finiture vedi pagine 34/35
For finishes see pages 34/35

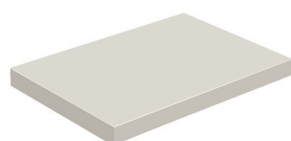

conchiglia (opt.8910)

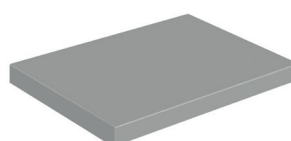

argilla (opt.9690)



mensole wood
wood shelves

Per le finiture vedi pagine 36
For finishes see pages 36

zoccoli in pvc pvc plinths



acciaio (opz.407)



di serie
standard

zoccoli in alluminio aluminium plinths



alluminio finitura titanio
ossidato (opz.414)

zoccoli in alluminio verniciati a polvere finitura opaca aluminum plinths height powder coated matt finish

COLORI FREDDI OPACHI SOFT SOFT MATT COLD COLOURS



bianco assoluto (opz.740S)

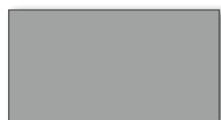

grigio traffico (opz.9511)



silver dark (opz.9507)



nero (opz.7892)



azzurro nube (opz.8379)



azzurro ottanio (opz.8385)



grigio bromo (opz.9533)

COLORI CALDI OPACHI SOFT SOFT MATT HOT COLOURS

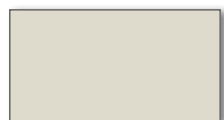

lino (opz.9513)

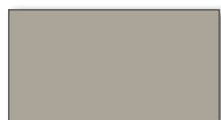

grigio kenya (opz.9501)

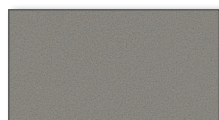

grigio selce (opz.SE)

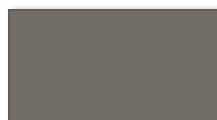

grigio piombo (opz.9537)

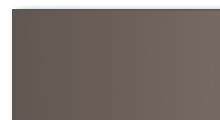

terra d'ombra (opz.955T)



ottone (opz.7761)



umber (opz.955U)



cuoio (opz.8887)



ghisa (opz.9509)



fumo (opz.9531)



giallo digione (opz.8257)

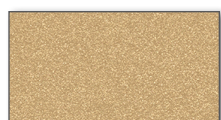

oro (opz.AU)

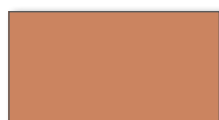

cotto (opz.8887)



rame (opz.8167)



rame brunito (opz.8168)



rosso persia (opz.8165)

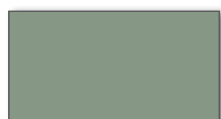

verde celadon (opz.8485)



rosso velvet (opz.8169)

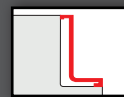

Neck

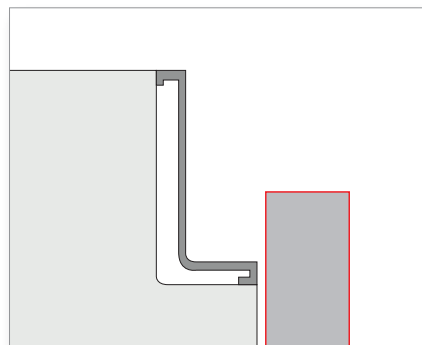

ANTA SQUADRATA SENZA PROFILO

SQUARED DOOR WITHOUT
PROFILE

FINITURE PROFILI E GOLE SPAZZOLATI FINGER RAILS AND PROFILES BRUSHED FINISHES



titanio ossidato (opz.414)

FINITURE PROFILI E GOLE VERNICIATI A POLVERE OPACHI MATT FINGER RAILS AND PROFILES POWDER COATED FINISHES

COLORI FREDDI OPACHI SOFT SOFT MATT COLD COLOURS



bianco assoluto (opz.740S)



grigio traffico (opz.9511)

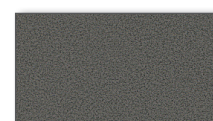

silver dark (opz.9507)



nero (opz.7892)



azzurro nube (opz.8379)



azzurro ottanio (opz.8385)



grigio bromo (opz.9533)

COLORI CALDI OPACHI SOFT SOFT MATT HOT COLOURS



lino (opz.9513)



grigio kenya (opz.9501)

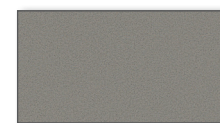

grigio selce (opz.SE)

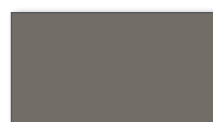

grigio piombo (opz.9537)



terra d'ombra (opz.955T)



umber (opz.955U)



ottone (opz.7761)



cuoio (opz.8897)



ghisa (opz.9509)



fumo (opz.9531)



giallo digione (opz.8257)

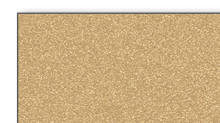

oro (opz.AU)



cotto (opz.8887)



rame (opz.8167)

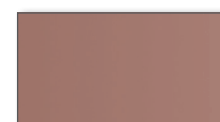

rame brunito (opz.8168)

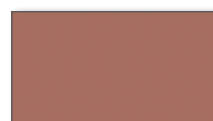

rosso persia (opz.8165)

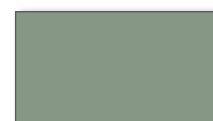

verde celadon (opz.8485)



rosso velvet (opz.8169)

Bridge

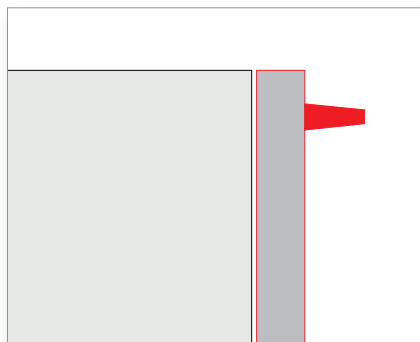

**ANTA CON MANIGLIA
FRONTALE**
DOOR WITH FRONT HANDLE

Head

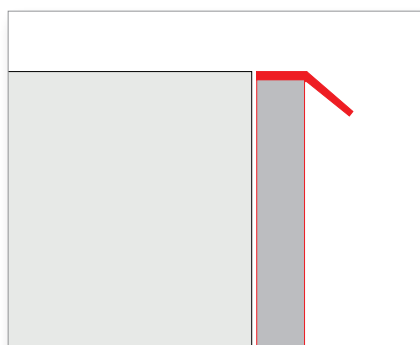





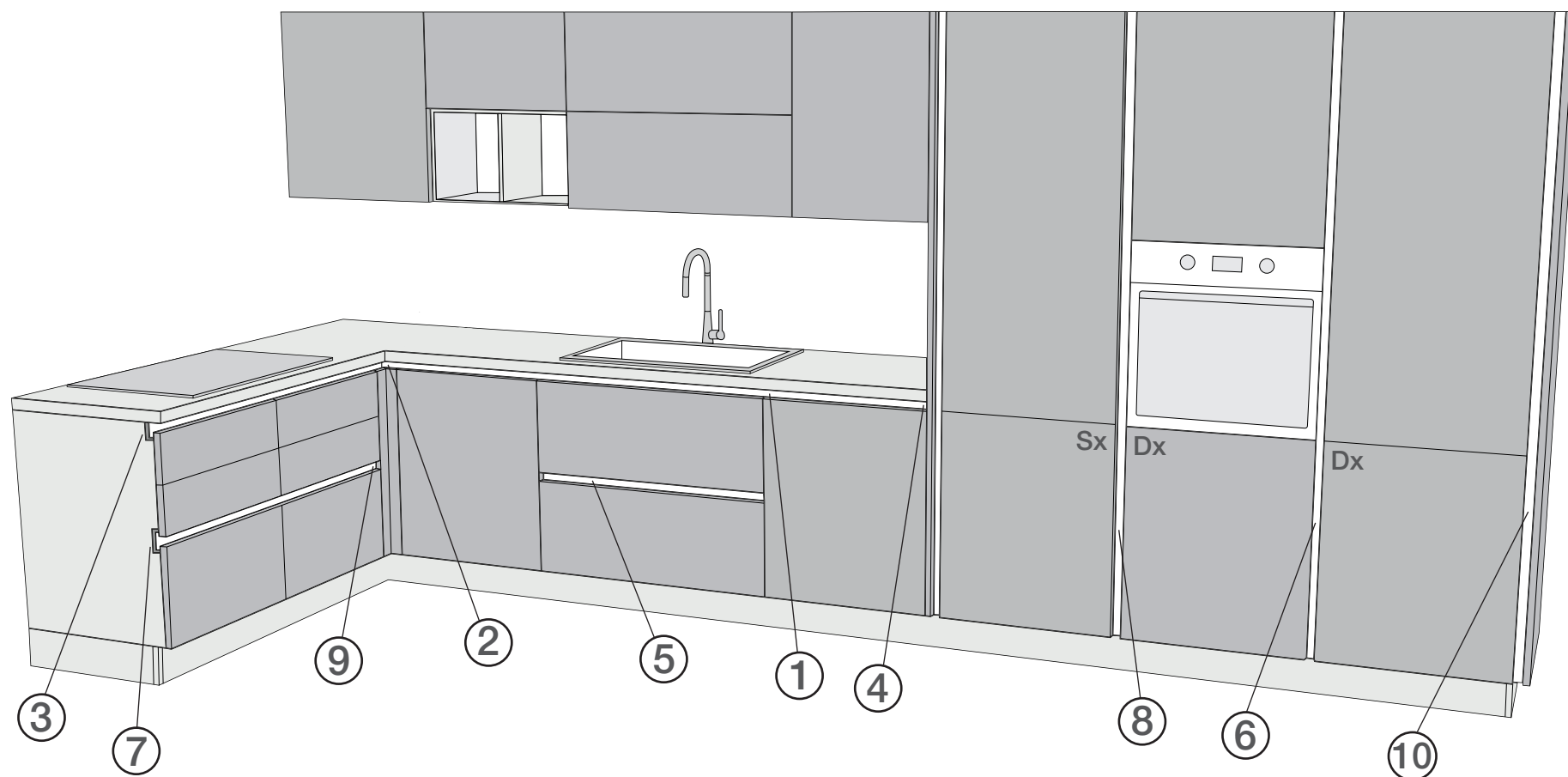
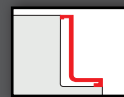

**ANTA CON MANIGLIA
APPLICATA IN TESTA**
DOOR WITH TOP-MOUNTED HANDLE

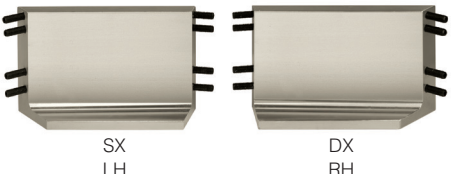
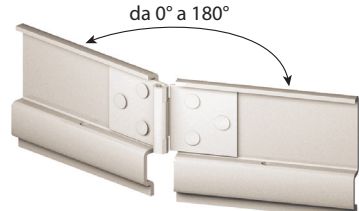



	COD.			COD.
<p>1</p> <p>Gola sottotop tipo "A" Type "A" undermount finger rail</p> <p style="text-align: right;">al ml per lm</p>	G950010		<p>2</p> <p>Angolo interno a 90° per gola tipo "A"</p> <p>90° interior corner for "A" type finger rail</p> <p style="text-align: right;">cadauno each</p>	G950050
<p>3</p> <p>Terminale aperto dx o sx per gola tipo "A" da utilizzare a fine composizione in presenza di fianco struttura non rifinito. RH or LH open end for type "A" finger rail to be placed at the end of the composition in presence of unfinished structure side.</p> <p style="text-align: right;">terminale DX RH end terminale SX LH end</p>	G950021 G950022		<p>4</p> <p>Terminale chiuso dx o sx per gola tipo "A" da utilizzare solo tra basi e colonne o a fine composizione in presenza di fianco struttura rifinito come anta senza scassi per gola. RH or LH closure for type "A" finger rail to be placed only between base units and column or at the end of the composition in presence of structure side finished as a door without recess for finger rail.</p> <p style="text-align: right;">terminale DX RH end terminale SX LH end</p>	G950031 G950032

	COD.			COD.	
<p>Coppia angolari per kit raccordo base angolo 110x110 Obbligatori Couple corner piece for fitting kit corner base unit 110x110 Obbligatori</p>  <p>SX LH DX RH</p> <p>in alluminio aluminium angolare DX RH corner piece angolare SX LH corner piece</p>				<p>2</p> <p>Angolare con snodo per unione fuori squadra per gola tipo "A" Corner piece with joint for out-of-plumb joining for type "A" finger rail</p>  <p>da 0° a 180°</p>	
	G950058				
	G950059			G950060	
<p>5</p> <p>Gola intermedia tipo "B" Type "B" intermediate finger rail</p>  <p>al ml per lm</p>				<p>6</p> <p>Mezza gola verticale tipo "C" (completa di distanziale) Type "C" half vertical finger rail (complete with spacer)</p>  <p>sezione mezza gola tipo "C" cross section of type "C" finger rail</p> <p>Piedi H 13 H 96 H 132 H 204 H 228</p> <p>Piedi H 6 H 108 H 144 H 216</p>	
	G950110			G950310	
				G950330	
				G950350	
				G950370	
				G950320	
				G950340	
				G950360	
<p>7</p> <p>Terminale aperto dx o sx per gola tipo "B" da utilizzare a fine composizione in presenza di fianco struttura non rifinito. RH or LH open end for type "B" finger rail to be placed at the end of the composition in presence of unfinished structure side.</p>  <p>terminale DX RH end terminale SX LH end</p>				<p>8</p> <p>Gola verticale intermedia tipo "D" (completa di distanziale) Type "D" intermediate vertical finger rail (complete with spacer)</p>  <p>sezione gola tipo "D" cross section of type "D" finger rail</p> <p>Piedi H 13 H 96 H 132 H 204 H 228</p> <p>Piedi H 6 H 108 H 144 H 216</p>	
	G950121			G950410	
	G950122			G950430	
				G950450	
				G950470	
				G950420	
				G950440	
				G950460	
<p>9</p> <p>Terminale chiuso dx o sx per gola tipo "B" da utilizzare solo tra cassettiere e lavastoviglie/colonne o a fine composizione in presenza di fianco struttura rifinito come anta senza scassi per gola. RH or LH closure for type "B" finger rail to be placed only between drawer units and dishwasher/columns or at the end of the composition in presence of structure side finished as a door without recess for finger rail.</p>  <p>terminale DX RH end terminale SX LH end</p>				<p>10</p> <p>Gola verticale laterale tipo "E" (completa di distanziale) Type "E" lateral vertical finger rail (complete with spacer)</p>  <p>sezione gola tipo "E" cross section of type "E" finger rail</p> <p>Piedi H 13 H 96 H 132 H 204 H 228</p> <p>Piedi H 6 H 108 H 144 H 216</p>	
	G950131			G950510	
	G950132			G950530	
				G950550	
				G950570	
				G950520	
				G950540	
				G950560	



VISTA FRONTALE E LATERALE ZOCCOLO H 13 PER BASI H 88

FRONT AND SIDE VIEW PLINTH H 13 FOR BASE UNITS H 88

PROSPETTO LATERALE

Fianco struttura come anta
senza scasso per gola

SIDE VIEW

Structural side as door without
recess for finger rail

PROSPETTO LATERALE

Fianco struttura con scassi per gola

SIDE VIEW

Structural side with recess for finger rail

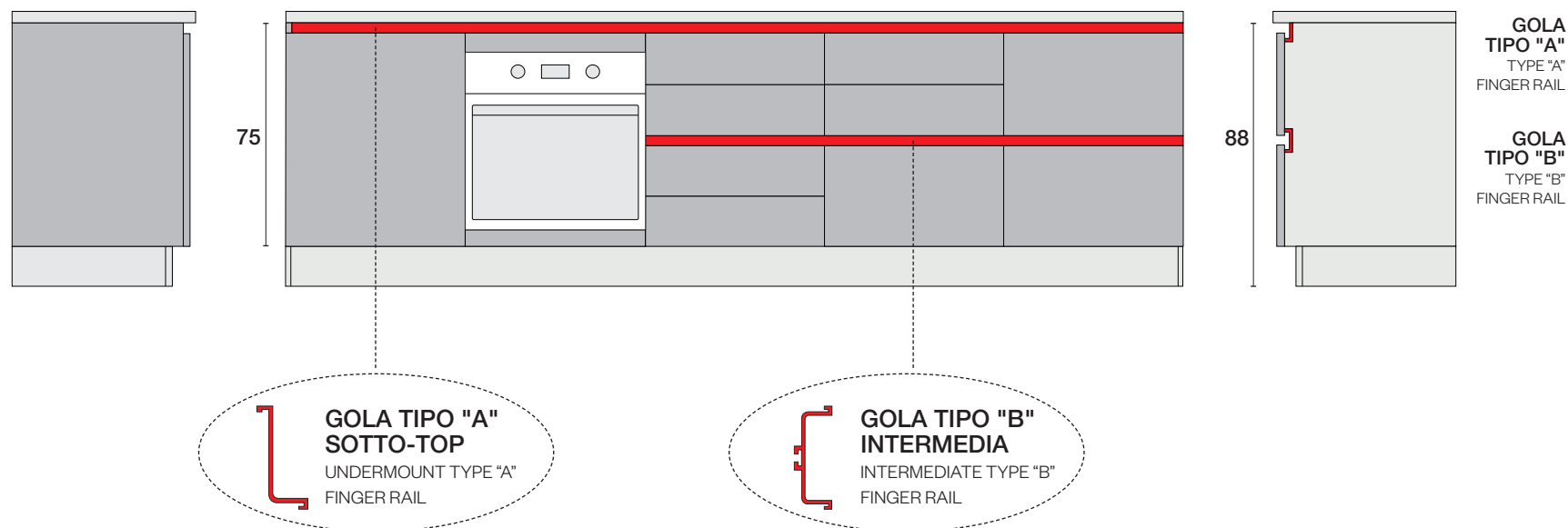

VISTA FRONTALE E LATERALE ZOCCOLO H 6 PER BASI H 90

FRONT AND SIDE VIEW PLINTH H 6 FOR BASE UNITS H 90

PROSPETTO LATERALE

Fianco struttura come anta
senza scasso per gola

SIDE VIEW

Structural side as door without
recess for finger rail

PROSPETTO LATERALE

Fianco struttura con scassi per gola

SIDE VIEW

Structural side with recess for finger rail

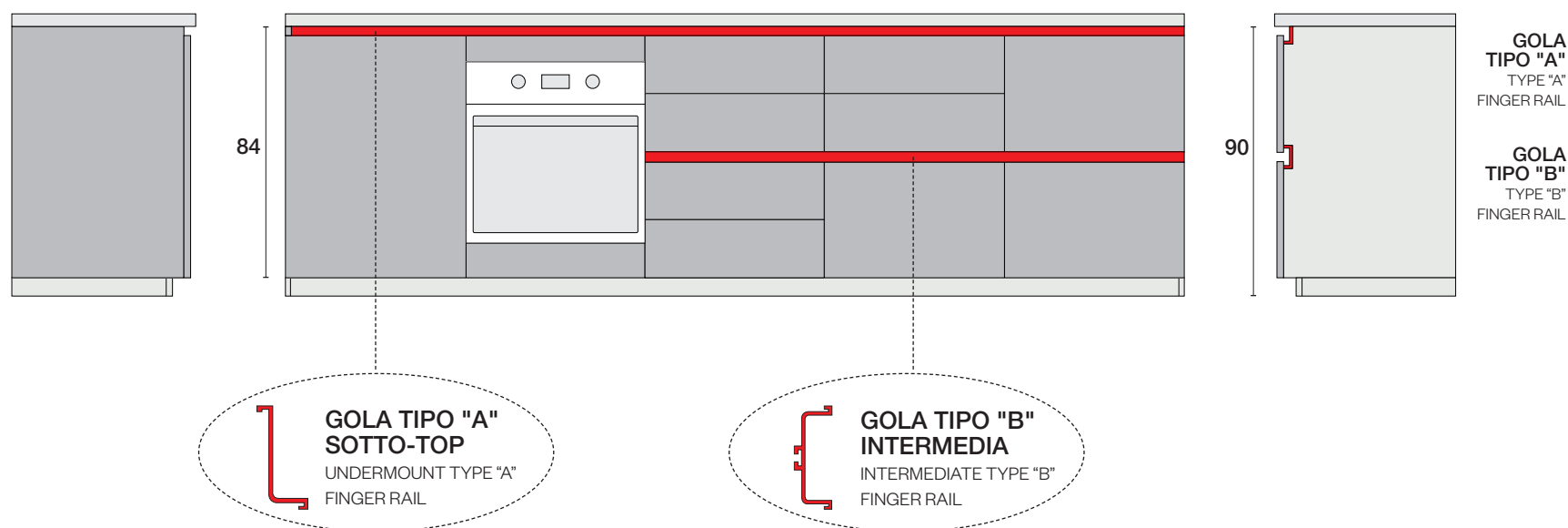



VISTA FRONTALE ZOCCOLO H 13

FRONT VIEW PLINTH H 13

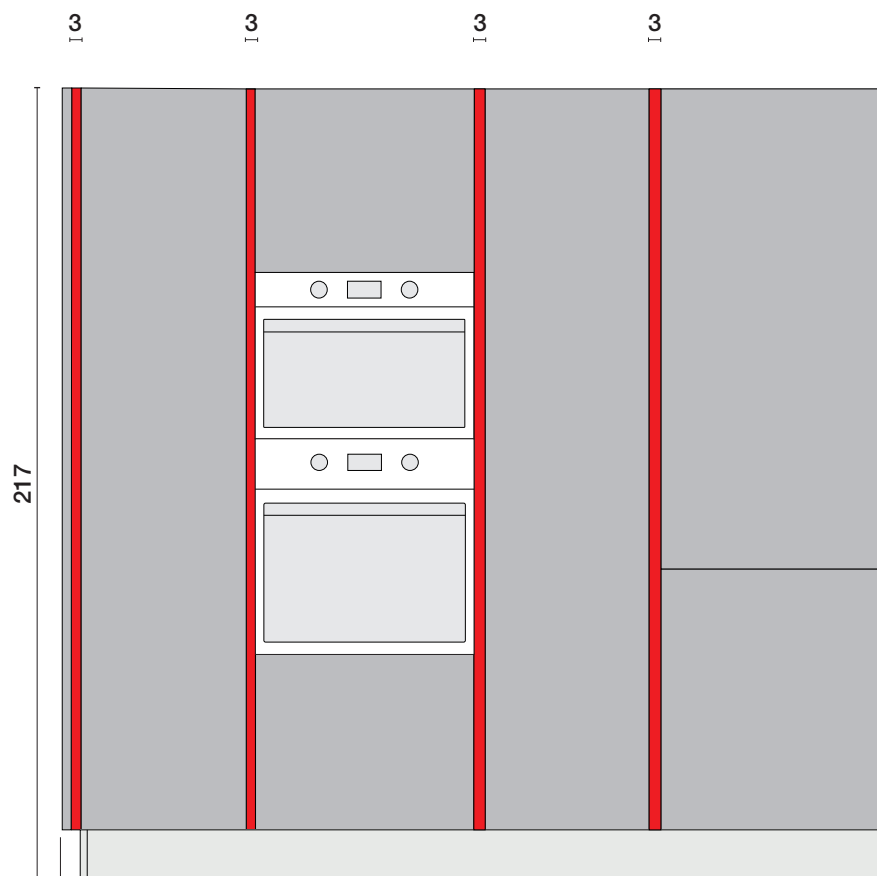

FIANCO RIPORTATO
COME ANTA SP. 22 MM
ADDITIONAL SIDE PANEL
AS DOOR TH. 22 MM

VISTA FRONTALE ZOCCOLO H 6

FRONT VIEW PLINTH H 6

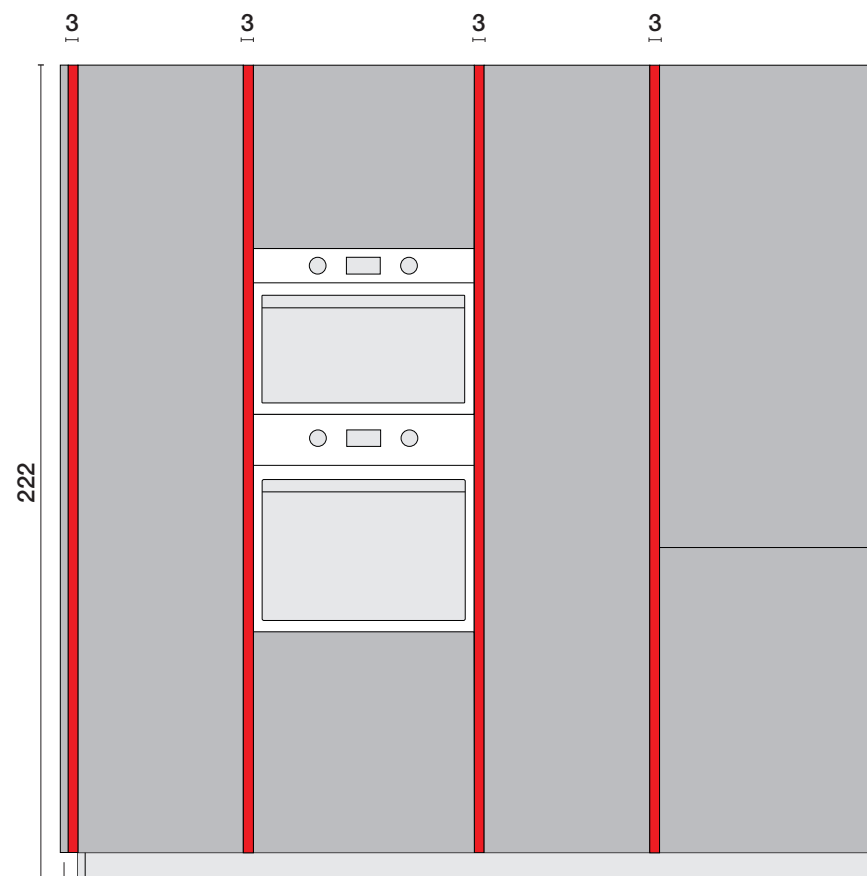

FIANCO RIPORTATO
COME ANTA SP. 22 MM
ADDITIONAL SIDE PANEL
AS DOOR TH. 22 MM

VISTA DALL'ALTO

TOP VIEW

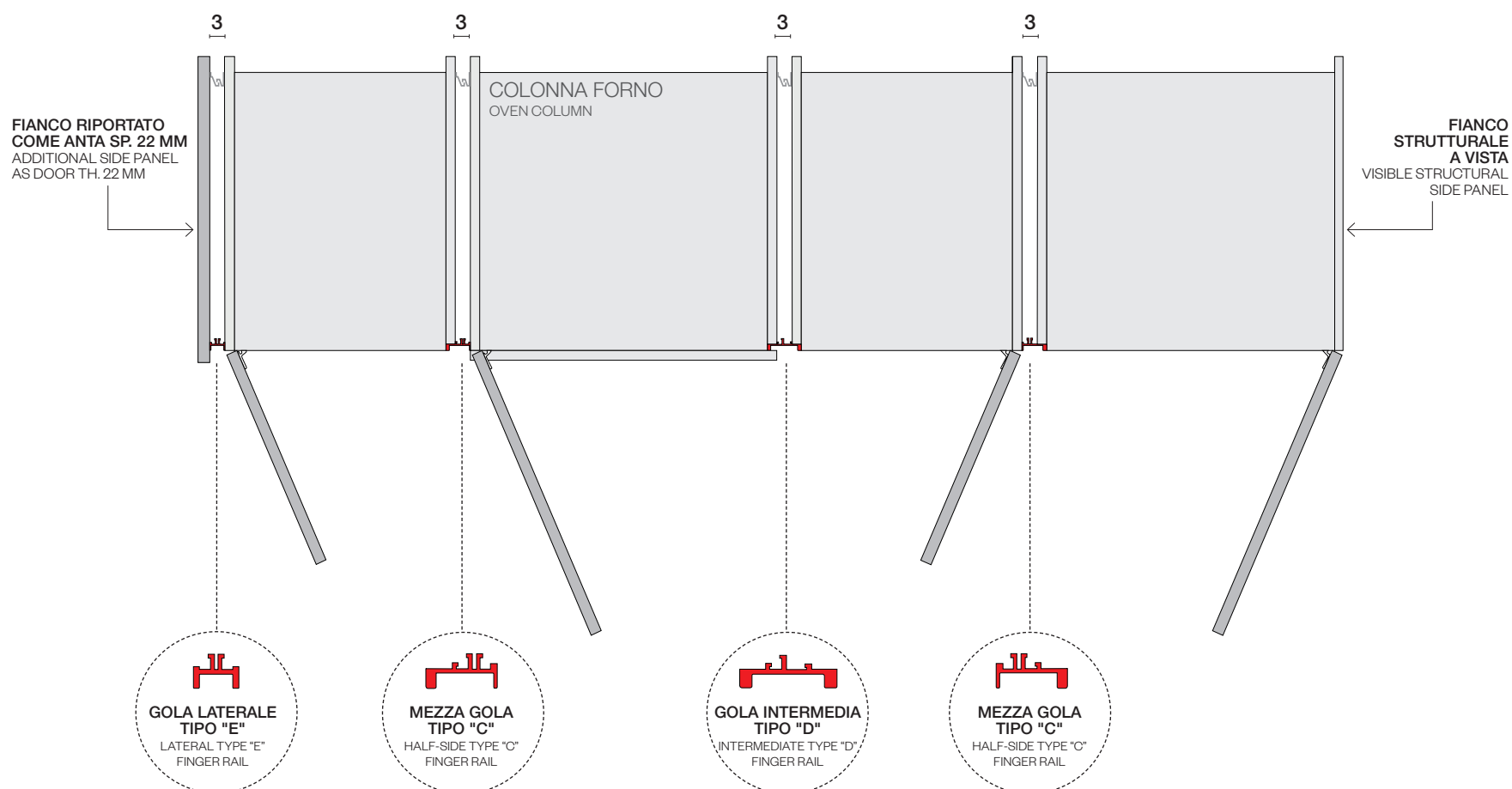



DI SERIE STANDARD



Maniglia F547 finitura nichel satinato
anta L 15 → passo 64 mm
anta da L 30 a L 90 → passo 160 mm

Handle F547 with satin nickel finish
door W 15 → centre-to-centre distance 64 mm
door from W 30 to W 90 → centre-to-centre distance 160 mm



Maniglia K56 finitura satinato opaco
anta L 15 → passo 64 mm
anta da L 30 a L 60 → passo 160 mm
anta da L 75 a L 90 → passo 320 mm

Handle K56 matt satin finish
door W 15 → centre-to-centre distance 64 mm
door from W 30 to W 60 → centre-to-centre distance 160 mm
door from W 75 to W 90 → centre-to-centre distance 320 mm

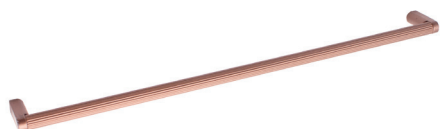

Maniglia 351R finitura rame brunito
anta L 15 → passo 96 mm
anta L 30 a L 45 → passo 160 mm
anta da L 60 a L 120 → passo 320 mm

Handle 351R brushed copper finish
door W 15 → centre-to-centre distance 96 mm
door W 30 to W 45 → centre-to-centre distance 160 mm
door from W 60 to W 120 → centre-to-centre distance 320 mm



Maniglia 351T finitura titanio
anta L 15 → passo 96 mm
anta L 30 a L 45 → passo 160 mm
anta da L 60 a L 120 → passo 320 mm

Handle 351T titanium finish
door W 15 → centre-to-centre distance 96 mm
door W 30 to W 45 → centre-to-centre distance 160 mm
door from W 60 to W 120 → centre-to-centre distance 320 mm

A RICHIESTA ON REQUEST



Maniglia K50 finitura cromo
anta da L 30 a L 45 → passo 160 mm
anta da L 60 a L 90 → passo 320 mm

Handle K50 chrome finish
door from W 30 to W 45 → centre-to-centre distance 160 mm
door from W 60 to W 90 → centre-to-centre distance 320 mm



Maniglia K57 finitura verniciato brunito
anta L 15 → passo 64 mm
anta da L 30 a L 60 → passo 160 mm
anta da L 75 a L 90 → passo 320 mm

Handle K57 with burnished painted finish
door W 15 → centre-to-centre distance 64 mm
door from W 30 to W 60 → centre-to-centre distance 160 mm
door from W 75 to W 90 → centre-to-centre distance 320 mm



Maniglia 351S finitura silver dark
anta L 15 → passo 96 mm
anta L 30 a L 45 → passo 160 mm
anta da L 60 a L 120 → passo 320 mm

Handle 351S silver dark finish
door W 15 → centre-to-centre distance 96 mm
door W 30 to W 45 → centre-to-centre distance 160 mm
door from W 60 to W 120 → centre-to-centre distance 320 mm



Maniglia 351B finitura dark brown
anta L 15 → passo 96 mm
anta L 30 a L 45 → passo 160 mm
anta da L 60 a L 120 → passo 320 mm

Handle 351B brown dark finish
door W 15 → centre-to-centre distance 96 mm
door W 30 to W 45 → centre-to-centre distance 160 mm
door from W 60 to W 120 → centre-to-centre distance 320 mm



Pomo 244P finitura cromo
solo per anta L 15 in abbinamento
alla maniglia K50

Knob 244P chrome finish
only for door W 15 in combination
to the handle K50



Maniglia K58 finitura nero opaco
anta L 15 → passo 64 mm
anta da L 30 a L 60 → passo 160 mm
anta da L 75 a L 90 → passo 320 mm

Handle K58 matt black finish
door W 15 → centre-to-centre distance 64 mm
door from W 30 to W 60 → centre-to-centre distance 160 mm
door from W 75 to W 90 → centre-to-centre distance 320 mm



Maniglia 352G finitura oro
anta L 15 → pomo
anta L 30 a L 45 → passo 160 mm
anta da L 60 a L 120 → passo 320 mm

Handle 352G gold finish
door W 15 → knob
door W 30 to W 45 → centre-to-centre distance 160 mm
door from W 60 to W 120 → centre-to-centre distance 320 mm

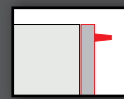

A RICHIESTA ON REQUEST

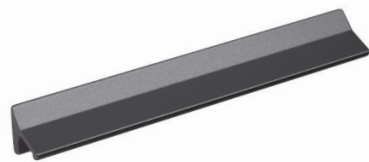

Maniglia 592S finitura silver dark
anta L 15 → passo 64 mm
anta L 30 a L 45 → passo 160 mm
anta da L 60 a L 120 → passo 320 mm

Handle 592S dark silver finish
door W 15 → centre-to-centre distance 64 mm
door W 30 to W 45 → centre-to-centre distance 160 mm
door from W 60 to W 120 → centre-to-centre distance 320 mm

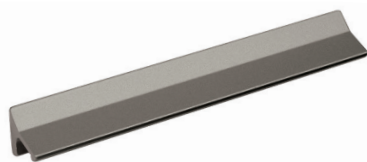

Maniglia 592B finitura bronzo brunito
anta L 15 → passo 64 mm
anta L 30 a L 45 → passo 160 mm
anta da L 60 a L 120 → passo 320 mm

Handle 592B burnished bronze finish
door W 15 → centre-to-centre distance 64 mm
door W 30 to W 45 → centre-to-centre distance 160 mm
door from W 60 to W 120 → centre-to-centre distance 320 mm

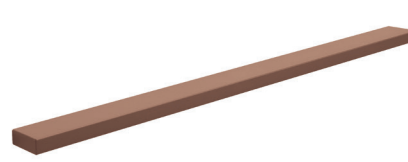

Maniglia 59RA finitura anodizzato rame anticato
anta L 15 → passo 32 mm
anta L 30 a L 45 → passo 160 mm
anta da L 60 a L 120 → passo 448 mm

Handle 59RA oxidized antiqued copper finish
door W 15 → centre-to-centre distance 32 mm
door W 30 to W 45 → centre-to-centre distance 160 mm
door from W 60 to W 120 → centre-to-centre distance 448 mm



Maniglia K92 finitura grigio selce
anta da L 15 a L 30 → passo 64 mm
anta da L 40 a L 65 → passo 160 mm
anta da L 75 a L 120 → passo 320 mm

Handle K92 flint grey finish
door from W 15 to W 30 → centre-to-centre distance 64 mm
door from W 40 to W 65 → centre-to-centre distance 160 mm
door from W 75 to W 120 → centre-to-centre distance 320 mm



Maniglia K93 finitura ghisa
anta da L 15 a L 30 → passo 64 mm
anta da L 40 a L 65 → passo 160 mm
anta da L 75 a L 120 → passo 320 mm

Handle K93 caston iron finish
door from W 15 to W 30 → centre-to-centre distance 64 mm
door from W 40 to W 65 → centre-to-centre distance 160 mm
door from W 75 to W 120 → centre-to-centre distance 320 mm



Maniglia K94 finitura silver dark
anta da L 15 a L 30 → pomo
anta da L 40 a L 65 → passo 160 mm
anta da L 75 a L 120 → passo 320 mm

Handle K94 dark silver finish
door from W 15 to W 30 → knob
door from W 40 to W 65 → centre-to-centre distance 160 mm
door from W 75 to W 120 → centre-to-centre distance 320 mm



Maniglia K85 finitura cromo satinato
anta da L 15 a L 30 → passo 96 mm
anta da L 40 a L 65 → passo 160 mm
anta da L 75 a L 120 → passo 320 mm

Handle K85 satin chrome finish
door from W 15 to W 30 → centre-to-centre distance 96 mm
door from W 40 to W 65 → centre-to-centre distance 160 mm
door from W 75 to W 120 → centre-to-centre distance 320 mm



Maniglia K87 finitura nichel lux
anta da L 15 a L 30 → passo 96 mm
anta da L 40 a L 65 → passo 160 mm
anta da L 75 a L 120 → passo 320 mm

Handle K87 lux nickel finish
door from W 15 to W 30 → centre-to-centre distance 96 mm
door from W 40 to W 65 → centre-to-centre distance 160 mm
door from W 75 to W 120 → centre-to-centre distance 320 mm



Maniglia K90 finitura bronzo
anta da L 15 a L 30 → passo 64 mm
anta da L 40 a L 120 → passo 160 mm

Handle K90 bronze finish
door from W 15 to W 30 → centre-to-centre distance 64 mm
door from W 40 to W 120 → centre-to-centre distance 160 mm

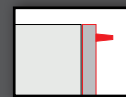

MANIGLIA VERTICALE VERTICAL HANDLE



Maniglia M30NV finitura nero opaco
passo in funzione dell'anta, vedi disegno tecnico
Handle M30NV matt black finish
centre-to-centre distance varies according to the door, see technical drawing

 La maniglia verticale non è disponibile per tutti gli elementi. Non inseribile su pensili, basi ed elementi fuori misura
The vertical handle is not compatible with all the elements. Is not possible to insert it on the wall units, base units and oversized elements

MANIGLIA HANDLE	L. 39,7	passo 383 mm
MANIGLIA HANDLE	L. 51,7	passo 503 mm
MANIGLIA HANDLE	L. 63,7	passo 623 mm
MANIGLIA HANDLE	L. 75,7	passo 743 mm
MANIGLIA HANDLE	L. 123,7	passo 623/600 mm
MANIGLIA HANDLE	L. 135,7	passo 743/600 mm
MANIGLIA HANDLE	L. 195,7	passo 623/697/623 mm
MANIGLIA HANDLE	L. 207,7	passo 623/697/743 mm

DISEGNO TECNICO MANIGLIA HANDLE TECHNICAL DRAWING

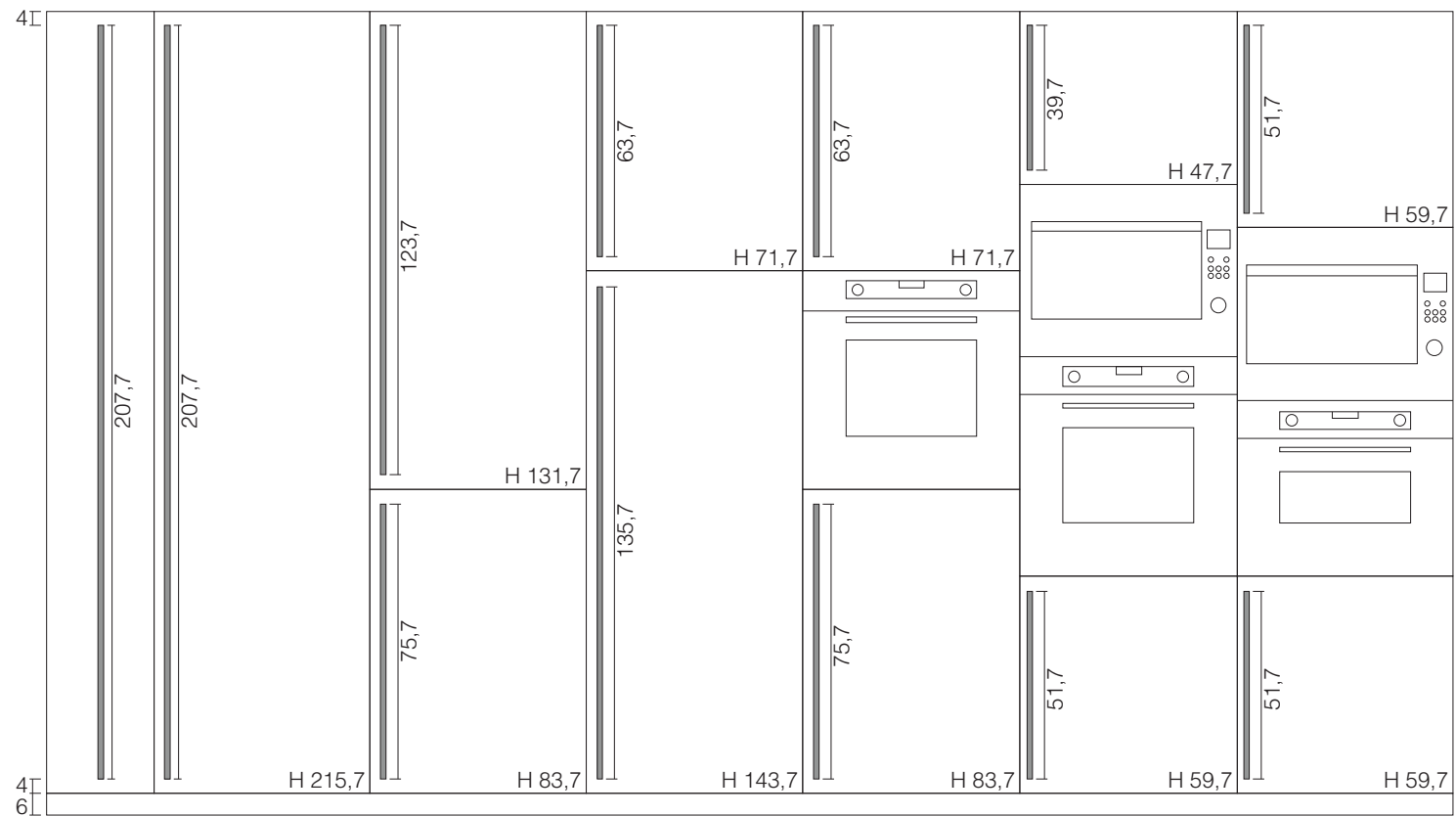
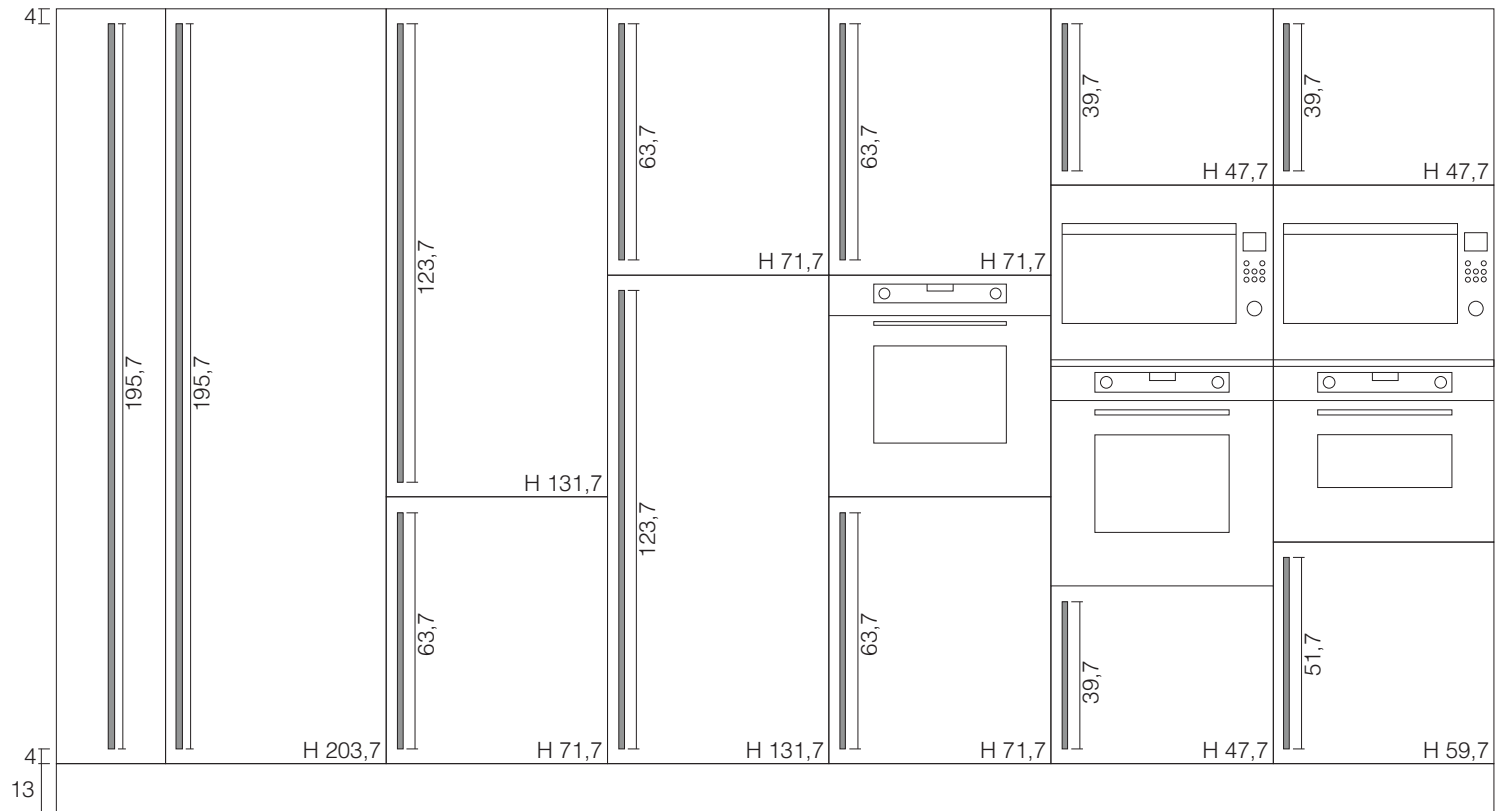

 La maniglia verticale è disponibile anche per colonne con anta fino a terra, mantenendo lo stesso allineamento dall'alto riportato nei disegni tecnici.
 The vertical handle is also available for columns with door down the ground while maintaining the same alignment from above shown in the technical drawings.

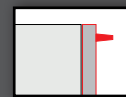

MANIGLIA VERTICALE VERTICAL HANDLE



MANIGLIA HANDLE	L. 41,7	passo 383 mm
MANIGLIA HANDLE	L. 53,7	passo 503 mm
MANIGLIA HANDLE	L. 65,7	passo 623 mm
MANIGLIA HANDLE	L. 77,7	passo 743 mm
MANIGLIA HANDLE	L. 125,7	passo 623/600 mm
MANIGLIA HANDLE	L. 137,7	passo 743/600 mm
MANIGLIA HANDLE	L. 197,7	passo 623/697/623 mm
MANIGLIA HANDLE	L. 209,7	passo 623/697/743 mm

Maniglia M31KV finitura satinato spazzolato
passo in funzione dell'anta, vedi disegno tecnico
Handle M31KV satin brushed finish
centre-to-centre distance varies according to the door, see technical drawing



MANIGLIA HANDLE	L. 41,7	passo 383 mm
MANIGLIA HANDLE	L. 53,7	passo 503 mm
MANIGLIA HANDLE	L. 65,7	passo 623 mm
MANIGLIA HANDLE	L. 77,7	passo 743 mm
MANIGLIA HANDLE	L. 125,7	passo 623/600 mm
MANIGLIA HANDLE	L. 137,7	passo 743/600 mm
MANIGLIA HANDLE	L. 197,7	passo 623/697/623 mm
MANIGLIA HANDLE	L. 209,7	passo 623/697/743 mm

Maniglia M32TV finitura titanio
passo in funzione dell'anta, vedi disegno tecnico
Handle M32TV titanium finish
centre-to-centre distance varies according to the door, see technical drawing

 La maniglia verticale non è disponibile per tutti gli elementi. Non inseribile su pensili, basi ed elementi fuori misura.
The vertical handle is not compatible with all the elements. Is not possible to insert it on the wall units, base units and oversized elements

DISEGNO TECNICO MANIGLIE HANDLES TECHNICAL DRAWING

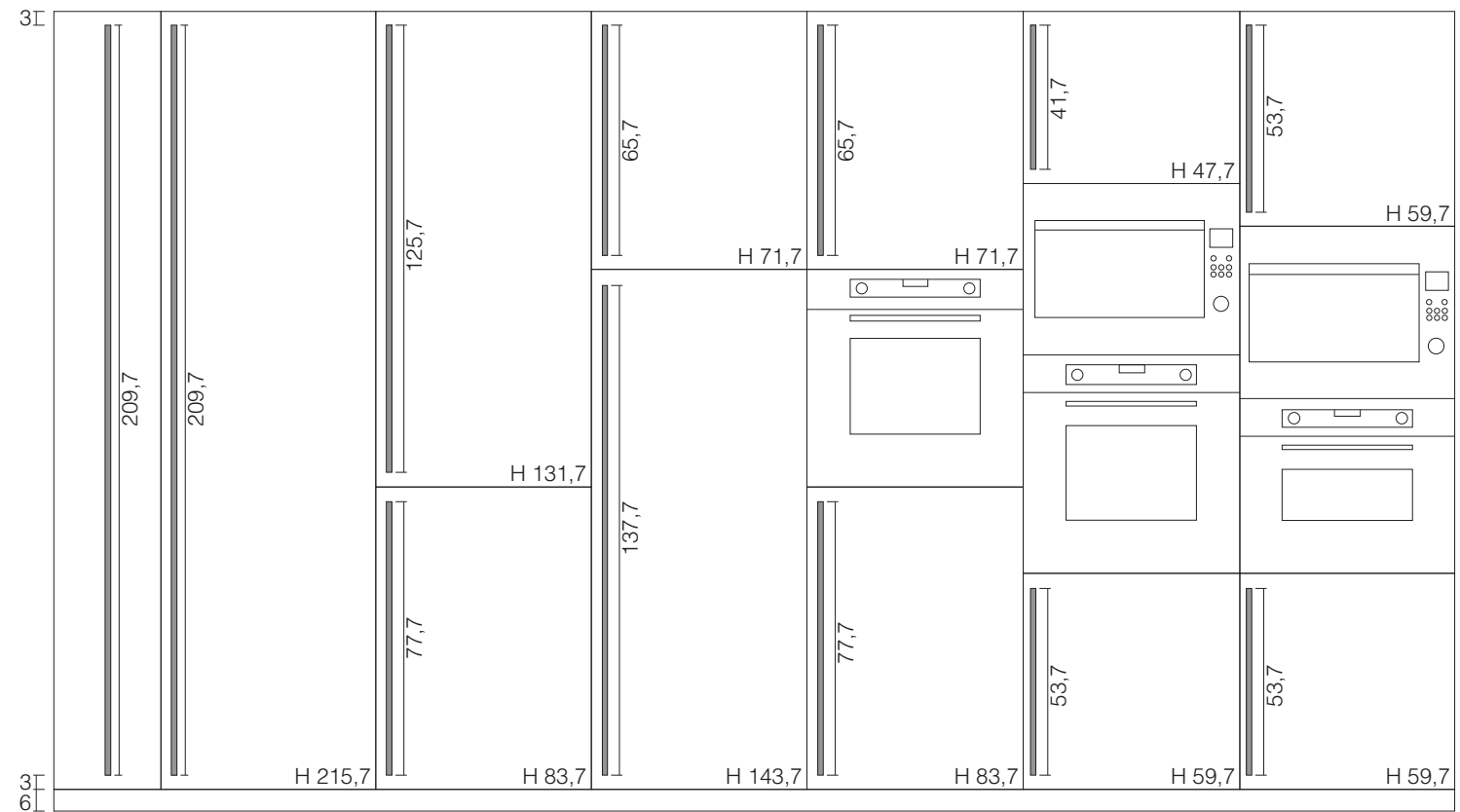
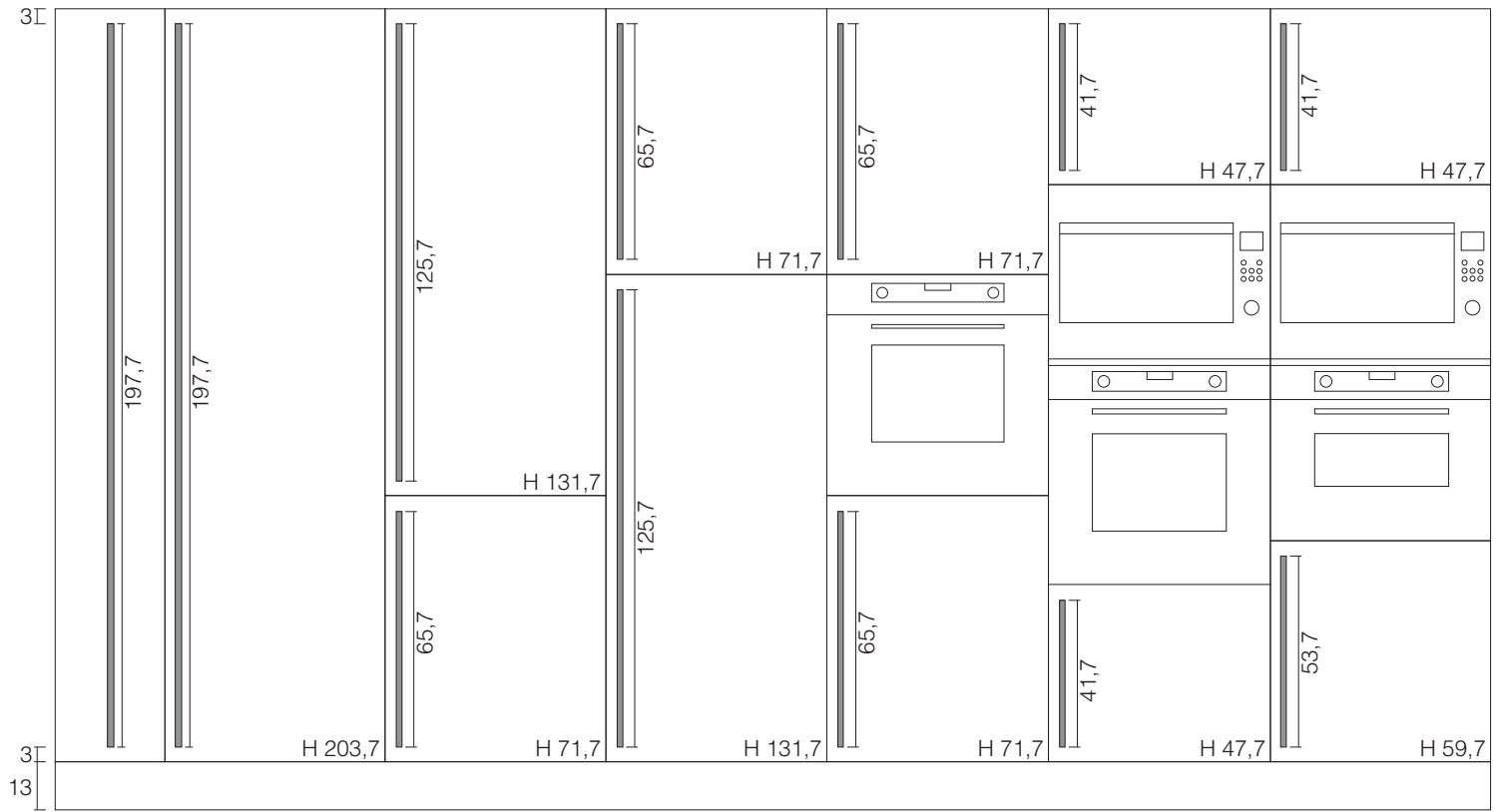

 La maniglia verticale è disponibile anche per colonne con anta fino a terra, mantenendo lo stesso allineamento dall'alto riportato nei disegni tecnici.
The vertical handle is also available for columns with door down the ground while maintaining the same alignment from above shown in the technical drawings.



Maniglia M30NO finitura nero opaco
passo in funzione dell'anta
vedi disegno tecnico

Handle M30NO matt black finish
centre-to-centre distance varies according
to the door size see technical drawing

DISEGNO TECNICO MANIGLIA HANDLE TECHNICAL DRAWING

Angolo pensile a libro
Book hanging corner

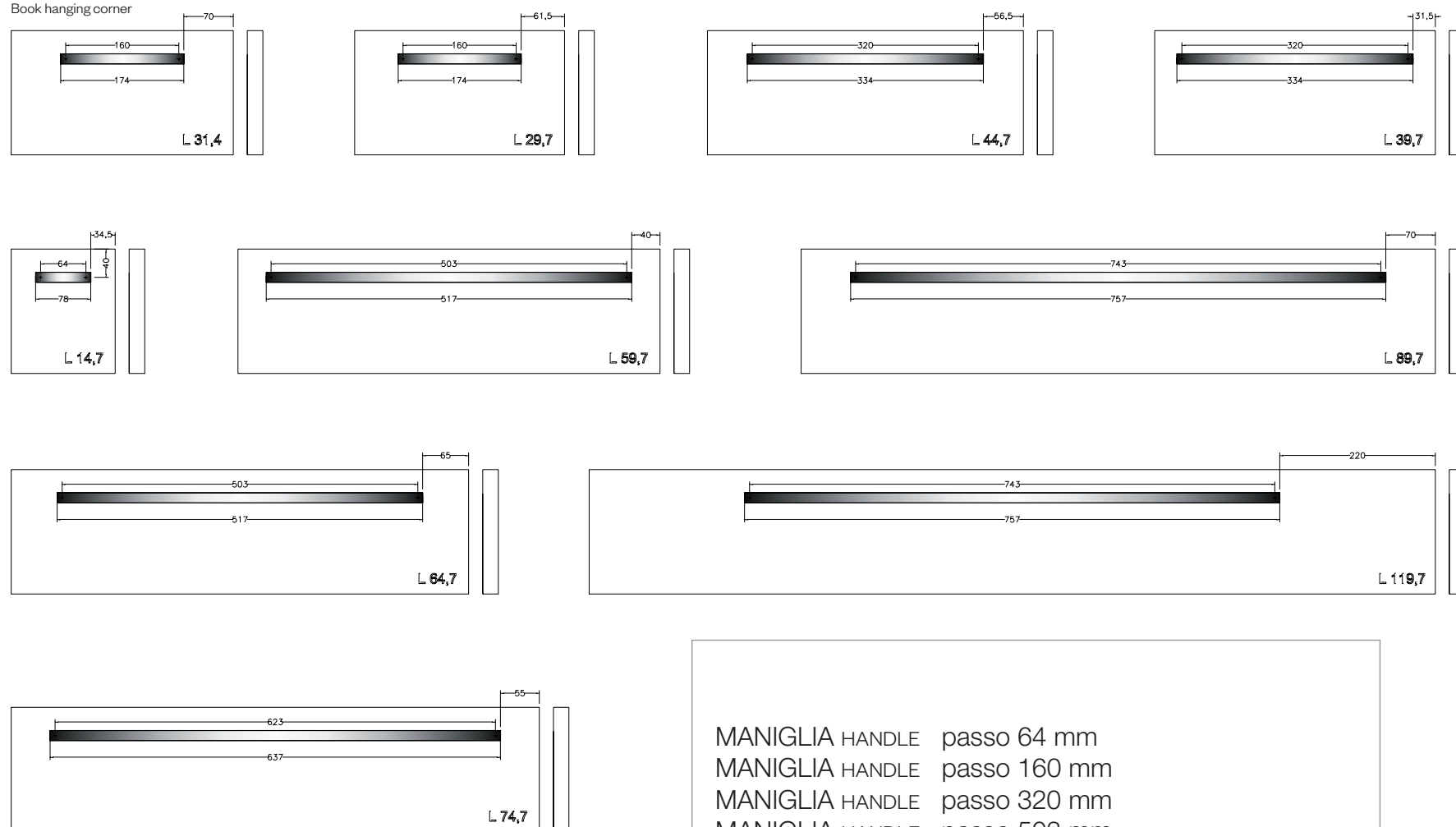

- MANIGLIA HANDLE passo 64 mm
- MANIGLIA HANDLE passo 160 mm
- MANIGLIA HANDLE passo 320 mm
- MANIGLIA HANDLE passo 503 mm
- MANIGLIA HANDLE passo 623 mm
- MANIGLIA HANDLE passo 743 mm



Maniglia M31KO finitura satinato spazzolato
passo in funzione dell'anta
vedi disegno tecnico

Handle M31KO satin brushed finish
centre-to-centre distance varies according
to the door size see technical drawing



Maniglia M32TO finitura titanio
passo in funzione dell'anta
vedi disegno tecnico

Handle M32TO titanium finish
centre-to-centre distance varies according
to the door size see technical drawing

DISEGNO TECNICO MANIGLIA HANDLE TECHNICAL DRAWING

Angolo pensile a libro
Book hanging corner

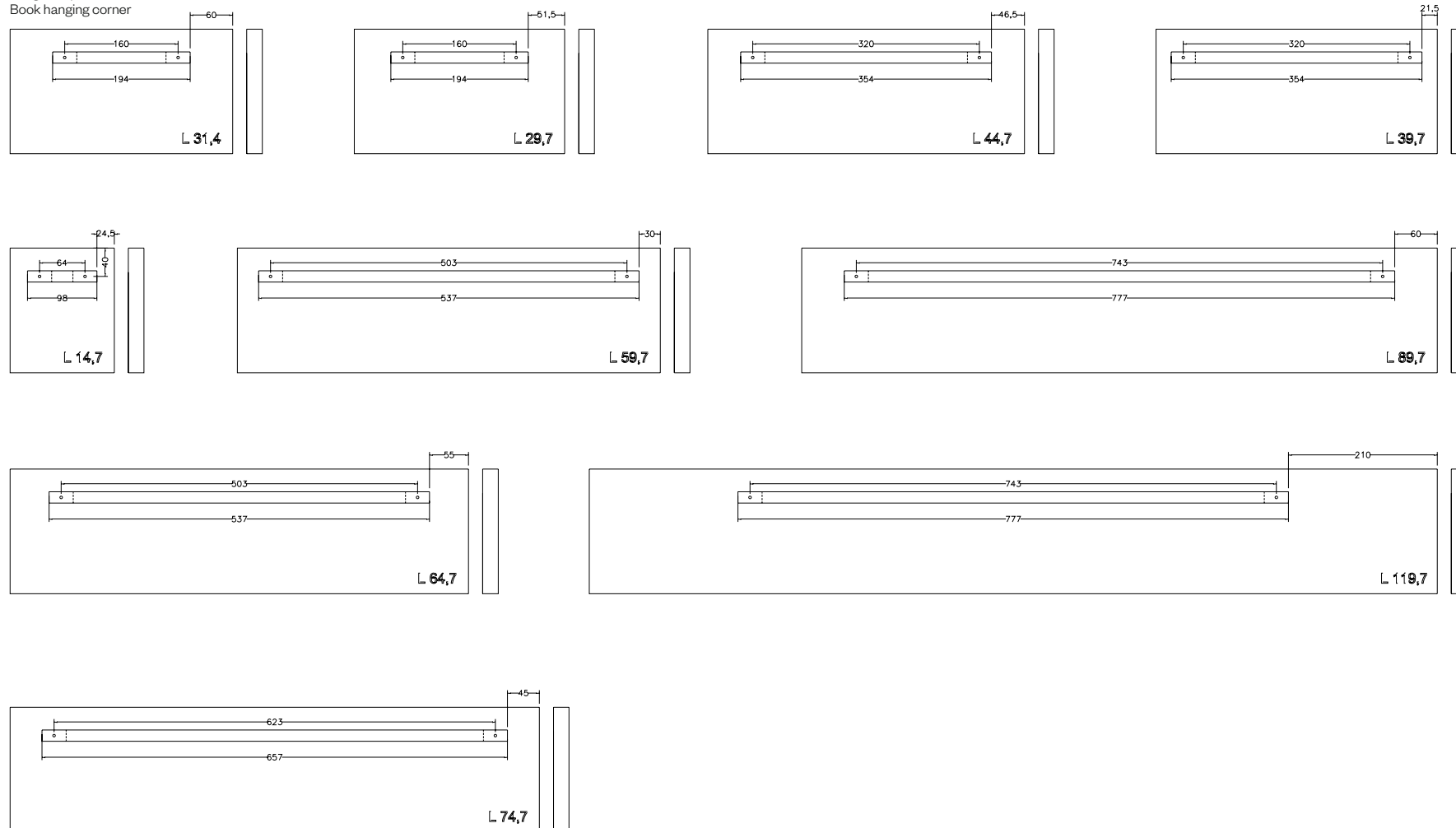

MANIGLIA M31KO

- MANIGLIA HANDLE passo 64 mm
- MANIGLIA HANDLE passo 160 mm
- MANIGLIA HANDLE passo 320 mm
- MANIGLIA HANDLE passo 503 mm
- MANIGLIA HANDLE passo 623 mm
- MANIGLIA HANDLE passo 743 mm

MANIGLIA M32TO

- MANIGLIA HANDLE passo 64 mm
- MANIGLIA HANDLE passo 160 mm
- MANIGLIA HANDLE passo 320 mm
- MANIGLIA HANDLE passo 503 mm
- MANIGLIA HANDLE passo 623 mm
- MANIGLIA HANDLE passo 743 mm

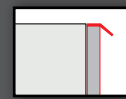

DI SERIE STANDARD



Maniglia 910T finitura titanio
Handle 910T titanium finish

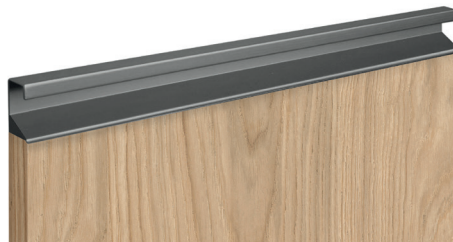

Maniglia 910S finitura silver dark
Handle 910S dark silver

A RICHIESTA ON REQUEST



Maniglia 911S finitura grigio selce
Handle 911S flint grey finish



Maniglia 911D finitura silver dark
Handle 911D dark silver



Maniglia 913T finitura titanio
Handle 913T titanium finish



Maniglia 913S finitura silver dark
Handle 913S dark silver



Maniglia 920T finitura titanio
Handle 920T titanium finish



Maniglia 920S finitura silver dark
Handle 920S dark silver





PENSILI WALL UNITS

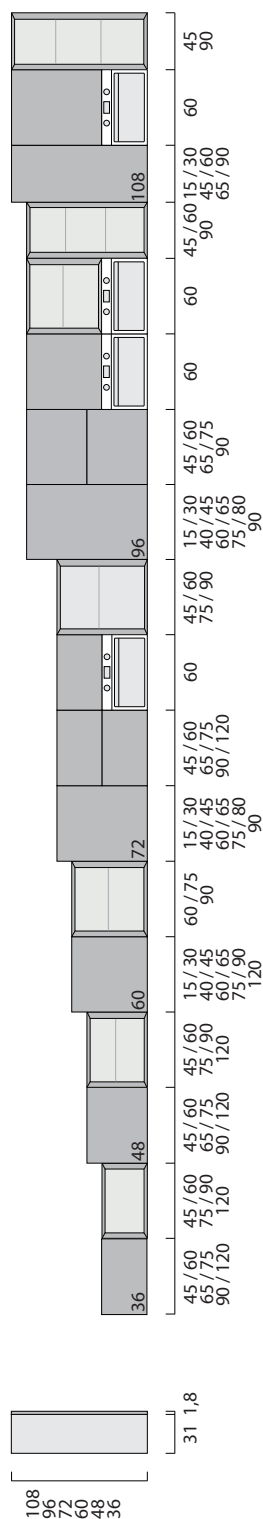

BASI ZOCCOLO H.13

H.13 PLINTH BASE UNITS

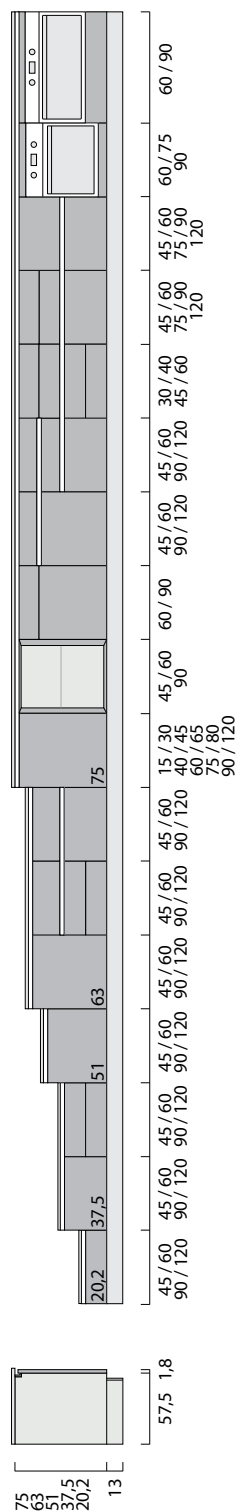

BASI SOSPESE

SUSPENDED BASE UNITS

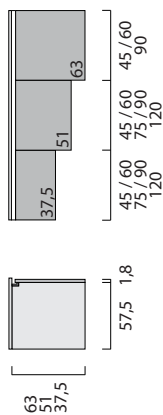

BASI ZOCCOLO H.6

H.6 PLINTH BASE UNITS

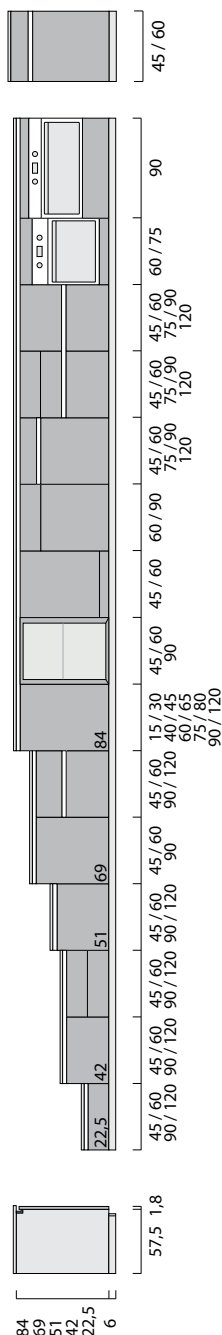

BASI SOSPESE

SUSPENDED BASE UNITS

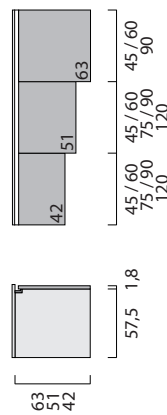



PENSILI WALL UNITS

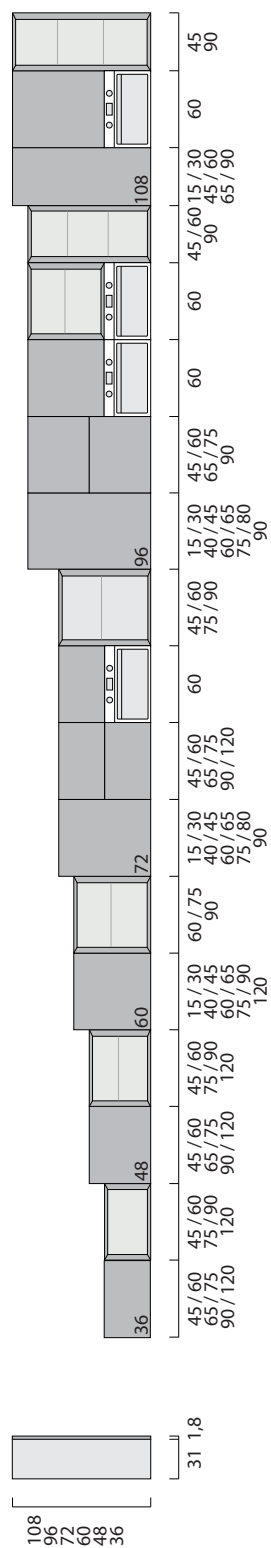

BASI ZOCCOLO H.13 H.13 PLINTH BASE UNITS

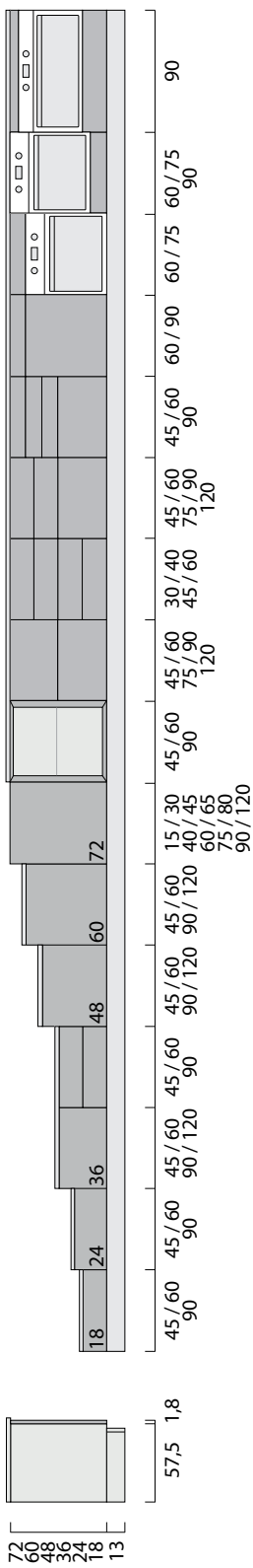

BASI ZOCCOLO H.6 H.6 PLINTH BASE UNITS

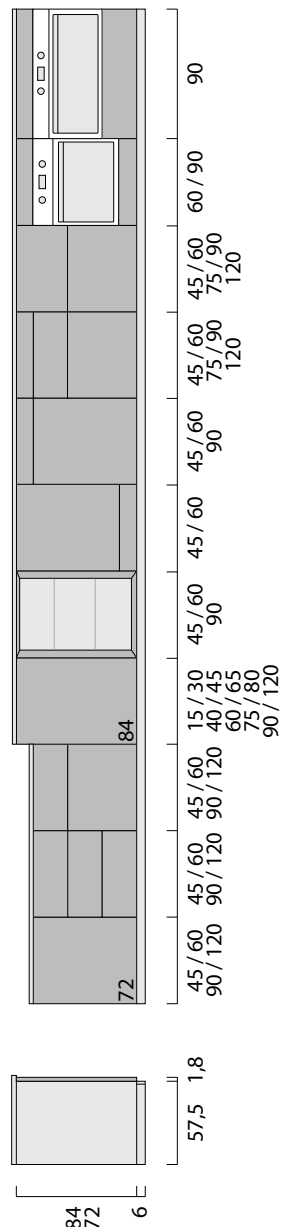

BASI SOSPESE SUSPENDED BASE UNITS

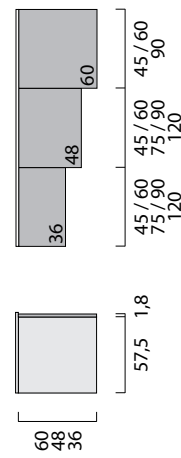

COLONNE ZOCCOLO H.13

H.13 PLINTH COLUMNS

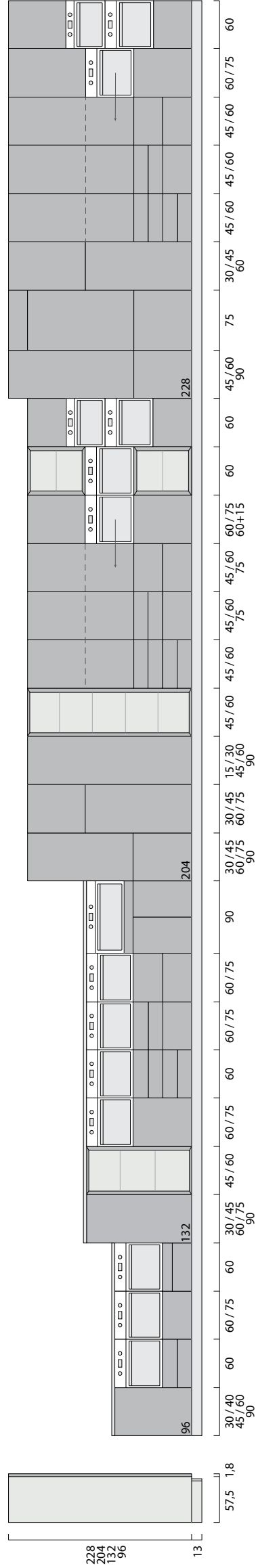

COLONNE ZOCCOLO H.6

H.6 PLINTH COLUMNS

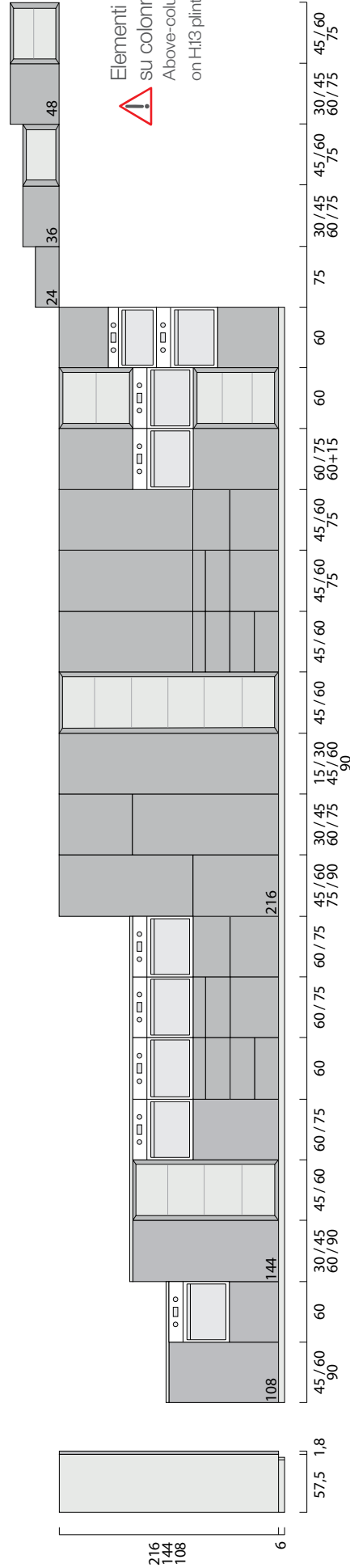

⚠ Elementi sopra colonna validi anche su colonne ZOCCOLO H.13.
Above-column elements also valid on H.13 plinth columns.

ELEMENTI PER LIVING

LIVING ELEMENTS

i COLONNE CON ANTE FINO A TERRA disponibili per piedi H.13 e piedi H.6. Per modullistica disponibile con anta fino a terra vedere relativa sezione del listino. Solo per sistema Bridge.

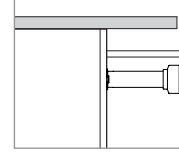

COLUMNS WITH DOOR DOWN TO GROUND available for H.13 feet and H.6 feet. For available elements with door down to ground see respective section in the price list. Only for Bridge system.

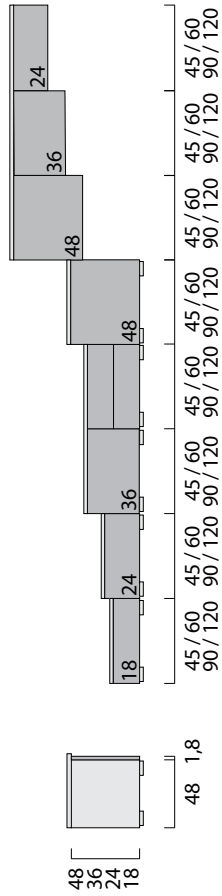

⚠ Per attrezzature interne e meccanismi di apertura vedere relative sezioni nel listino.
For internal equipment and opening mechanisms, see respective sections in the price list.

⚠ Per dimensioni dei singoli frontali vedere relative sezioni nel listino.
For size of individual doors, see respective sections in the price list.



anta sp.18 mm costituita da un pannello composto da particelle in agglomerato di legno (conforme US EPA TSCA Title VI) nobilitato melaminico e bordato in abs o polipropilene.
18 mm thick door made of a agglomerate wood panel (compliant with US EPA TSCA Title VI) melamine coated with ABS or polypropylene edging.

ANTE FINITURA OPACA SOFT DOORS WITH SOFT MATT FINISH

bianco (opz.7447N)

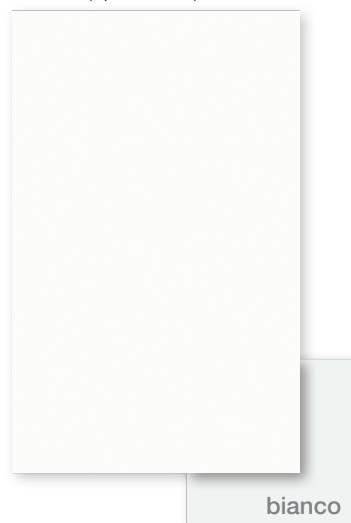

porcellana (opz.7703N)

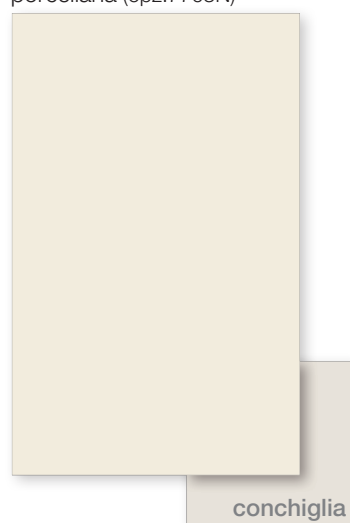

desert (opz.8914N)

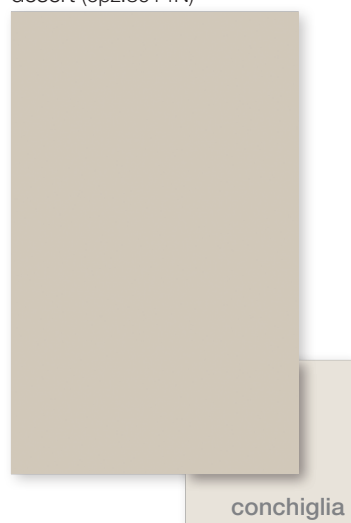

seta antica (opz.7709)



brina (opz.9656)

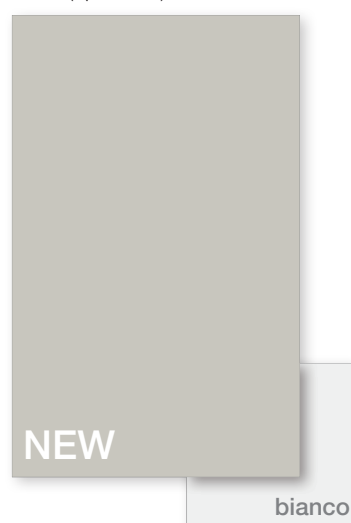

monumento (opz.9657)



uragano (opz.9658)

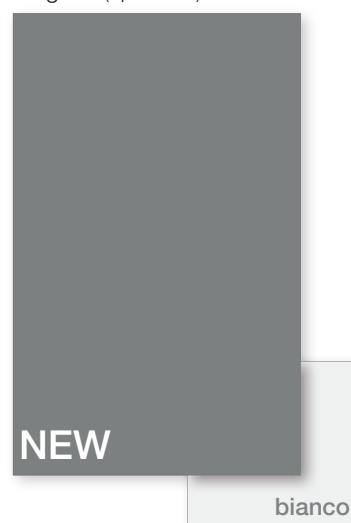

nero (opz.7864)

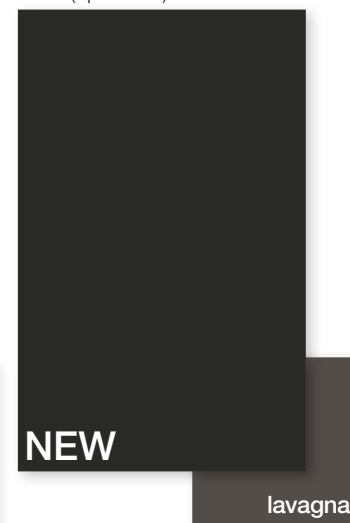

verde giada (opz.8915)

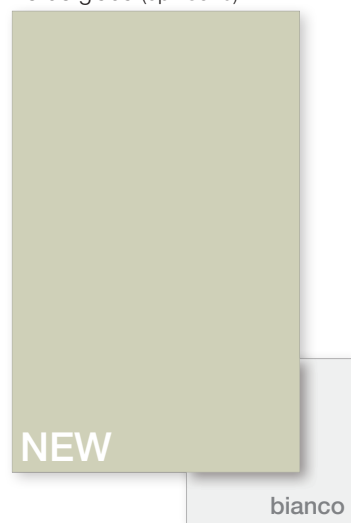

verde rugiada (opz.8404)

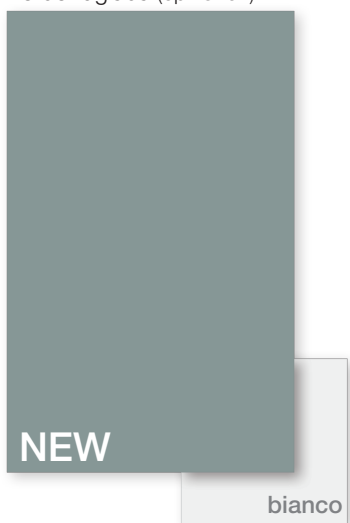

corniola (opz.8125)

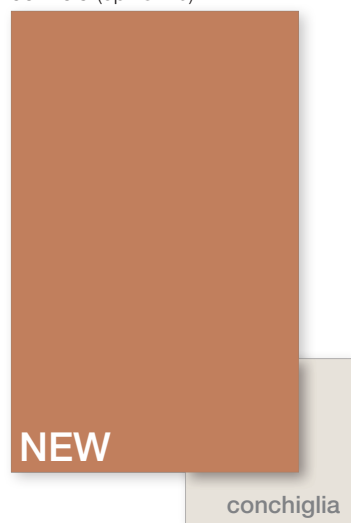

rosso minio (opz.8124)

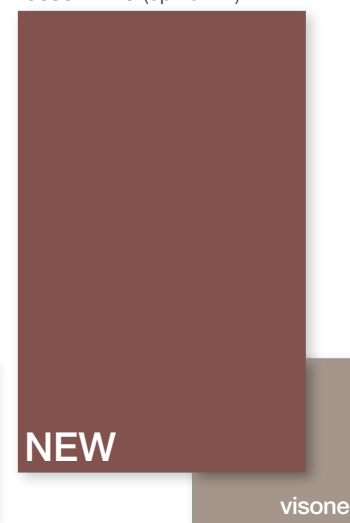

Il Polipropilene è un prodotto di elevata qualità che trasmette al bordo un'alta resistenza ai prodotti acidi, solventi e raggi UV. Inoltre è 100% riciclabile.

Polypropylene is a high-quality product that imparts high resistance to acids, solvents, and UV rays to the edging. In addition, it is 100% recyclable.



Neck cod. KT5

Bridge cod. KT1

Head cod. KT8

ANTE BAMBOO FINITURA OPACA BAMBOO DOORS WITH MATT FINISH

nativo (opz.4601)



i RIGATINO 2D
2D REED

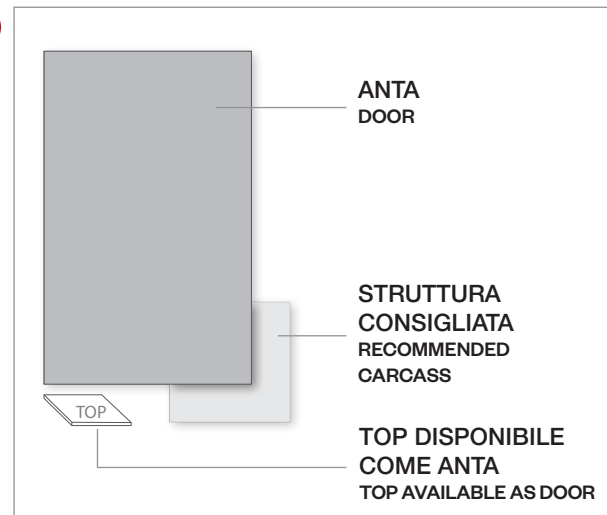

ANTE NOCE FORTUNIO FINITURA OPACA FORTUNIO WALNUT DOORS WITH MATT FINISH

ghiaccio (opz.2372)



barrique (opz.2374)



nuvola (opz.2373)



ANTE EFFETTO CALCE FINITURA MATERICA LIME EFFECT DOORS WITH MATERIC FINISH

sale (opz.7451)



rena (opz.7708)

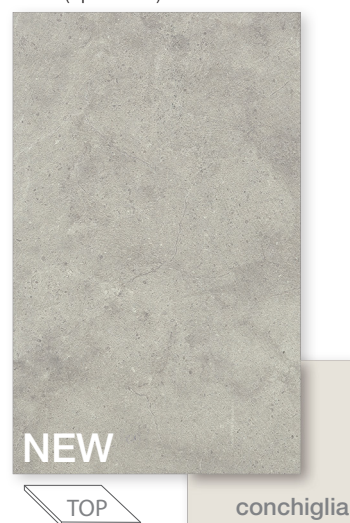

roccia (opz.8877)

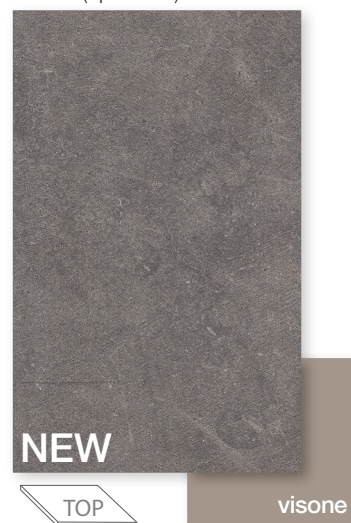

piombo (opz.9649)





ANTE CARAVELLA FINITURA OPACA
CARAVELLA DOORS WITH MATT FINISH

dark (opz.8876)



light (opz.8875)

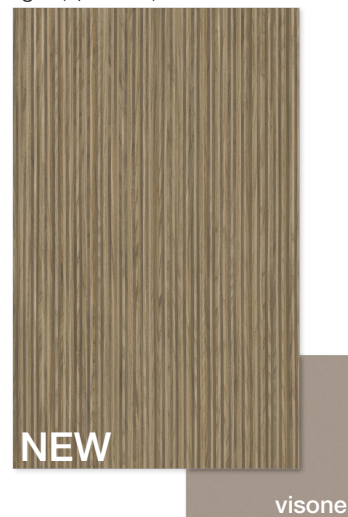

i RIGATINI 2D
2D REEDS

ANTE INTAGLIO EFFETTO LEGNO
WOOD EFFECT CARVED DOORS

miele (opz.8215)

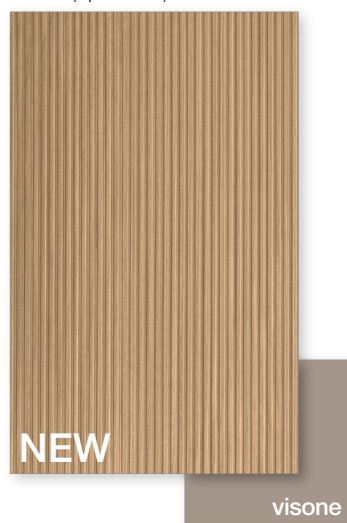

cognac (opz.8878)

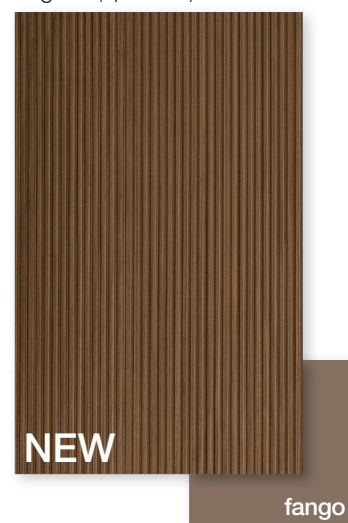

ANTE INTAGLIO EFFETTO PERLATO
PEARL EFFECT CARVED DOORS

silver (opz.9654)

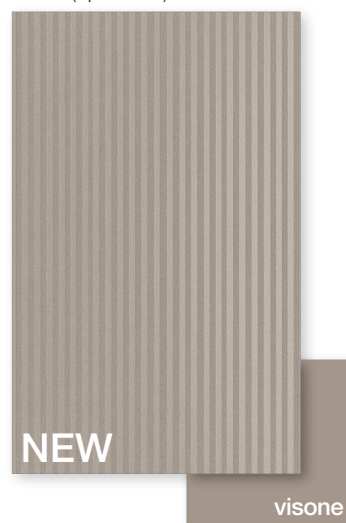

bronze (opz.9655)



i RIGATINI 3D
3D REEDS

ANTE FINITURA SPAZZOLATA
DOORS WITH BRUSHED FINISH

ottone chiaro (opz.7707)

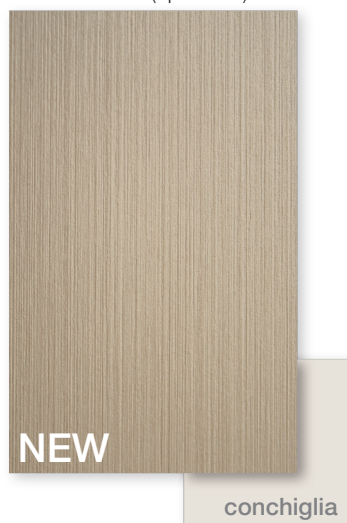

rame brunito (opz.8868)

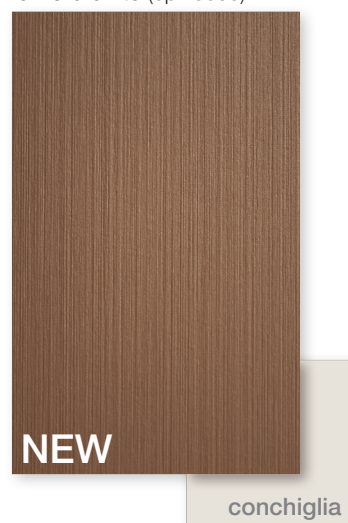

peltro (opz.9666)



ANTE FRASSINO FINITURA OPACA PERFECTSENSE ASH DOORS WITH PERFECTSENSE MATT FINISH

anta sp.18 mm costituita da un pannello composto da particelle in agglomerato di legno (conforme US EPA TSCA Title VI) nobilitato melaminico, verniciato opaco Perfectsense, bordato in abs o polipropilene.

18 mm thick door made of a agglomerate wood panel (compliant with US EPA TSCA Title VI) melamine coated, perfectsense matt painted with ABS or polypropylene edging.

elegant (opz.2409)



dark (opz.2410)





ANTE PIETRA FINITURA MATERICA
STONE DOORS WITH MATERIAL FINISH

pietra fulvus (opz.8867)



pietra musk (opz.8403)



ANTE ROVERE FINITURA OPACA
OAK DOORS WITH MATT FINISH

olio (opz.5323)



botte (opz.5324)



ANTE NOCE FINITURA SEMILUCIDA
WALNUT DOORS WITH SEMI-GLOSS FINISH

brown (opz.2371)



ANTE ROVERE FINITURA MATERICA
OAK DOORS WITH TEXTURED FINISH

tabià (opz.5309)

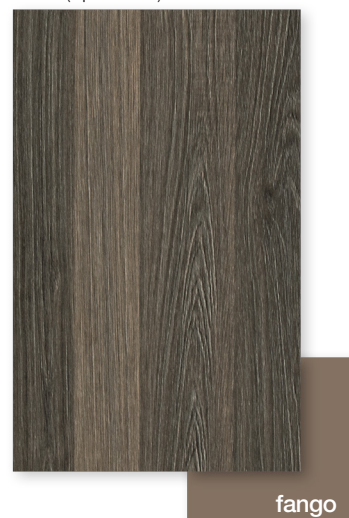

ortisei (opz.5305)



ANTE FINITURA OPACA MARMORIZZATA
DOORS WITH MARBLED MATT FINISH

marmo white yule (opz.9645)

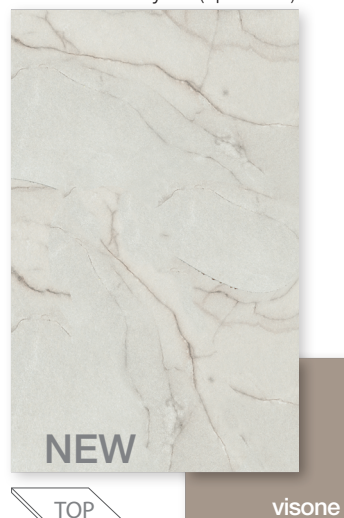

marmo venato grigio (opz.8870)







anta sp.18 mm costituita da un pannello composto da particelle in agglomerato di legno (conforme US PA TSCA Title VI) con fronte esterno laccato super-opaco (3 gloss con trattamento ad eccimeri) o extralucido (95 gloss), ciclo di verniciatura a raggi UV, bordato in 4 lati polipropilene, retro anta in tinta.
18 mm thick door made of a agglomerate wood panel (compliant with US EPA TSCA Title VI) with exterior front in super-matt lacquer (3 gloss with "eccimeri" treatment) or in hi-gloss lacquer (95 gloss), UV ray painting cycle with 4 edges in polypropylene, back door matching.

ANTE FINITURA OPACA
DOORS WITH MATT FINISH

bianco (opz.7405)

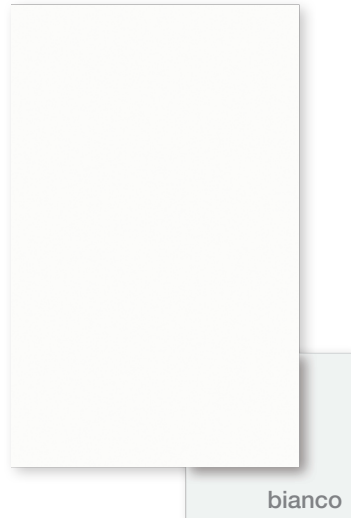

bianco neve (opz.7407)

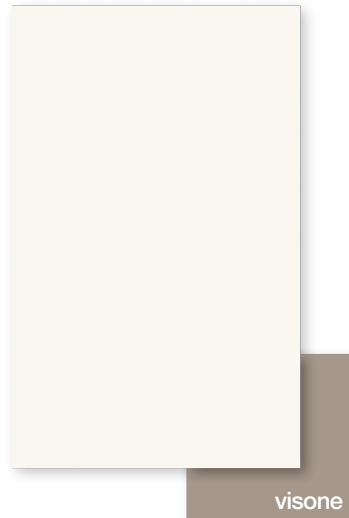

desert (opz.8941)



polvere (opz.9529)

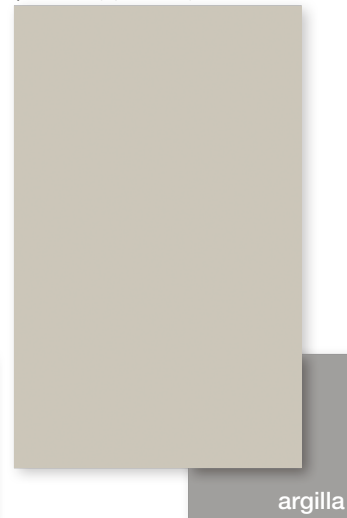

beige colorado (opz.7777)

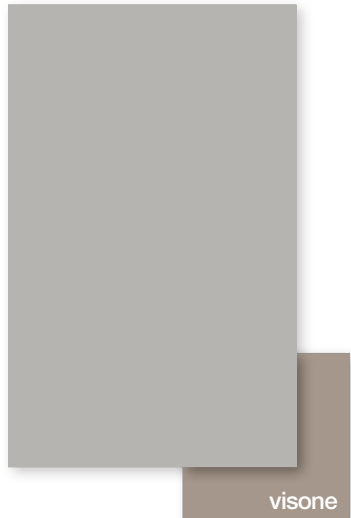

antracite (opz.9558)



nero (opz.7895)



grigio minerale (opz.9523)



blu cobalto (opz.8383)



verde malga (opz.8477)

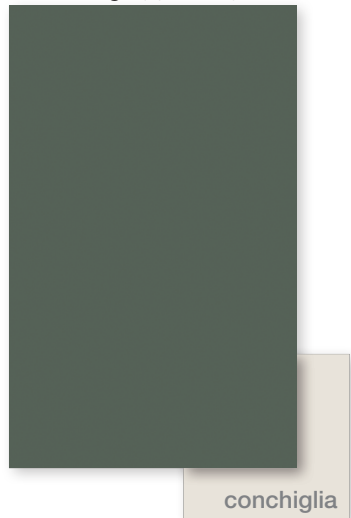

rosso cameo (opz.8160)

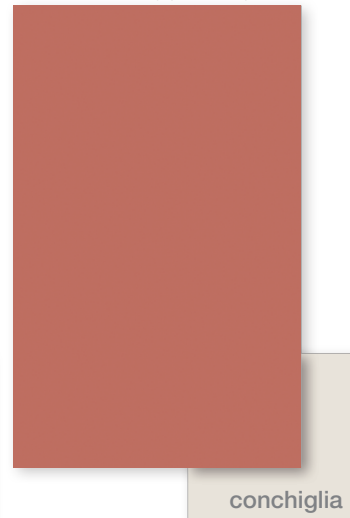

giallo cadmio (opz.8255)

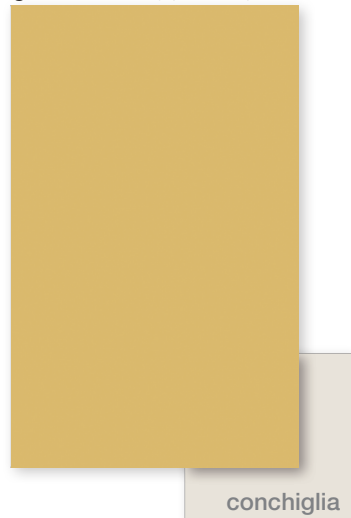

verde nilo (opz.8475)

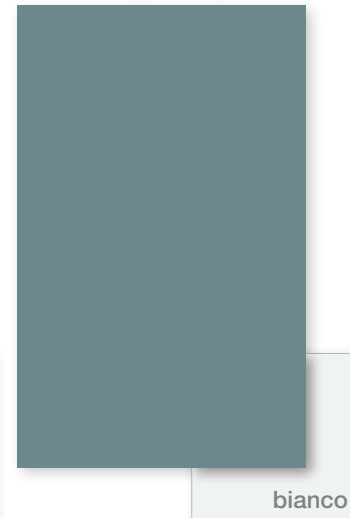

rosso velvet (opz.8168)

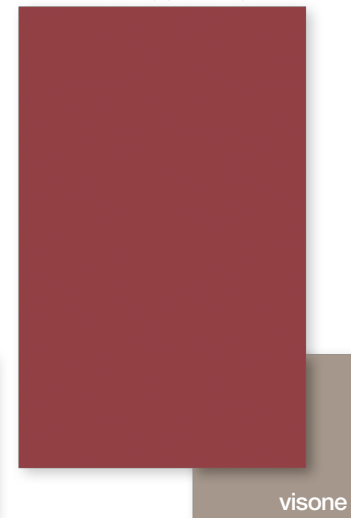

Le ante laccate UV nella finitura opaca, sono sottoposte, nella parte frontale, a un processo di verniciatura attraverso la tecnologia "ECCIMERI". Tale trattamento conferisce alle ante una superficie ULTRA OPACA (3 gloss), con effetto SOFT-TOUCH e una maggiore resistenza al graffio.

UV lacquered doors in matt finish, are subjected to a painting process, in the front side, through "ECCIMERI" technology. This treatment gives the doors an ULTRA MATT surface (3 gloss), with SOFT-TOUCH effect and increased scratch resistance.



Neck cod. KT6
Bridge cod. KT2
Head cod. KT9

ANTE FINITURA LUCIDA DOORS WITH GLOSSY FINISH

bianco (opz.7406)

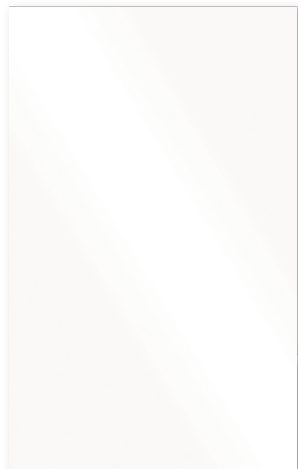

bianco

desert (opz.8942)



conchiglia

polvere (opz.9530)



argilla

antracite (opz.9559)



lavagna

nero (opz.7896)



lavagna

beige colorado (opz.7778)



visone

grigio minerale (opz.9524)



argilla

rosso cameo (opz.8164)



conchiglia



anta sp.18 mm costituita da un pannello composto da particelle in agglomerato di legno (conforme US EPA TSCA Title VI) impiallacciato rovere fiamma verticale WOOD con bordo polipropilene 10/10.

18 mm thick door made of a agglomerate wood panel (US EPA TSCA Title VI compliant) in vertical flame stained oak veneered WOOD with 10/10 polypropylene edge.

ANTE FINITURA IMPIALLACCIATA ROVERE TINTO A PORO APERTO DOORS WITH OPEN PORE STAINED OAK VENEERED FINISH

rovere naturale (opz.5442)
fiamma verticale



conchiglia

rovere grey (opz.5443)
fiamma verticale



conchiglia

rovere moscato (opz.5444)
fiamma verticale



fango

rovere furnè (opz.5445)
fiamma verticale



lavagna

ANTE FINITURA IMPIALLACCIATA ROVERE LACCATO A PORO APERTO DOORS WITH OPEN PORE LACQUERED VENEERED FINISH

rovere bianco (opz.5441)
fiamma verticale



bianco

rovere nero (opz.5446)
fiamma verticale



lavagna



Le ante impiallacciate WOOD sono sottoposte a un processo di verniciatura trasparente mediante tecnologia ad "ECCIMERI".

Tale trattamento conferisce alle ante una superficie ULTRA OPACA (circa 5 gloss), con effetto SOFT-TOUCH e una maggiore resistenza al graffio.

La parte posteriore dell'anta non è soggetta al trattamento sopraindicato, viene rivestita con impiallaccio in tinta ma con caratteristiche differenti rispetto al frontale.

The WOOD veneered door is subject to a transparent painting process using the "ECCIMERI" technology. This treatment gives the doors an ULTRA MATT surface (about 5 gloss), with a SOFT-TOUCH effect and a greater scratch resistance. The rear part of the door is not subject to the above treatment, it is covered with matching veneer wood that has different characteristics than the front.

Neck cod. KT4
Bridge cod. KT0
Head cod. KT7



TELAIO ALLUMINIO FINITURA OPACA

MATT FINISH ALUMINIUM FRAME

DI SERIE: telaio alluminio verniciato titanio sp.18 mm vetro extrachiaro o bronzo

STANDARD: 18 mm th. titanium painted aluminium frame extra-clear or bronze glass



telaio titanio con vetro extrachiaro
(opz.TVTE)
titanium frame with extra-clear glass
(opt.TVTE)

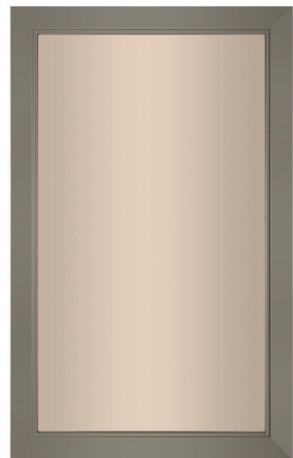

telaio titanio con vetro bronzo
(opz.TVTB)
titanium frame with bronze glass
(opt.TVTB)

A RICHIESTA: telaio alluminio verniciato nero sp.18 mm vetro extrachiaro o fumè

ON REQUEST: 18 mm th. black painted aluminium frame extra-clear or smoked glass



telaio nero con vetro extrachiaro
(opz.NTEX)
black frame with extra-clear glass
(opt.NTEX)



telaio nero con vetro fumè
(opz.NTFT)
black frame with smoked glass
(opt.NTFT)

A RICHIESTA: telaio alluminio verniciato silver dark sp.18 mm vetro extrachiaro o fumè

ON REQUEST: 18 mm th. silver dark painted aluminium frame extra-clear or smoked glass



telaio silver dark con vetro extrachiaro
(opz.DTEX)
silver dark frame with extra-clear glass
(opt.DTEX)



telaio silver dark con vetro fumè
(opz.DTFT)
silver dark frame with smoked glass
(opt.DTFT)

A RICHIESTA: telaio alluminio verniciato rame brunito sp.18 mm vetro extrachiaro o fumè

ON REQUEST: 18 mm th. copper brunched painted aluminium frame extra-clear or smoked glass



telaio rame brunito con vetro
extrachiaro
(opz.RTEX)
copper brunched frame with extra-clear
glass (opt.RTEX)



telaio rame brunito con vetro fumè
(opz.RTFT)
copper brunched frame with smoked glass
(opt.RTFT)

CERNIERA 110° BLUMOTION DI SERIE

STANDARD 110° BLUMOTION HINGES

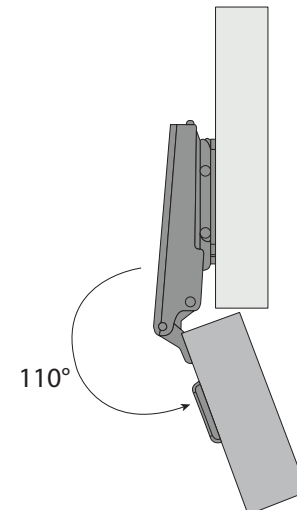
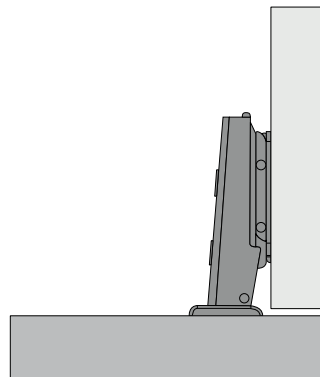
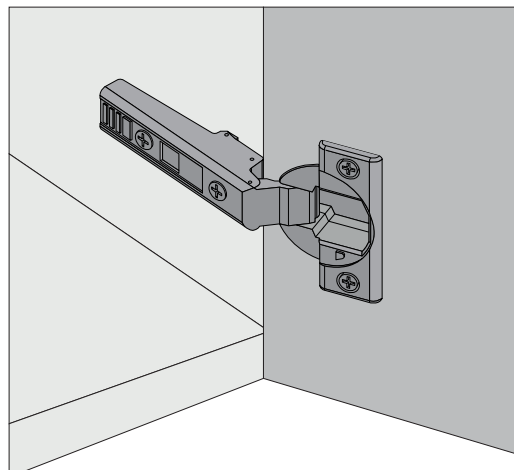

CERNIERA 155° BLUMOTION

155° BLUMOTION HINGES

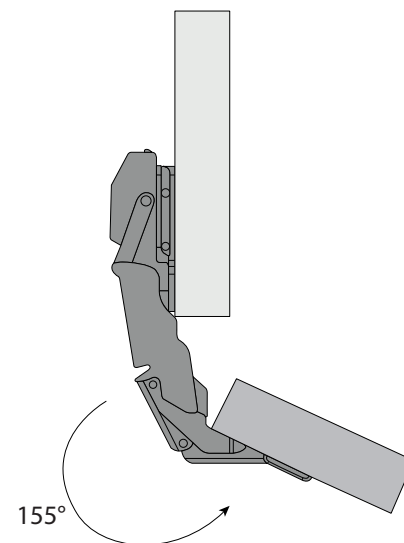
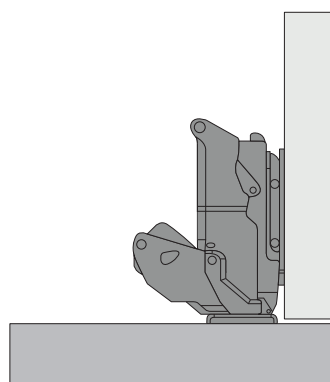
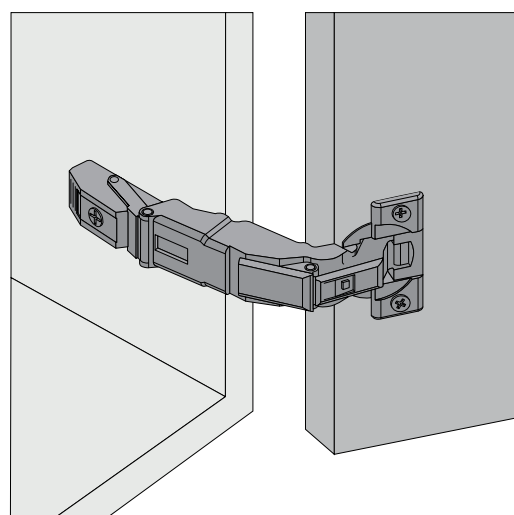

! Le cerniere 155° Blumotion nei pensili sono a richiesta. Sono invece di serie nei pensili colapiatti. Blumotion 155° hinges in wall units are optional. They are, however, standard in the plate rack wall units.

APERTURA A RIBALTA

FLAP OPENING

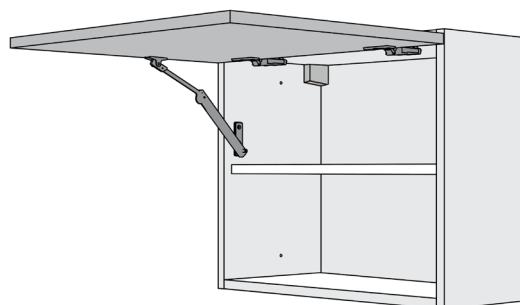

DI SERIE
STANDARD

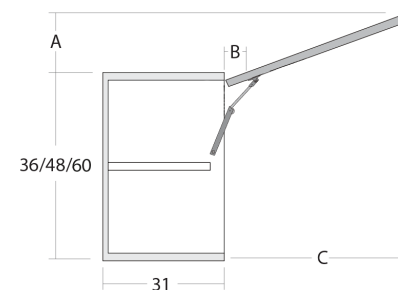

	A	B	C
H 36	10	2,3	46
H 48	13	2,3	61
H 60	17,2	2,3	77,2

APERTURA VERTICALE OBLIQUA

OBLIQUE VERTICAL OPENING

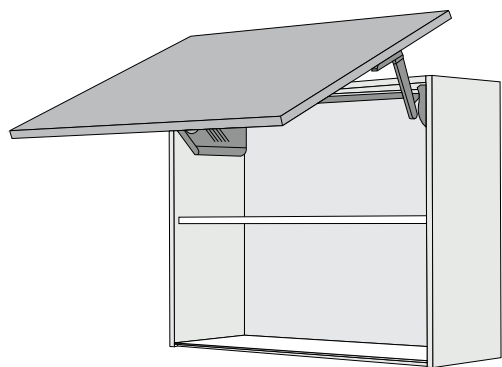

DI SERIE
STANDARD



MOTORIZZATO
SERVO-DRIVE
SERVO-DRIVE
MOTORIZED
(Opz. 007)

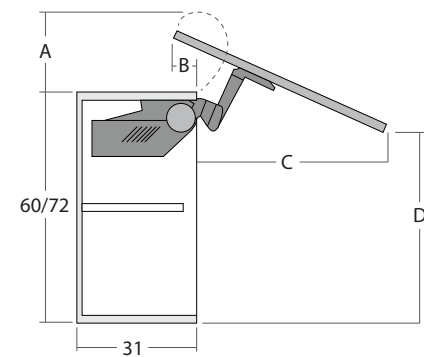

	A	B	C	D
H 60	18	9,6	46,5	53,5
H 72	18	9,6	57	61

APERTURA ANTE A PACCHETTO

LIFT-UP FOLDING OPENING

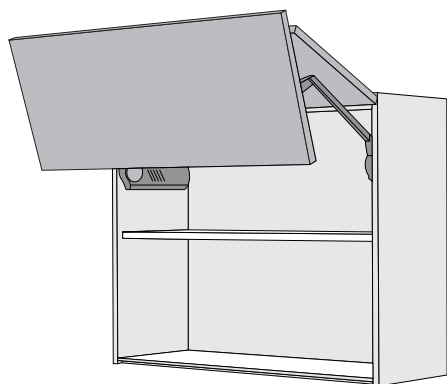

DI SERIE
STANDARD



MOTORIZZATO
SERVO-DRIVE
SERVO-DRIVE
MOTORIZED
(Opz. 007)

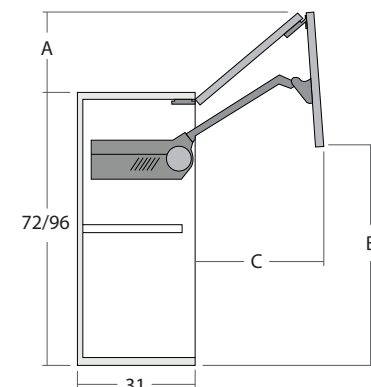

	A	B	C
H 72	19,5	54	41
H 96	24,7	69	53

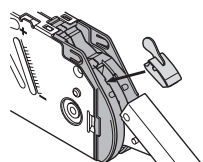

Limitatore angolo di apertura
cod. 5620005
Opening angle limiter
code 5620005

CERNIERA 110° BLUMOTION DI SERIE

STANDARD 110° BLUMOTION HINGES

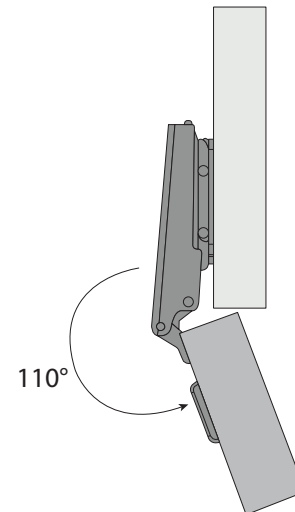
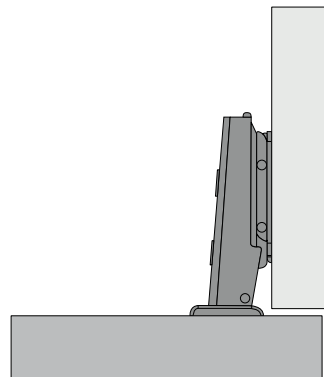
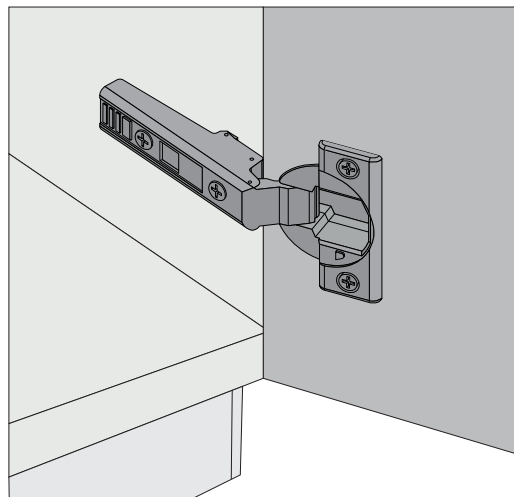

CERNIERA 155° BLUMOTION

155° BLUMOTION HINGES

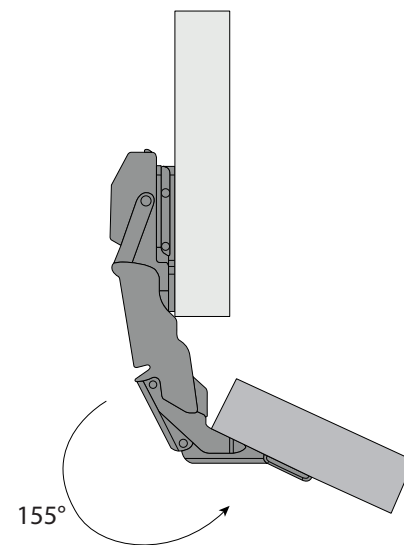
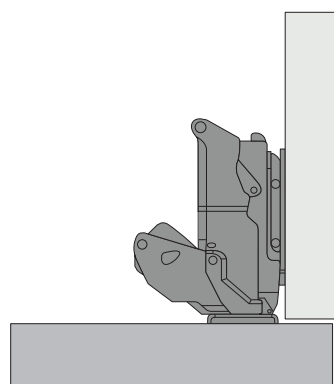
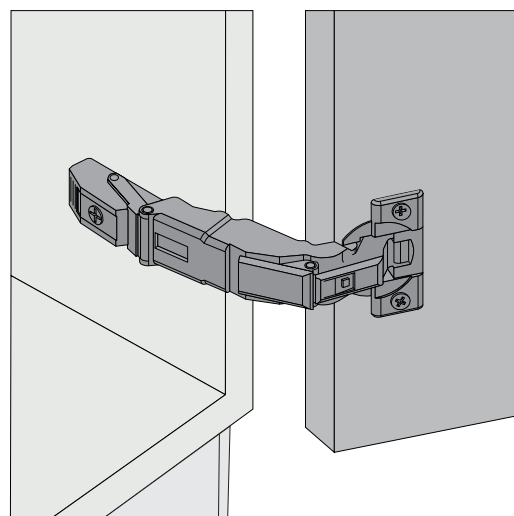

Le cerniere 155° Blumotion sono a richiesta. Sono invece di serie nelle basi angolo 95x95 e 110x110 e nelle basi e colonne con anta più cassetti, cestoni ed accessori estraibili interni. Blumotion 155° hinges are optional. They are, however, standard in the 95x95 and 110x110 corner bases and in the bases and columns with a door plus internal drawers, baskets and extractable accessories.

CERNIERA PILASTRO BLUMOTION

PILLAR BLUMOTION HINGES

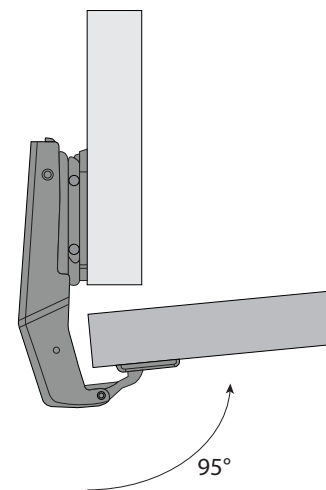
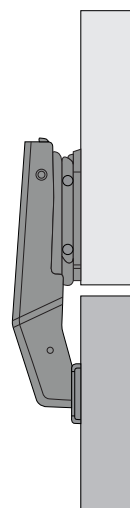
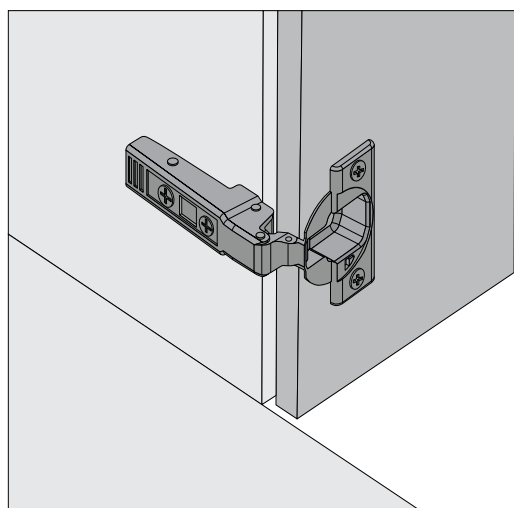

Le cerniere pilastro Blumotion sono di serie nelle basi angolo e nelle colonne angolo. Pillar Blumotion hinges are standard in the corner base units and in the corner columns.

CASSETTI E CESTONI "ANTARO"

"ANTARO" DRAWERS AND BASKETS

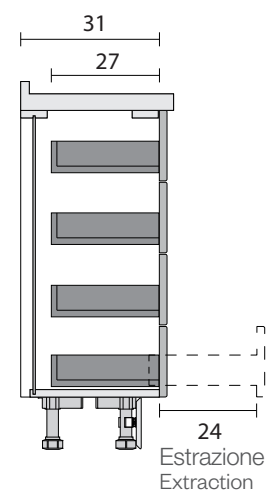
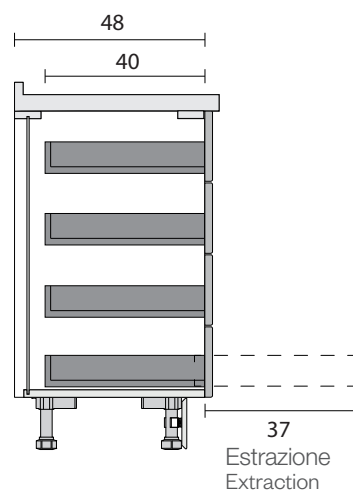
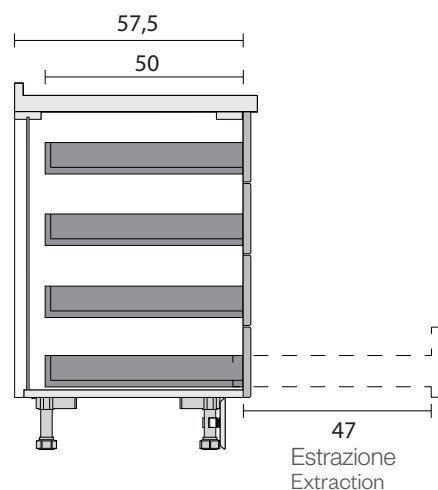
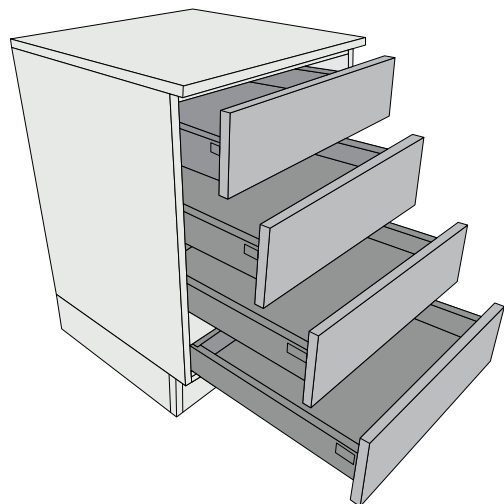

I sistemi "Intivo" garantiscono l'estrazione totale dei cassetti e cestoni e sono equipaggiati con fermo di fine corsa e sistema ad incastro per bloccaggio anti-sganciamento. Nei cassetti e cestoni con larghezza fino a 120 cm la portata dinamica è di 50 kg e 30 kg nelle profondità ridotte. Il movimento silenzioso ed ammortizzato è garantito per oltre 100.000 cicli di apertura/chiusura.

"Intivo" systems ensure full extraction of drawers and baskets and are equipped with end stop and interlocking system for anti-release locking. In drawers and baskets with widths up to 120 cm, the dynamic load capacity is 50 kg and 30 kg in shallow depths. The quiet, damped movement is guaranteed for more than 100,000 opening/closing cycles.

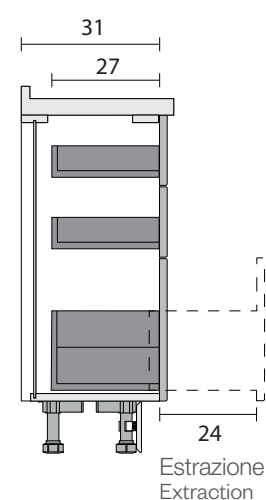
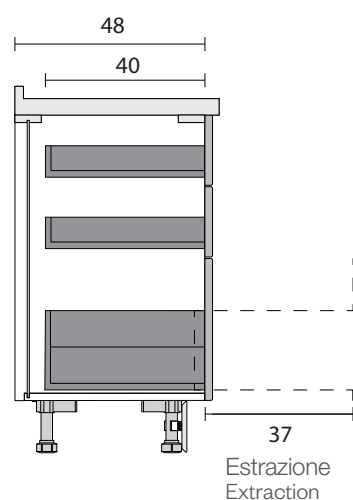
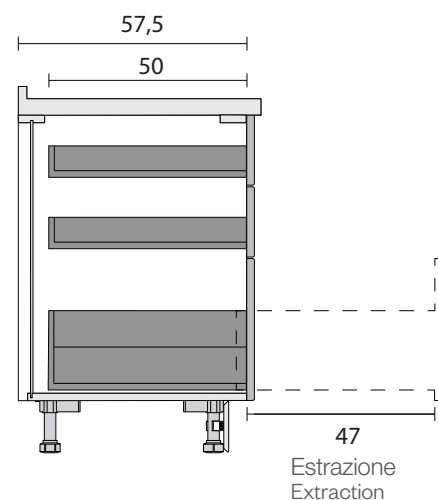
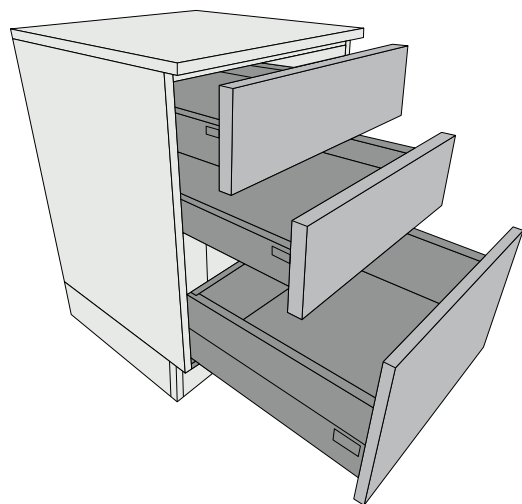

CONSULTA EXTRANET:

- CONSULT ON EXTRANET:
 - Accessori e meccanismi interni
 - Accessories and internal mechanisms



DETTAGLIO CASSETTO E CESTONE "ANTARO"

DETAIL OF "ANTARO" DRAWER AND BASKETS

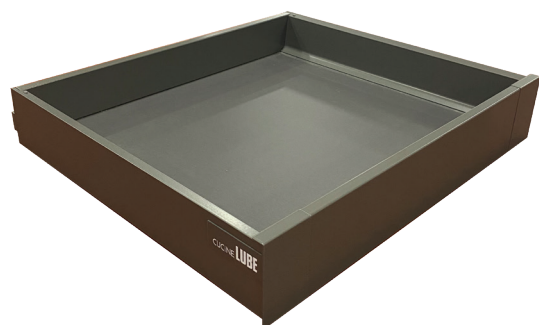

Finitura "Orion Grau"
 "Orion Grau" finish

GRUPPOLUBE



INSIDE-K
 LISTINO 2023

MENSOLE

SHELVES

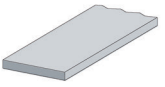
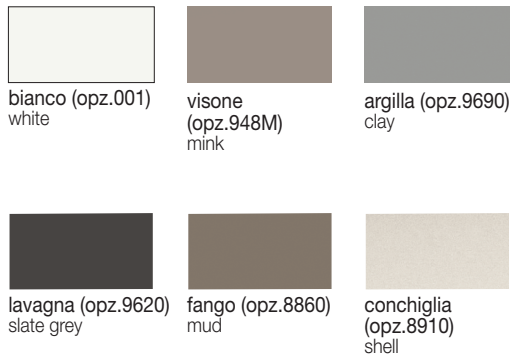
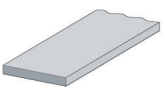
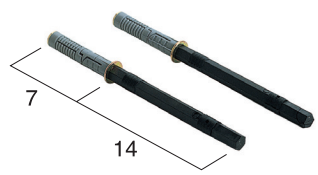
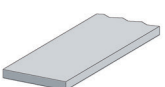
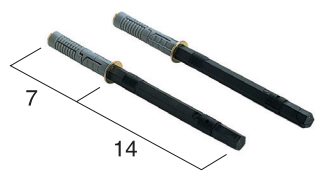
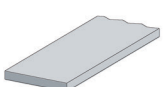
	COD.			COD.			
mensola sp. 3,8 in nobilitato colori strutture L max cm 400 melamine shelf Th. 3.8, colours carcasses max. length 400 cm  Colori strutture Structure colours 				mensola sp. 3,8 in melaminico come anta L max cm 275 N.B.: per i colori vedi pag.28-32 shelf Th. 3.8, melamine same as door Max. length 275 cm Note: for colours see page.28-32  P 31 P 33,1 P 61			
					091523		
					091528		
					091560		
				reggimensola a scomparsa fully integrated shelf bracket  P 31 P 61			
					P 31 P 61		
mensola sp. 3,8 impiallacciata wood come anta L max cm 300 N.B.: per i colori vedi pag.36 shelf Th. 3.8, wood veneered same as door Max. length 300 cm Note: for colours see page.36 				reggimensola a scomparsa fully integrated shelf bracket  P 31 P 33,1 P 61			
					08610400		
mensola sp. 3,8 laccate UV come anta L max cm 300 N.B.: per i colori vedi pag.34-35 shelf Th. 3.8, UV lacquered same as door Max. length 300 cm Note: for colours see page.34-35 							

MOBILI "PLAY"

"PLAY" FURNITURE



COMPOSIZIONE BASSA L 255 (con gola L 260)

LOW COMPOSITION W 255 (with finger rail W 260)



COMPOSIZIONE BASSA L 300 (con gola L 305)

LOW COMPOSITION W 300 (with finger rail W 305)



COMPOSIZIONE BASSA L 255 (con gola L 260)

LOW COMPOSITION W 255 (with finger rail W 260)

COMPONENTI COMPONENTS

Colonna 60 frigo-freezer 230 classe A+

60 cm column fridge-freezer 230 class "A+"

Base 45 2 cassetti e cestone

45 cm base unit with 2 drawers and deep drawer

Base 60 forno statico nero con ventilazione tangenziale di raffreddamento

static oven with orbital cooling ventilation 60 base unit

Piano cottura 60 4 gas inox con valvola di sicurezza

60 cm stainless steel hob with 4 gas burners with safety valve

Sottolavello 90

90 cm sink unit

Lavello ad incasso 86 x 50 1 vasca inox prelucidato

86x50 cm built-in sink with 1 stainless steel bowl

Pensile 45 H 72

45 cm wall unit H 72

Cappa 60 aspirante estraibile H 63 2 motori

60 cm hood slide-out ducting H 63 2 motors

Scolapiatti 90 H 72

90 cm plate rack H 72

Top 195 P 61 in laminato H 4

195 cm laminate worktop D 61 H 4

Asta appendipensili ml 2

2 lm wall unit fixing strip

(Elettrodomestici Beko)
(Beko appliances)

COMPOSIZIONE BASSA L 300 (con gola L 305)

LOW COMPOSITION W 300 (with finger rail W 305)

COMPONENTI COMPONENTS

Colonna 60 frigo-freezer 230 classe A+

60 cm column fridge-freezer 230 class "A+"

Base 60 2 cassetti e cestone

60 cm base unit with 2 drawers and deep drawer

Base 60 forno statico nero con ventilazione tangenziale di raffreddamento

static oven with orbital cooling ventilation 60 base unit

Piano cottura 60 4 gas inox con valvola di sicurezza

60 cm stainless steel hob with 4 gas burners with safety valve

Base 60

60 cm base unit

Sottolavello 60

60 cm sink unit

Lavello ad incasso 86 x 50 1 vasca inox prelucidato

86x50 cm built-in sink with 1 stainless steel bowl

Pensile 60 H 72

60 cm wall unit H 72

Cappa 60 aspirante estraibile H 63 2 motori

60 cm hood slide-out ducting H 63 2 motors

Pensile 60 H 72

60 cm wall unit H 72

Scolapiatti 60 H 72

60 cm plate rack H 72

Top 240 P 61 in laminato H 4

240 cm laminate worktop D 61 H 4

Asta appendipensili ml 4

4 lm wall unit fixing strip

(Elettrodomestici Beko)
(Beko appliances)

COMPOSIZIONE ALTA L 300 (con gola L 305)

HIGH COMPOSITION W 300 (with finger rail W 305)



COMPOSIZIONE BASSA L 360 (con gola L 365)

LOW COMPOSITION W 360 (with finger rail W 365)



COMPOSIZIONE ALTA L 300 (con gola L 305)

HIGH COMPOSITION W 300 (with finger rail W 305)

COMPONENTI

COMPONENTS

Colonna 60 frigo-freezer 230 classe A+

60 cm column fridge-freezer 230 class "A+"

Base 60 2 cassetti e cestone

60 cm base unit with 2 drawers and deep drawer

Base 60 forno statico nero con ventilazione tangenziale di raffreddamento

static oven with orbital cooling ventilation 60 base unit

Piano cottura 60 4 gas inox con valvola di sicurezza

60 cm stainless steel hob with 4 gas burners with safety valve

Base 60

60 cm base unit

Sottolavello 60

60 cm sink unit

Lavello ad incasso 86 x 50 1 vasca inox prelucidato

86x50 cm built-in sink with 1 stainless steel bowl

Pensile 60 H 72

60 cm wall unit H 72

Cappa 60 aspirante estraibile H 63 2 motori

60 cm hood slide-out ducting H 63 2 motors

Pensile 60 H 96

60 cm wall unit H 96

Scolapiatti 60 H 96

60 cm plate rack H 96

Top 240 P 61 in laminato H 4

240 cm laminate worktop D 61 H 4

Mensola 120 P 31 sp. 3,8

120 cm shelf D 31 sp. 3,8

Asta appendipensili ml 4

4 lm wall unit fixing strip

(Elettrodomestici Beko)

(Beko appliances)

COMPOSIZIONE BASSA L 360 (con gola L 365)

LOW COMPOSITION W 360 (with finger rail W 365)

COMPONENTI

COMPONENTS

Colonna 60 frigo-freezer 230 classe A+

60 cm column fridge-freezer 230 class "A+"

Colonna 60 con cestone, forno statico nero con ventilazione tangenziale di raffreddamento

60 column with deep drawer configured for static oven with orbital cooling ventilation

Base 90 2 cassetti + cestone predisposto P.C.

90 cm base unit with 2 drawers + deep drawer configured for hob

Piano cottura 60 4 gas inox con valvola di sicurezza

60 cm stainless steel hob with 4 gas burners with safety valve

Base 60

60 cm base unit

Sottolavello 90

90 cm sink unit

Lavello ad incasso 86 x 50 1 vasca inox prelucidato

86x50 cm built-in sink with 1 stainless steel bowl

Pensile 60 H 72

60 cm wall unit H 72

Cappa 90 sempione acciaio inox satinato + vetro

90 cm sempione hood brushed stainless steel + glass

Pensile 60 H 72

60 cm wall unit H 72

Scolapiatti 90 H 72

90 cm plate rack H 72

Top 240 P 61 in laminato H 4

240 cm laminate worktop D 61 H 4

Top 60 P 61 in laminato H 4

60 cm laminate worktop D 61 H 4

Asta appendipensili ml 4

4 lm wall unit fixing strip

(Elettrodomestici Beko)

(Beko appliances)