

POHOVKA PIUMA

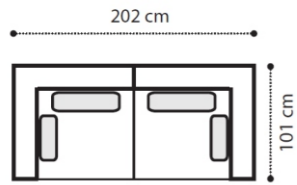

PM/01
Zsx + Zdx

202 x 101 x H. 63 cm

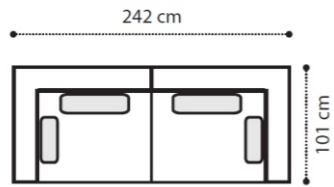

PM/02
Ysx + Ydx

242 x 101 x H. 63 cm

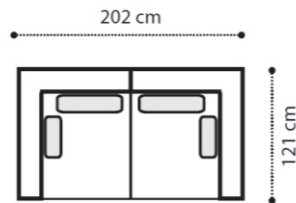

PM/03
Ksx + Kdx

202 x 121 x H. 63 cm

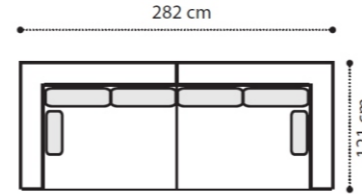

PM/04
Jsx + Jdx

282 x 121 x H. 63 cm

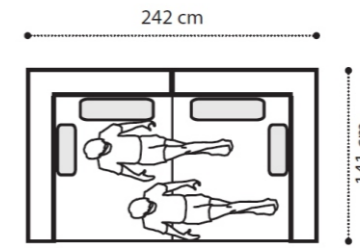

PM/05
Ssx + Sdx

141 x 242 x H. 63 cm

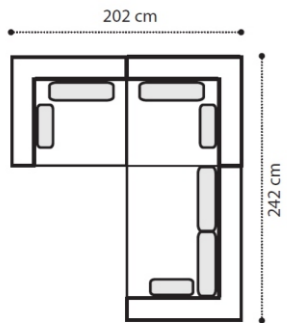

PM/06
Zsx + Zdx + Wdx

202 x 242 x H. 63 cm

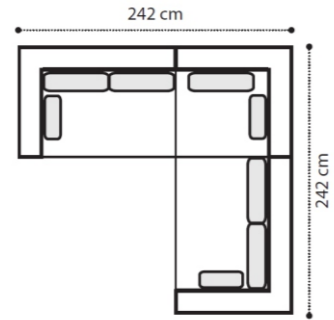

PM/07
Wsx + Zdx + Wdx

242 x 242 x H. 63 cm

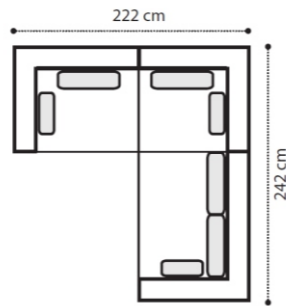

PM/08
Ysx + Zdx + Wdx

222 x 242 x H. 63 cm

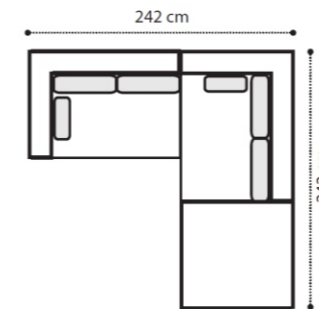

PM/09
Wsx + Wsx + Pouff101

242 x 242 x H. 63 cm

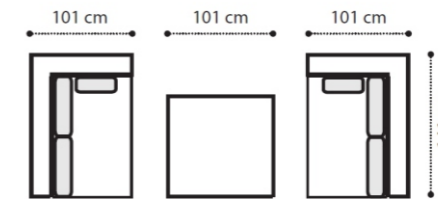

PM/10
Wsx + Pouff101 + Wdx

H. 63 cm

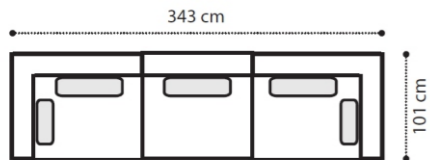

PM/11
Ysx + Rcx + Ydx

343 x 101 x H. 63 cm

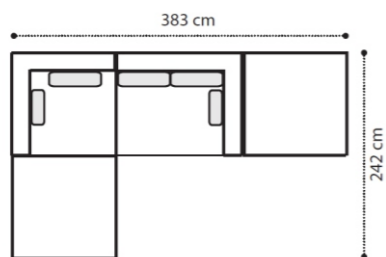

PM/12
Usx + Jdx + Pouff121
+ Pouff121

383 x 242 x H. 63 cm

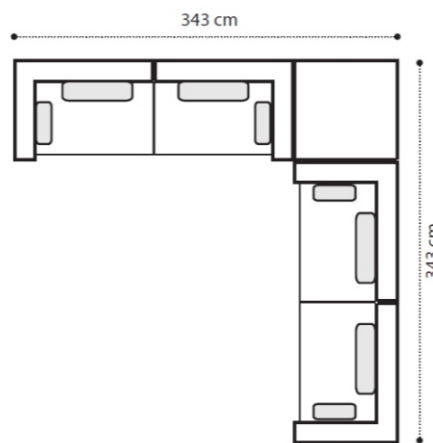

PM/13
Ysx + Ydx + Pouff101
+ Ydx + Ysx

343 x 343 x H. 63 cm

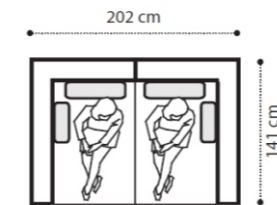

PM/14
Tdx + Tsx

202 x 141 x H. 63 cm

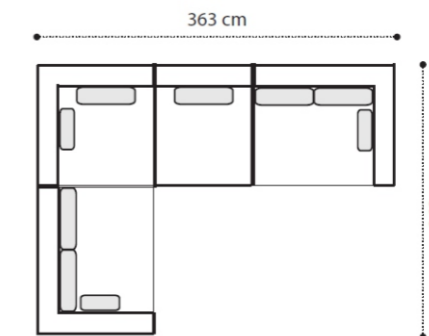

PM/15
Usx + Ocx + Jdx + Jsx

363 x 262 x H. 63 cm

POHOVKA PIUMA

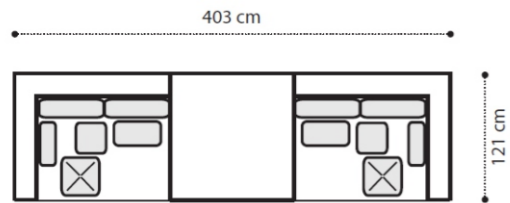

PAG.4 PIUMA
Jsx + Jdx + Pouff121 + 2A + 2B + 2C
note: Cuschions A, B, F in cat. B
403 x 121 x H. 63 cm

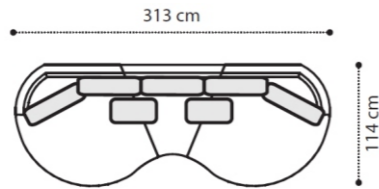

PAG.4 NEW YORK
Bsx + Bdx + 1G + 5M + 2P
note: Cuschions P in cat. E
313 x 114 x H. 95 cm

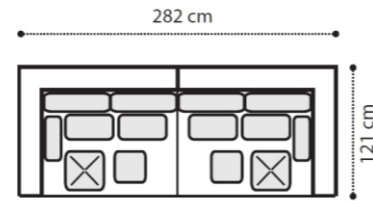

PAG.10 PIUMA
Jsx + Jdx + 2A + 2B + 2C
note: Cuschions B, E in cat. C
282 x 121 x H. 63 cm

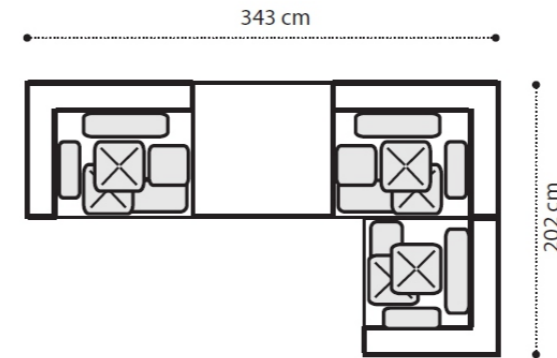

PAG.18 PIUMA
Ysx + Pouff101 + Ydx + Zdx + 6A + 2B + 3C
note: Cuschions A, B in cat. C
343 x 202 x H. 63 cm

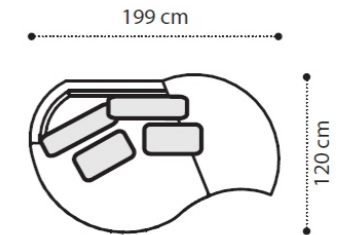

PAG.18 NEW YORK
Bdx + Isx + 2M + 2P
note: Cuschions P in cat. A
199 x 120 x H. 95 cm

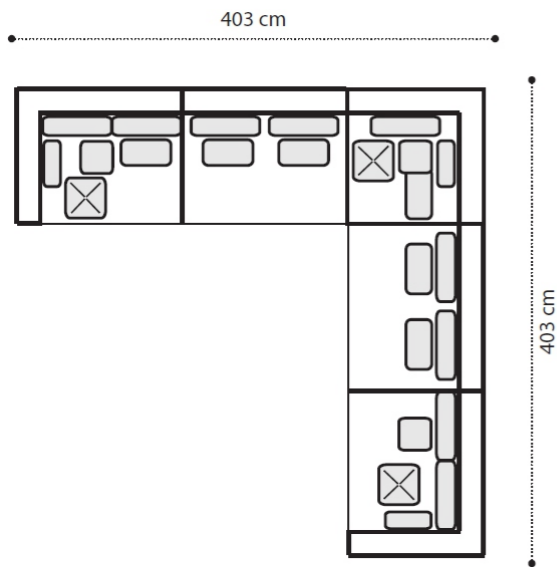

PAG.22 PIUMA
Jsx + 2P + U + Jdx + 3A + 3B + 6C
note: Cuschions C, E in cat. E
403 x 403 x H. 63 cm

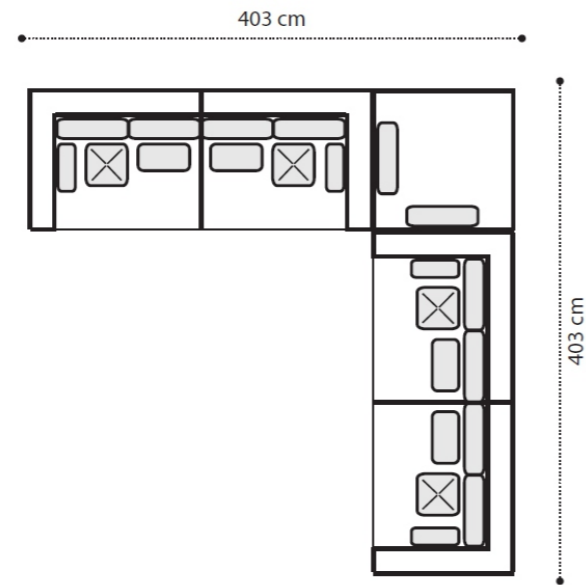

PAG.13 PIUMA
2Jsx + 2Jdx + Pouff121 + 4A + 4C + 2F
note: Cuschions E in cat. C
403 x 403 x H. 63 cm

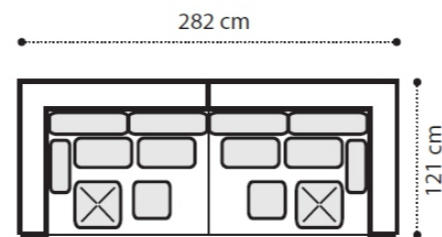

PAG.25 PIUMA
Jsx + Jdx + 2A + 2B + 4C
note: Cuschions C, E in cat. E
282 x 121 x H. 63 cm

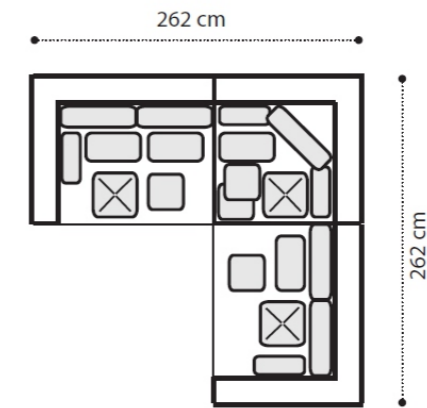

PAG.27 PIUMA
Jsx + U + Jdx + 3A + 4B + 4C
note: Cuschions C, E in cat. E
262 x 262 x H. 63 cm

POHOVKA PIUMA

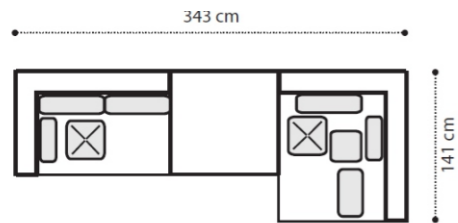

PAG.28 PIUMA

$W_{sx} + P_{ouff101} + S_{dx} + 2A + 1B + 1C$

note: Cuschions A, B, C, F + POUFF101 in cat. C
Cuschions E in cat. F

363 x 141 x H. 63 cm

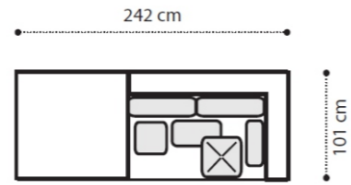

PAG.32-42 PIUMA

$W_{dx} + P_{ouff101} + 1A + 1B + 1C$

note: Cuschions C, E in cat. G

242 x 101 x H. 63 cm

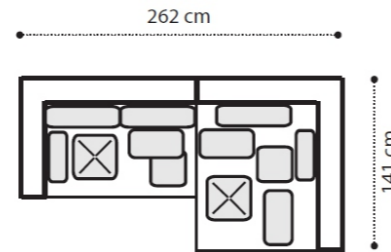

PAG.33 PIUMA

$W_{sx} + S_{dx} + 2A + 2B + 3C$

note: Cuschions A, B, C, F in cat. C
Cuschions E in cat. F

242 x 101 x H. 63 cm

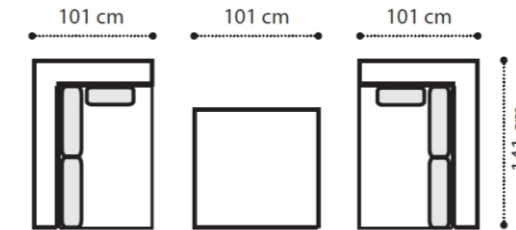

PAG.36-38 PIUMA

$W_{sx} + P_{ouff101} + W_{dx} + 2A + 2B + 2C$

note: Cuschions A, B in cat. C
Cuschions E + POUFF101 in cat. G

H. 63 cm

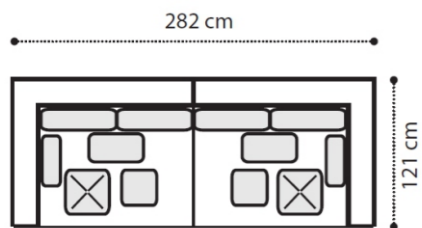

PAG.40-43 PIUMA

$J_{sx} + J_{dx} + 2A + 2B + 2C$

note: Cuschions C, E in cat. G

282 x 121 x H. 63 cm

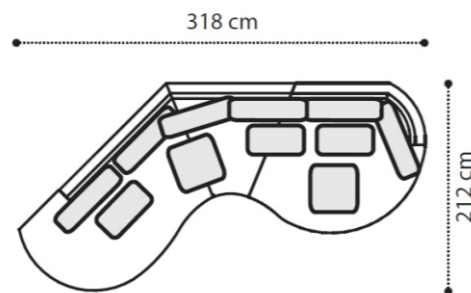

PAG.47 NEW YORK

$A_{dx} + B_{sx} + 1F + 6M + 3P + 2Q$

note: Cuschions M in cat. B

318 x 212 x H. 95 cm

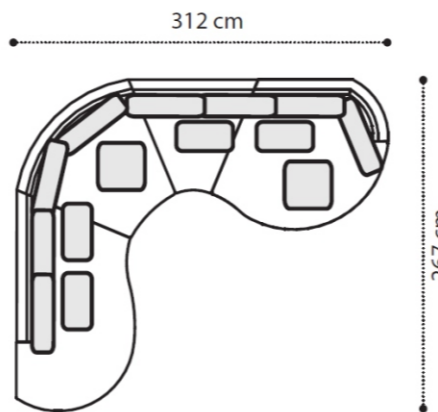

PAG.48 NEW YORK

$A_{dx} + B_{sx} + 1E + 1F + 8M + 4P + 2Q$

note: Cuschions M in cat. B

318 x 212 x H. 95 cm

POHOVKA PIUMA

DEPTH: 101 CM

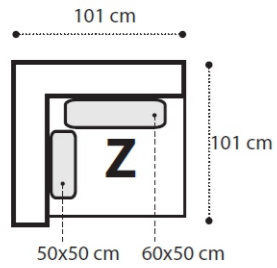

DX/SX: 101 x 101 x H. 63 cm

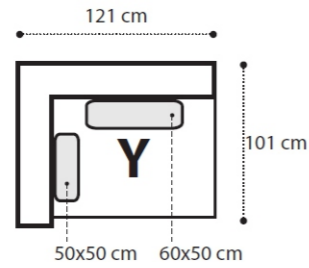

DX/SX: 121 x 101 x H. 63 cm

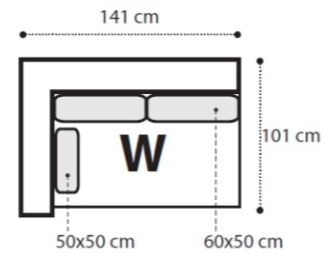

DX/SX: 141 x 101 x H. 63 cm

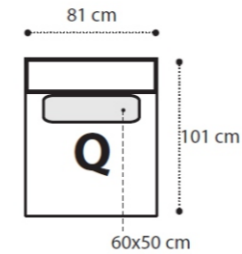

CX: 81 x 101 x H. 63 cm

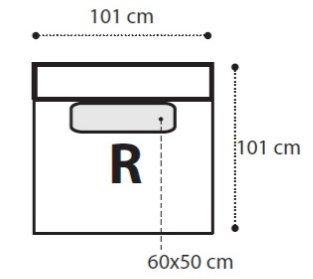

CX: 101 x 101 x H. 63 cm

DEPTH: 121 CM

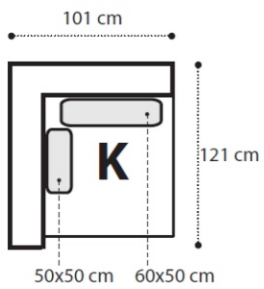

DX/SX: 101 x 121 x H. 63 cm

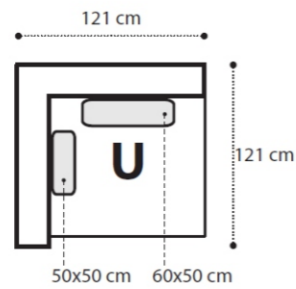

DX/SX: 121 x 121 x H. 63 cm

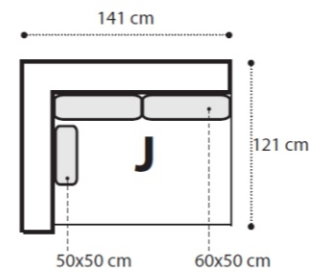

DX/SX: 141 x 121 x H. 63 cm

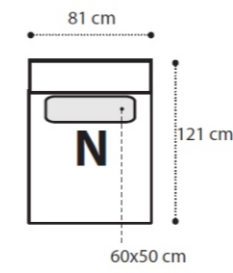

CX: 81 x 121 x H. 63 cm

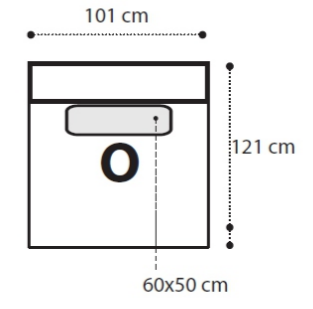

CX: 101 x 121 x H. 63 cm

DEPTH: 121 CM

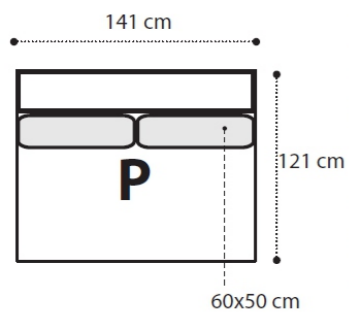

CX: 141 x 121 x H. 63 cm

DEPTH: 141 CM

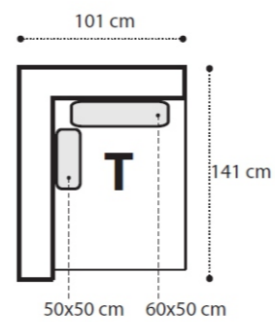

DX/SX: 101 x 141 x H. 63 cm

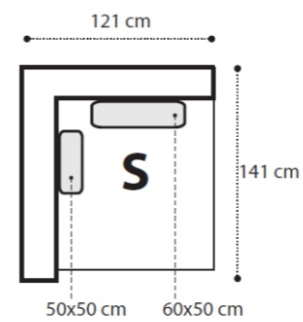

DX/SX: 121 x 141 x H. 63 cm