

SOFA COLLECTION

HAND MADE IN ITALY SINCE 1990



felis
SOFT LIVING



HAND MADE IN ITALY SINCE 1990

Da oltre 30 anni in Felis si incontrano la tradizione dei più alti saperi artigiani e la costante ricerca dell'innovazione. La nostra è una storia di specialisti, legata in modo esclusivo agli imbottiti di qualità. Una scelta rigorosa, che ci permette di offrirvi un'ampia gamma di divani, divani letto e letti, curati nel design e duraturi nel tempo. Una vera oasi di benessere.

At Felis for over 30 years the tradition of the finest craftsmen's skill has gone hand in hand with constant research into innovation. Our story is one of specialists associated exclusively with high quality upholstery products. This rigorous choice enables us to offer you a wide range of meticulously designed sofas, sofa beds and beds that last over time. A true haven of well-being.

Depuis plus de 30 ans chez Felis vous rencontrez la tradition des plus savants artisans et la recherche d'innovation constante. Notre histoire est une histoire de spécialistes, liée de façon exclusive aux rembourrés de qualité. Un choix rigoureux qui nous permet de vous offrir une ample gamme de convertibles, canapés et lits, soignés dans le design et durables dans le temps. Une vraie oasis de bien-être.

Seit mehr als 30 Jahren verbindet Felis die Tradition hochwertiger Handwerkskunst mit ständigem Streben nach Innovation. Unsere Unternehmensgeschichte ist die eines Spezialisten, denn beschäftigen wir uns ausschließlich mit Qualitätspolstermöbeln. Eine konsequente Entscheidung, die es uns ermöglicht, ein umfassendes Sortiment Sofas, Schlafsofas und Betten anzubieten, die sorgfältig entworfen wurden und lange halten. Eine wahre Oase des Wohlbefindens.



HAND MADE IN ITALY

Nasce nel 2020 il nuovo stabilimento di oltre 35.000 mq dotato delle migliori tecnologie disponibili applicabili all'imbottito, con 2.000 mq di showroom aperto al pubblico.

Le nouvel établissement de plus de 35.000 m² naît en 2020, doté des meilleures technologies disponibles des rembourrés, et avec 2000 m² de salle d'exposition ouverte au public.

The new factory was founded in 2020 and with its 35.000 sqm is equipped with the best available technologies applying to padded beds and a showroom of 2.000 sqm open to public.

Das neue Werk mit einer Fläche von 35.000 m² wurde 2020 eröffnet; es ist mit den besten, für Polstermöbel erhältlichen Technologien ausgestattet und beinhaltet einen 2.000 m² großen Ausstellungsbereich, der auch der Öffentlichkeit zugänglich ist.





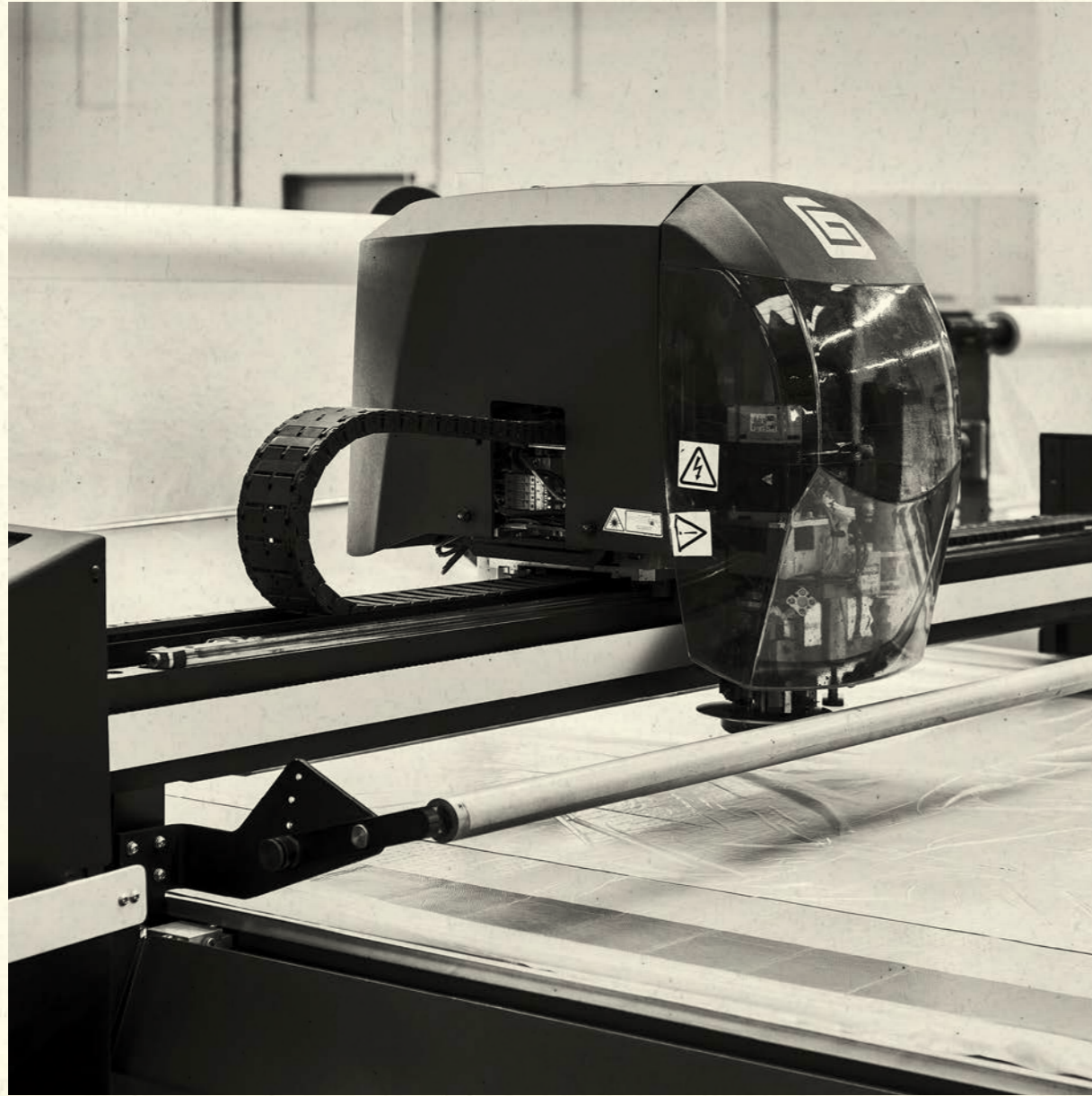









SOFA COLLECTION

Per ogni modello, un programma completo composto da divani, poltrone e pouf tutti completamente sfoderabili, con la possibilità di scegliere tra oltre 500 varianti di tessuto: dalla microfibra alle fibre naturali, dagli antimacchia al trattamento EasyClean, dalle fantasie stampate alle trame complesse. Grazie a un'ampia gamma di soluzioni tecniche, tecnologiche, estetiche e funzionali, gli imbottiti Felis offrono la risposta per ogni esigenza.

Each model features a complete program consisting of sofas, armchairs and ottomans, all with completely removable covers, and a choice of more than 500 different fabrics: from microfiber to natural fibers, from stain resistant to EasyClean treatment, from printed patterns to complex weaves. A wide range of technical, technological, aesthetic and functional solutions makes Felis padded furniture the answer to all your requirements.

Pour chaque modèle, un programme complet composé de canapés, fauteuil et poufs tous entièrement déhoussables, avec la possibilité de choisir entre 500 variantes de tissus: de la microfibre aux fibres naturelles, des anti tâches au traitement EasyClean, des fantaisies imprimées aux tissages complexes.

Grâce à une ample gamme de solutions techniques, technologiques, esthétiques et fonctionnelles, les rembourrés Felis offrent la réponse à chaque exigence.

Für jedes Modell ein komplettes Sortiment an Sofas, Sesseln und Poufs mit völlig abnehmbaren Bezügen, mit der Möglichkeit, aus über 500 Stoffvarianten zu wählen: von Mikrofaser bis zu Naturfasern, von schmutzabweisend bis zu EasyClean-Behandlung, von gedruckten Mustern bis zu komplexen Texturen. Ein breites Spektrum an technischen, technologischen, ästhetischen und funktionellen Lösungen gewährleistet, dass die Polstermöbel Felis allen Anforderungen gerecht werden.

HAND MADE IN ITALY SINCE 1990



→ **Soft Living**

196	All-in	340	<i>Tech. info.</i>
250	Angel	342	<i>Tech. info.</i>
122	Capitol	346	<i>Tech. info.</i>
106	Conrad	348	<i>Tech. info.</i>
138	Float	352	<i>Tech. info.</i>
224	Glove	354	<i>Tech. info.</i>
152	Gravity	360	<i>Tech. info.</i>
262	Icon	362	<i>Tech. info.</i>
238	Kensington	364	<i>Tech. info.</i>
182	Larson	370	<i>Tech. info.</i>
58	Limitless	374	<i>Tech. info.</i>
22	Muffin	363	<i>Tech. info.</i>
270	Nemo	378	<i>Tech. info.</i>
80	Pantheon	380	<i>Tech. info.</i>
166	Platform	386	<i>Tech. info.</i>
32	Reverso	390	<i>Tech. info.</i>
214	Vibe	394	<i>Tech. info.</i>

→ **Armchair & Complementi**

278	Clair	344	<i>Tech. info.</i>
324	Flamingo	350	<i>Tech. info.</i>
284	Lizzie	344	<i>Tech. info.</i>
304	Love & Story	376	<i>Tech. info.</i>
326	Nemesi	377	<i>Tech. info.</i>
322	Pills	382	<i>Tech. info.</i>
316	Prince	388	<i>Tech. info.</i>
310	Sigmund	392	<i>Tech. info.</i>
296	Tubes	393	<i>Tech. info.</i>
290	Wendy	344	<i>Tech. info.</i>

→ **Cushions & Pouf**

332	Cushions	396	<i>Tech. info.</i>
336	Pouf	404	<i>Tech. info.</i>

Soft Living



Muffin p.22
tech. info 363



Reverso p.32
tech. info 390



Limitless p.58
tech. info 374



Pantheon p.80
tech. info 380



Conrad p.106
tech. info 348



Capitol p.122
tech. info 346



Float p.138
tech. info 352



Gravity p.152
tech. info 360



Platform p.166
tech. info 386



Larson p.182
tech. info 370



All-in p.196
tech. info 340



Vibe p.214
tech. info 394



Glove p.224
tech. info 354



Kensington p.238
tech. info 364



Angel p.250
tech. info 342



Icon p.262
tech. info 362



Nemo p.270
tech. info 378

Armchair & Complementi



Clair p.278
tech. info 344



Lizzie p.284
tech. info 344



Wendy p.290
tech. info 344



Tubes p.296
tech. info 393



Love & Story p.304
tech. info 376



Sigmund p.310
tech. info 392



Prince p.316
tech. info 388



Pills p.322
tech. info 382



Flamingo p.324
tech. info 350



Nemesi p.326
tech. info 377

Cushions & Pouf



Cushions p.332
tech. info 396



Pouf p.336
tech. info 404

Muffin

Tre soli elementi: una poltroncina, una chaise longue e un pouf. Tre componenti che, combinati insieme, generano una magica alchimia. Prendono così forma mille composizioni, mille storie diverse da raccontare. Sempre però a lieto fine: grazie alla dolce morbidezza delle sue forme, nelle quali immergersi e lasciarsi coccolare, con Muffin "vissero tutti felici e contenti".

Just three elements: an armchair, a chaise longue and a pouf. Three parts that when combined create a magical alchemy. Producing a myriad of layouts and different stories to tell. All with a happy ending, however, thanks to the softness of the shapes - a place where you can stretch out and relax - everyone 'lives happily ever after' with Muffin.

Seulement trois éléments: un fauteuil, une méridienne et un pouf. Trois composants qui, combinés entre eux, génèrent une alchimie magique. Ainsi, mille compositions prennent forme, mille histoires différentes à raconter. Mais toujours avec une fin heureuse: grâce à la douceur de ses formes, dans lesquelles plonger et se laisser dorloter, avec Muffin «ils vécurent tous heureux».

Drei einzelne Elemente: Ein kleiner Sessel, eine Chaiselongue und ein Sitzhocker. Drei Komponenten, die zusammen eine magische Alchemie erzeugen. So nehmen tausend Kompositionen, tausend Geschichten, die zu erzählen sind, Form an. Geschichten, die immer ein gutes Ende nehmen: Dank der süßen Weichheit ihrer Formen, in die man sich fallen lassen und einkuscheln kann, mit Muffin „lebten sie glücklich und zufrieden bis ans Ende“.







Ogni elemento del programma Muffin è pensato anche per essere indipendente. Come la comoda e versatile poltroncina, perfetta per ogni ambiente.

All the elements in the Muffin program are designed to be used individually. Such as the highly versatile and comfortable armchair that is perfect in any setting.

Chaque élément du programme Muffin est également pensé pour être indépendant. Comme le fauteuil confortable et polyvalent, parfait pour n'importe quel espace.

Jedes Element des Programms Muffin wurde so gestaltet, dass es unabhängig von den anderen Elementen aufgestellt werden kann. Wie der bequeme und vielseitige Sessel, perfekt für jedes Ambiente.



Combinando a piacere i tre moduli, è possibile dare vita al proprio divano ideale, con profondità di seduta diverse e configurazioni che vanno dalla più classica alla più creativa.

Combine the three modules as you please to create your ideal sofa, featuring different seat depths and layouts, ranging from ultra-classic to ultra-creative.

En combinant les trois modules à volonté, il est possible de créer votre canapé idéal, avec différentes profondeurs d'assise et des configurations allant de la plus classique à la plus créative.

Durch das Kombinieren der drei Module, ganz wie es einem gefällt, kann man sein ideales Sofa schaffen, mit unterschiedlichen Sitztiefen und Konfigurationen, die von der Klassischsten bis zu Kreativsten gehen.

Lo stile di Muffin è definito dall'elegante trapuntatura, dal taglio obliquo che unisce in un tutt'uno seduta e schienale e dai volumi morbidi ed essenziali, che rendono superfluo persino il bracciolo.

The hallmark features of Muffin's style are the elegant quilting, diagonal cut that joins the seat and back as one, and the simple, soft volumes that dispense with the need for armrests.

Le style de Muffin est défini par l'élégant matelassage, par la coupe oblique qui unit l'assise et le dossier et par les volumes doux et essentiels, qui rendent même l'accoudoir superflu.

Der Stil von Muffin ist von der eleganten Steppnaht, dem schrägen Schnitt, der Sitzfläche und Rückenlehne in einem vereint, und den weichen, essenziellen Volumen, die sogar die Armlehne überflüssig machen, geprägt.



Difficile rinunciare alla comodità di distendersi su una soffice chaise longue. Tutti gli elementi sono uniti tra loro tramite un pratico sistema di aggancio a staffe brevettato da Felis.

Give in to the temptation of the comfort of stretching out on a soft chaise longue. All the elements can be joined together using a handy catch system patented by Felis.

Difficile de résister au confort d'une méridienne moelleuse pour s'allonger. Tous les éléments sont reliés entre eux par l'intermédiaire d'un système pratique d'attache breveté par Felis.

Schwierig dem Wunsch zu widerstehen, sich gemütlich auf einer weichen Chaiselongue auszustrecken. Alle Elemente können mit einem praktischen von Felis patentierten Bügeleinhaksystem verbunden werden.



Reverso

Reverso è pura libertà. La stessa di quando, da bambini, si giocava con i mattoncini delle costruzioni. L'idea di componibilità di Reverso parte da qui: il divano diventa ogni volta una creazione unica, personale, grazie a sedute, schienali e braccioli di tante dimensioni diverse, ai bordi lisci o pizzicati, alla scelta dei tessuti e dei cuscini più adatti al proprio sentire.

Reverso is pure freedom. The freedom of a child playing with building blocks. Reverso's modular design starts here, resulting in a unique personalised sofa thanks to the different size seat cushions, back and armrests, smooth or pinched edges, choice of fabrics and cushions that adapt to suit your mood.

Reverso est la liberté pure. Cette même liberté que l'on avait lorsque, enfants, on jouait avec des blocs de construction. L'idée de modularité de Reverso part de là : le canapé devient à chaque fois une création unique et personnelle, grâce à des assises, à des dossiers et à des accoudoirs de nombreuses tailles différentes, aux bordures lisses ou surpiquées, au choix des tissus et des coussins les plus adaptés à nos sensations.

Reverso ist reine Freiheit. Dieselbe wie damals, als wir als Kinder mit Bauklötzen gespielt haben. Die Idee von der Komponierbarkeit von Reverso beginnt hier: Das Sofa ist jedes Mal eine einmalige, persönliche Kreation, durch die verschieden großen Sitzflächen, Rückenlehnen und Armlehnen mit glatten Rändern oder Pizzicato, je nach den ausgewählten Stoffen, und den Kissen, die einem am besten gefallen.





Reverso, in una delle sue infinite interpretazioni: confortevoli cuscini schiena, una seduta più profonda, braccioli di altezze diverse e il gusto sartoriale della finitura pizzicata.

Reverso in one of its infinite layouts featuring comfortable backrests, a deeper seat, different height armrests and the tailored look of pinched edges.

Reverso, dans l'une de ses interprétations infinies: des coussins de dossier confortables, une assise plus profonde, des accoudoirs de différentes hauteurs et le goût sartorial de la finition pincée.

Reverso in einer seiner unendlichen Interpretationen: bequeme Rückenissen, eine tiefe Sitzfläche, verschieden hohe Armlehnen und der Stoff im Schneiderstil mit Pizzicato-Endbearbeitung.





Ci sono molti modi di vivere il bracciolo: seduti, sdraiati, appoggiati. Reverso offre la possibilità di configurarlo come si vuole, scegliendo tra cinque profondità, due altezze e due larghezze differenti.

There are lots of ways to use the armrest: sitting up, stretched out, leaning back. Reverso lets you arrange it however you like with a choice of five depths, and two different heights and widths.

Il existe de nombreuses façons d'utiliser un accoudoir : pour s'asseoir, pour s'allonger, pour s'appuyer dessus. Reverso offre la possibilité d'être configuré à votre guise, en choisissant parmi cinq profondeurs, deux hauteurs et deux largeurs différentes.

Die Armlehne kann man sitzend, ausgestreckt, angelehnt nutzen. Reverso kann man zusammenstellen, wie es einem gefällt, indem man zwischen fünf Tiefen, zwei Höhen und zwei Breiten wählt.



Non solo terminale. Il bracciolo diventa elemento compositivo anche tra le sedute, per creare soluzioni originali, dinamiche, che infrangono la classica linearità del divano.

Not just at the end. The armrest can be used between the seats to create original, dynamic solutions that break up the classic linear look of the sofa.

Pas qu'un élément terminal. L'accoudoir devient également un élément de composition entre les assises, pour créer des solutions originales et dynamiques qui brisent la linéarité classique du canapé.

Nicht nur Endelement. Die Armlehne wird zu einem Kompositionselement auch zwischen den Sitzmöbeln, um originelle, dynamische Lösungen zu schaffen, welche die klassische Gradlinigkeit des Sofas aufbrechen.







La versione bifacciale, ideale in ambienti spaziosi, mette qui in mostra numerose combinazioni di seduta, per la quale sono possibili quattro misure di profondità e nove di larghezza.

The two-sided version, ideal for large spaces, showcases the numerous seating combinations with the choice of four depths and nine widths.

La version îlot, idéale dans les pièces spacieuses, dispose ici de nombreuses combinaisons d'assises, pour lesquelles quatre profondeurs et neuf largeurs sont disponibles.

Die zweiseitige Vision, ideal für große Räume, stellt zahlreiche Sitzkombinationen zur Schau, für die vier verschiedene Tiefen und neun verschiedene Breiten zur Auswahl möglich sind.



Liberi di arredare in un gioco di incastri, per creare situazioni di comfort diversificate. Anche lo schienale è disponibile in cinque configurazioni di larghezza, due di spessore e due di altezza.

Slot the sofa together like building blocks to create lots of different comfortable solutions. The backrest is also available in five widths, two thicknesses and two heights.

Une liberté d'ameublement dans un jeu d'emboîtements, pour créer des situations de confort diversifiées. Le dossier est lui-aussi disponible en cinq configurations de largeur, deux épaisseurs et deux hauteurs.

Die Freiheit, spielerisch Einrichtungselemente zusammenzustecken, um unterschiedliche Komfortsituationen zu schaffen. Auch die Rückenlehne ist in fünf Breitenkonfigurationen, zwei Dicken und zwei Höhen verfügbar.

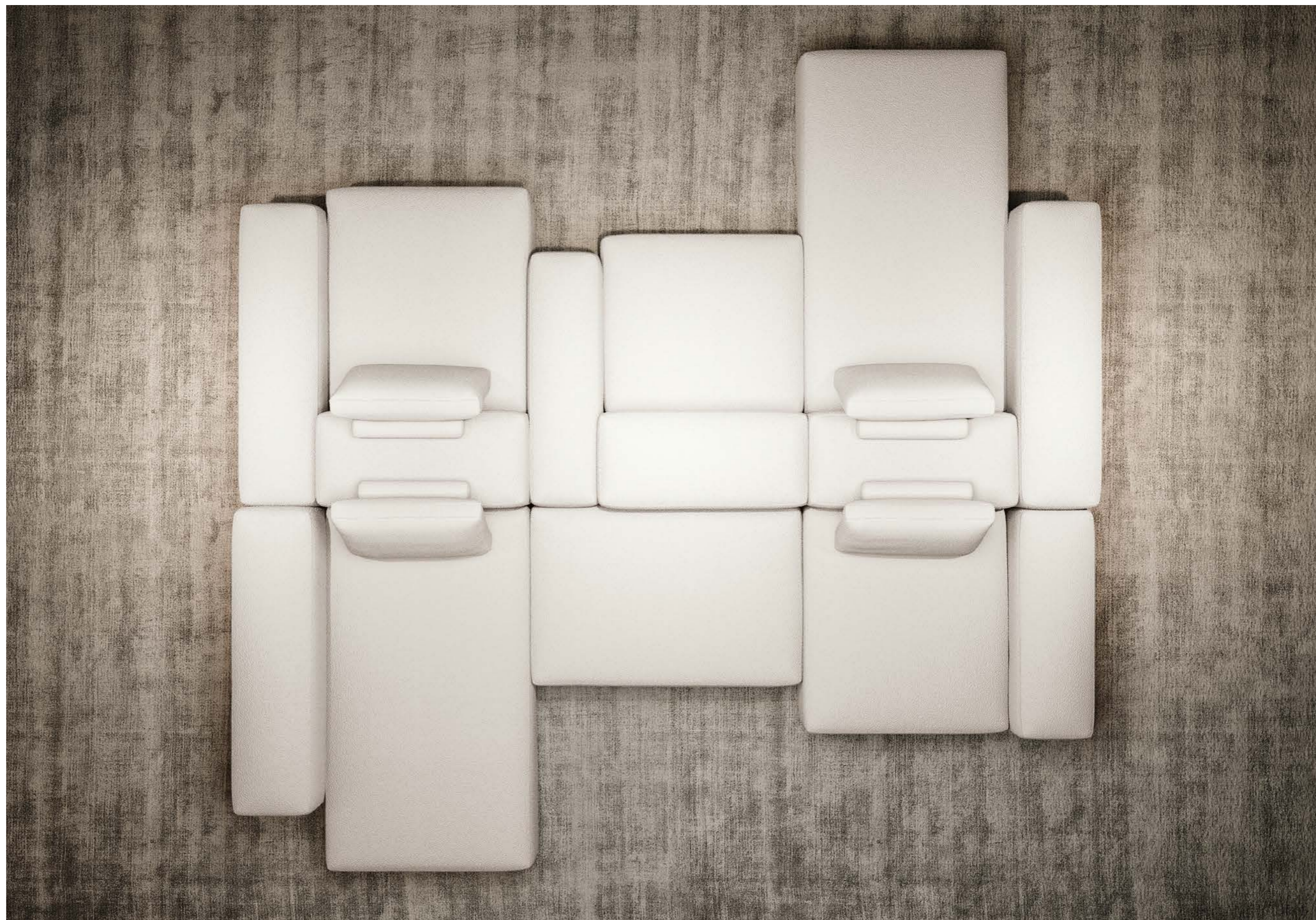

Uno sguardo ai dettagli: il cuscino a rullo è pensato per supportare perfettamente il cuscino in appoggio allo schienale.

Focus on the details: the bolster cushion is designed to provide perfect support against the backrest cushion.

Un regard sur les détails : le coussin cylindrique est conçu pour soutenir parfaitement le coussin en appui sur le dossier.

Ein Blick auf die Details: Die Kissenrollen sind perfekt, um das Stützkissen der Rückenlehnen zu tragen.



Con o senza cuscini schiena, con i contorni pizzicati o lisci a ribattitura, con moduli di dimensioni diverse o classicamente lineare: Reverso è la soluzione che accontenta tutti.

With or without backrest cushions, with pinched or seamless edges, with different size modules or classical straight lines: Reverso will keep everyone happy.

Avec ou sans coussins de dossier, avec des bordures surpiquées ou lisses, avec des modules de tailles différentes ou classiquement linéaire : Reverso est la solution qui satisfait tout le monde.

Mit oder ohne Rückenissen, mit den Rändern in Pizzicato oder glatt, mit Modulen unterschiedlicher Größe oder klassisch gradlinig: Reverso ist die Lösung, die alle zufriedenstellt.







La scelta dei cuscini permette di dare un ulteriore tocco personale di stile e comfort. Che si opti per quelli tradizionali, con volant o per un mix di entrambi, il relax è sempre garantito.

The choice of cushions adds a finishing touch of personal style and comfort. Whether you choose traditional cushions with a ruffle or a combination of the two, relaxation is guaranteed.

Le choix des coussins permet de donner une touche personnelle supplémentaire de style et de confort. Que l'on opte pour des modèles traditionnels, à volants ou un mélange des deux, la détente est toujours garantie.

Die Auswahl der Kissen erlaubt, dem Stil und dem Komfort einen letzten persönlichen Touch zu geben. Ob man nun die traditionellen Kissen nimmt oder die mit Volant oder eine Mischung aus beiden, die Entspannung garantiert ist.



Una seduta unica, con due schienali: qui Reverso utilizza uno dei suoi moduli di seduta più larghi per dare vita a una composizione senza interruzioni, perfetta anche per distendersi.

A unique seating solution with two backrests: here Reverso uses one of its wider seat modules to create an uninterrupted layout, perfect for stretching out on.

Une assise unique, avec deux dossiers : ici, Reverso utilise l'un de ses modules d'assise les plus larges pour donner vie à une composition sans interruptions, elle aussi parfaite pour se détendre.

Ein einzigartiges Sitzmöbel mit zwei Rückenlehnen: hier verwendet Reverso eines seiner breitesten Sitzmodule, um eine Komposition ohne Unterbrechungen zum Leben zu erwecken, die zum Ausstrecken einlädt.





Limitless

Sinuoso, armonioso. Limitless, con la sua forma, è un invito: a sedersi, a sdraiarsi, ad abbandonarsi. A lasciare, per un istante, il mondo fuori. Nessun limite alle combinazioni, per inseguire il gusto tutto personale di stare comodi.

Curvy, well-balanced. Limitless, with its shape, invites you to sit down, stretch out and let yourself go. To leave the world outside just for a minute. No limit to combinations, to pursue your personal idea of comfort.

Sinueux, harmonieux. Avec sa forme, Limitless est une invitation : à s'asseoir, à s'allonger, à s'abandonner. À laisser, pour un instant, le monde à l'extérieur. Aucune limite aux combinaisons, afin de satisfaire son propre goût, tout personnel, d'être à l'aise.

Geschmeidig, harmonisch. Limitless ist mit seiner Form eine Einladung: sich hinzusetzen, sich hinzulegen, sich ganz zu entspannen. Die Welt für einen Moment draußen lassen. Das ist Limitless: unbegrenzte Kombinationsmöglichkeiten, um dem ganz persönlichen Geschmack des Wohlbefindens nachzugehen.







La purezza del design essenziale e raffinato. La possibilità di aggiungere la soffice comodità dei cuscini schienale. A ognuno la sua scelta, per coniugare in modo personale stile e comfort.

The pure lines of the understated and elegant design. The option of adding the comfort of soft backrest cushions. The freedom to choose your own combination of style and comfort.

La pureté du design essentiel et raffiné. La possibilité d'ajouter le confort moelleux des coussins de dossier. À chacun son choix, pour conjuguer de manière personnelle style et confort.

Die Reinheit des wesentlichen und raffinierten Designs. Die Möglichkeit, den weichen Komfort der Rückenissen hinzuzufügen. Jedem seine Wahl, Stil und Komfort auf persönliche Weise zu kombinieren.









Una linea corre lungo i profili di schienale e braccioli: è la raffinata fettuccia che, nel cucire tra loro i tessuti delle fodere, gioca a contrasto per impreziosire le forme del divano.

A line runs along the profiles of the backrest and armrests: it is the refined ribbon which, in sewing the fabrics of the covers together, plays with contrast to embellish the shapes of the sofa.

Une ligne court le long des profils du dossier et des accoudoirs : c'est le cordon raffiné qui joue le contraste avec les tissus du revêtement pour embellir la forme du canapé.

Eine Linie verläuft entlang der Konturen der Rückenlehne und der Armlehnen: Es ist das raffinierte Band, das beim Zusammennähen der Bezugsstoffe im Kontrast dazu die Formen des Sofas verschönert.



Leggero, quasi sospeso nell'aria. Limitless è un equilibrio armonioso tra le morbide e importanti sedute, che ne definiscono lo sviluppo orizzontale, e gli esili piedini che si rivelano alla vista.

Léger, presque suspendu dans l'air. Limitless est un équilibre harmonieux entre les assises souples et imposantes qui définissent son développement horizontal et les pieds élancés qui se révèlent au regard.

Light, almost suspended in the air. Limitless is a harmonious balance between its soft and big seats, which define its horizontal development, and its slender feet that peek out.

Leicht, fast schwebend in der Luft. Limitless ist ein harmonisches Gleichgewicht zwischen den weichen, markanten Sitzflächen, die seine horizontale Entwicklung bestimmen, und den schlanken Füße, die sich dem Auge offenbaren.



Soffici braccioli, sedute accoglienti e design ricercato: Limitless soddisfa ogni esigenza del vivere contemporaneo ed è il protagonista perfetto anche al centro del living.

Soft armrests, welcoming seats and refined design: Limitless satisfies every need of contemporary living and is the perfect protagonist even in the centre of the living room.

Accoudoirs souples, assises confortables et design sophistiqué: Limitless répond à tous les besoins de la vie contemporaine et est également le protagoniste parfait au centre du salon.

Weiche Armlehnen, gemütliches Sitzen und raffiniertes Design: Limitless erfüllt alle Anforderungen an zeitgemäßes Wohnen und ist der perfekte Protagonist auch in der Mitte des Wohnzimmer.





Limitless invita a pensare in grande al relax quotidiano. La composizione con doppia chaise longue aumenta la profondità di seduta, e con essa il piacere di distendersi in tutta comodità.

Limitless invites you to think big about daily relax. The composition with double chaise longue increases the depth of the seat, and therefore the pleasure of relaxing in complete comfort.

Limitless vous invite à voir grand en matière de détente quotidienne. La composition avec double chaise longue augmente la profondeur d'assise, et donc le plaisir de s'allonger confortablement.

Limitless lädt Sie dazu ein, die tägliche Entspannung groß zu denken. Die Komposition mit doppelter Chaiselongue vergrößert die Sitztiefe und damit auch das Vergnügen, bequem zu liegen.





Essenziale, per dare risalto alle sue linee pulite, o con l'aggiunta di cuscino schienale, per un tocco di comfort in più: Limitless è come lo vuoi tu. Anche con optional poggiatesta, per un maggiore sostegno cervicale.

Essential, to emphasise its clean lines, or with the addition of a back cushion, for an extra touch of comfort: Limitless is how you want it. Also with optional headrest, for greater neck support.

Essentiel, pour souligner ses lignes épurées, ou avec l'ajout d'un coussin de dossier, pour une touche de confort supplémentaire : Limitless est à votre image. Également avec un appui-tête en option, pour un soutien supplémentaire de la nuque.

Unverzichtbar, um die klaren Linien zu betonen, oder mit einem zusätzlichen Rückenkissen, das für zusätzlichen Komfort sorgt: Limitless ist so, wie Sie es wünschen. Auch mit optionaler Kopfstütze, für zusätzliche Nackenstütze.



Grazie al sistema con pianale, i moduli possono essere gestiti in piena libertà per dare vita al divano dei propri sogni. Un rifugio di morbido comfort nei diversi momenti di lettura, svago, relax e riposo.

Thanks to its platform system, the modules can be arranged freely to create the sofa of your dreams. A refuge of soft comfort in your moments of reading, recreation, leisure and rest.

Grâce au système avec plateau, les modules peuvent être gérés librement pour créer le canapé de ses rêves. Une pause confortable et moelleuse pour un moment de lecture, de loisir, de détente et de repos.

Dank des Plattformsystems können die Module frei verwaltet werden, um das Sofa Ihrer Träume zu kreieren. Est ist ein Zufluchtsort des weichen Komforts in verschiedenen Momenten des Lesens, der Freizeit, der Entspannung und der Ruhe.

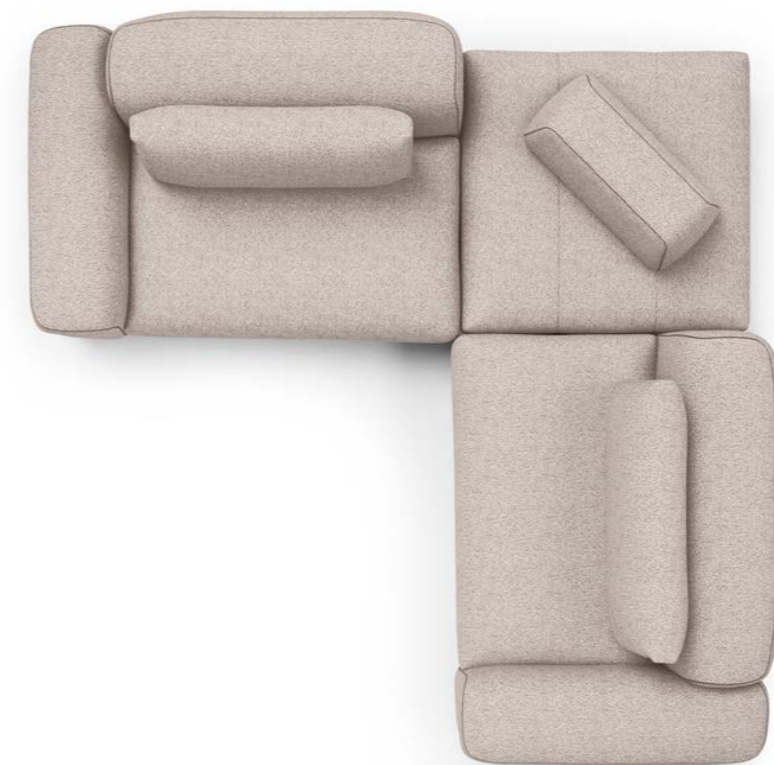

Pantheon

Divinamente comodo. Esteticamente intrigante, con linee ricamate che si rincorrono come colonne di un tempio. Pantheon apre così le porte a un maestoso relax.

Divinely comfortable. Aesthetically intriguing, with embroidered lines chasing each other like the columns of a temple. In this way, Pantheon opens the doors to a majestic relax.

Divinement confortable. Esthétiquement fascinant, avec des lignes brodées qui se poursuivent comme les colonnes d'un temple. Pantheon vous ouvre ainsi les portes d'une détente majestueuse d'un moment de détente majestueux.

Himmlisch bequem. Ästhetisch faszinierend, mit gestickten Linien, die sich wie Säulen eines Tempels aneinanderreihen. So öffnet Pantheon die Tür zu einer majestätischen Entspannung.











Una delle diverse interpretazioni di Pantheon: la versione a pozzetto, chiusa ai lati, offre una composizione classica e molto elegante, perfetta per qualsiasi contesto.

One of the many versions of Pantheon: the 'well' version, closed on the sides, creates a classic, ultra-elegant layout, perfect for any setting.

L'une des différentes interprétations de Pantheon : la version cockpit, fermée sur les côtés, offre une composition classique et très élégante, parfaite pour tous les contextes.

Eine der verschiedenen Interpretationen von Pantheon: die "Cockpitversion", die an den Seiten geschlossen ist, bietet eine klassische und sehr elegante Komposition, perfekt für jeden Kontext.









Chi opta per la composizione senza braccioli in chiusura sceglie un modo alternativo di vivere il divano, senza vincoli, per stendersi comodamente a tutta lunghezza.

An open-ended version with no armrests means choosing an alternative unconstrained way to experience the sofa - somewhere you can stretch out in total comfort.

Ceux qui optent pour la composition sans accoudoirs de fermeture choisissent une manière alternative de vivre le canapé, sans contraintes, pour s'allonger confortablement sur toute la longueur.

Wer sich für die Komposition ohne Armlehnen am Endstück entscheidet, wählt eine alternative Art und Weise, das Sofa ohne Einschränkungen zu erleben, um sich bequem in voller Länge auszustrecken.



Il pouf quadrato o rettangolare aggiunge un tocco irrinunciabile di comfort creativo alla zona living, completando così la composizione angolare.

Add a square or rectangular pouf for some all-important creative comfort in the living room - the perfect finishing touch to the corner layout.

Le pouf carré ou rectangulaire ajoute une touche essentielle de confort créatif à l'espace salon, complétant ainsi la composition d'angle.

Das quadratische oder rechteckige Sitzkissen verleiht dem Wohnbereich einen unverzichtbaren Hauch von kreativem Komfort und vervollständigt die Eckkomposition.





Pensato per essere comodo in qualsiasi modo ci sediamo, distendiamo o sdraiamo: Pantheon è il migliore alleato per il meritato comfort quotidiano.

Designed to be comfortable no matter how we sit or lay: Pantheon is the best partner for the well-deserved daily comfort.

Destiné à être confortable quelle que soit la manière dont nous nous asseyons, nous nous détendons ou nous nous allongeons : Pantheon est le meilleur allié pour un confort quotidien mérité.

Entwickelt, um bequem zu sein, egal wie wir sitzen oder legen: Pantheon ist der beste Verbündete für den wohlverdiente Alltagskomfort.

La forma del morbido bracciolo, leggermente inclinata verso l'interno, è studiata per accogliere in modo confortevole la schiena, fungendo da schienale aggiuntivo.

The shape of the slightly inward sloping soft armrest is designed to comfortably support the back and act as an extra backrest.

La forme douce de l'accoudoir souple, légèrement incliné vers l'intérieur, est étudiée pour accueillir confortablement le dos, faisant ainsi office de dossier supplémentaire.

Die Form der weichen, leicht nach innen geneigten Armlehne ist so konzipiert, dass sie den Rücken bequem umschließt und als zusätzliche Rückenlehne dient.



Chaise longue, angolari, laterali aperti: giocando con i vari elementi disponibili, Pantheon assume la forma più congeniale alle proprie esigenze di arredamento e di relax.

Chaise longue, corner modules, open sides: by playing with the various modules available, Pantheon assumes the best layout to fit in with your furnishing and relaxation needs.

Méridienne, modules d'angle, côtés ouverts : en jouant avec les différents éléments disponibles, Pantheon prend la forme la plus adaptée à vos besoins d'aménagement et de détente.

Chaiselongue, Eckelemente, offene Seiten: Durch das Spiel mit den verschiedenen Elementen nimmt Pantheon die Form an, die am besten zu Ihren Einrichtungs- und Entspannungsbedürfnissen passt.



Il ricamo, presente sia sul fronte che sul retro, nasce da un'accurata lavorazione che impreziosisce e dona movimento al divano, equilibrando il suo sviluppo spiccatamente orizzontale.

The embroidery, both on the front and back, are created by elegant stitching for added interest and movement, balancing the statement horizontal layout.

La broderie, présente aussi bien sur le devant qu'au dos, est le fruit d'un travail soigné qui embellit et donne du mouvement au canapé, équilibrant son développement nettement horizontal.

Die Stickerei, die sich sowohl auf der Vorder- als auch auf der Rückseite befindet, ist das Ergebnis einer sorgfältigen Verarbeitung, die das Sofa veredelt und ihm Bewegung verleiht, indem sie seine deutlich horizontale Entwicklung ausgleicht.



Conrad

La semplicità è la massima raffinatezza, diceva Leonardo da Vinci. In questa frase c'è tutta l'essenza di Conrad, un divano nato per sedurre con le sue linee morbide, minimali, e la cura dedicata alle cuciture e a ogni piccolo dettaglio. Disponibile in due varianti di piedino, Conrad offre un'esperienza avvolgente grazie alla profonda seduta e ai confortevoli schienali.

Simplicity is the height of sophistication according to Leonardo da Vinci. This phrase sums up the essence of Conrad, a sofa born to seduce with its soft, minimal lines and meticulous seams and attention to detail. Available with two different types of feet, Conrad offers the ultimate relaxation with its deep seats and comfortable backrests.

La simplicité est la sophistication suprême, disait Léonard de Vinci. Dans cette phrase, se trouve toute l'essence de Conrad, un canapé né pour séduire avec ses lignes douces, minimalistes, et le soin accordé aux coutures et à chaque petit détail. Disponible en deux variantes de pieds, Conrad offre une expérience enveloppante grâce à l'assise profonde et aux dossiers confortables.

Die Einfachheit ist die höchste Raffiniertheit, sagte Leonardo da Vinci. In diesem Satz steckt das ganze Wesen von Conrad, einem Sofa, das mit seinen weichen, minimalistischen Linien und der Sorgfalt, die für die Nähte und jedes kleine Details verwendet wurde, zum Verführen geboren ist. Erhältlich mit zwei Fußvarianten lädt Conrad dank der tiefen Sitzfläche und den gemütlichen Rückenlehnen zum Hineinkuscheln ein.



Caratteristica del design di Conrad è la bombatura del bracciolo che abbraccia la seduta, inglobandola in un'armoniosa composizione.

The hallmark feature of Conrad is the rounded shape of the armrest that encircles the seat to create a balanced layout.

La caractéristique du design de Conrad est l'accoudoir bombé qui embrasse l'assise, l'incorporant dans une composition harmonieuse.

Charakteristisch für das Conrad-Design ist die Wölbung der Armlehne, die die Sitzfläche umspannt und in eine harmonische Komposition einverleibt.







Come per tutti i modelli Felis, anche i rivestimenti di Conrad sono completamente sfoderabili e disponibili in oltre 500 varianti di tessuto tra cui scegliere.

As with all the Felis models, Conrad's covers are all fully removable and available in a choice of over 500 fabric variations.

Comme pour tous les modèles Felis, revêtements de Conrad sont eux aussi entièrement déhoussables et disponibles dans plus de 500 variantes de tissus parmi lesquelles choisir.

Wie für alle Modelle Felis sind, auch die Bezüge von Conrad komplett abziehbar und erhältlich in über 500 verschiedenen Stoffen sind, unter denen man auswählen kann.

In questa pagina e in quella a fianco, Conrad si presenta con chaise longue integrata, nelle due varianti con piedino a barra e a stiletto.

On this page and the one to the side, Conrad is showcased with the integrated chaise longue in two versions featuring a bar and stiletto foot.

Sur cette page et la page ci-contre, Conrad est présenté avec une méridienne intégrée, dans les deux variantes avec pieds à barre et aiguille.

Auf dieser Seite und der Seite daneben ist Conrad mit integrierter Chaiselongue in den beiden Varianten mit Stangenfuß und Stilett-Fuß zu sehen.







Le due interpretazioni di Conrad: qui, la barra in metallo in finitura grigio antracite enfatizza la sensazione visiva di stabilità della struttura.

Two interpretations of Conrad: here, the metal bar with an anthracite grey finish underscores the visual stability.

Les deux interprétations de Conrad : ici, la barre métallique finition gris anthracite souligne la sensation visuelle de stabilité de la structure.

Die zwei Interpretationen von Conrad: Hier betont die in anthrazitgrau lackierte Metallstange das visuelle Gefühl von der Stabilität des Gestells.



Il piedino a stiletto dona invece maggiore leggerezza al divano. È presente anche nella variante con rondella, per una totale sicurezza sul parquet.

The stiletto foot increases the sense of lightness. There is also a version with round pads to protect parquet floors.

Le pied aiguille donne quant à lui une plus grande légèreté au canapé. Il existe également dans la variante avec rondelle, pour une sécurité totale sur le parquet.

Der Stilet-Fuß gibt dem Sofa einen Anschein von Leichtigkeit. Es gibt das Sofa auch in der Variante mit Unterlegscheibe für eine absolute Sicherheit auf dem Parkett.



In una soluzione a L, l'elemento angolare può essere lasciato libero, per sfruttare appieno l'ampia superficie, o completato con il cuscino a cricchetto Ritual, per il massimo agio.

In an L-shaped solution, the corner element can be left free to make the most of the wide surface area or completed with the adjustable Ritual cushion for maximum comfort.

Dans une solution en L, l'élément d'angle peut être laissé libre, pour profiter pleinement de la grande surface, ou être complété par le coussin inclinable Ritual, pour un confort maximal.

Das Winkelement in L-Form kann frei gelassen werden, um die breite Oberfläche voll auszunutzen, oder mit dem Kissen mit Ratsche Ritual für den höchsten Komfort vervollständigt werden.



L'aggiunta di un modulo terminale aumenta esponenzialmente il comfort grazie alla profonda seduta e al doppio cuscino di rinforzo appoggiato al bracciolo.

An end element adds extra comfort thanks to the deep seat and double reinforcement cushion placed against the armrest.

L'ajout d'un module terminal augmente de façon exponentielle le confort grâce à l'assise profonde et au double coussin de renfort posé sur l'accoudoir.

Wird ein Endmodul hinzugefügt, erhöht sich der Komfort exponentiell dank der tiefen Sitzfläche und dem doppelten Stützkissen auf der Armlehne.



Capitol

Eleganza e qualità senza tempo. Capitol rappresenta l'archetipo stesso del divano, con le sue forme pulite e l'estremo comfort della seduta e dello schienale. Un ritorno a una raffinata semplicità, che non rinuncia però al guizzo di soluzioni inaspettate. Come la possibilità di creare vere e proprie isole di benessere domestico giocando con gli elementi terminali e angolari.

Timeless elegance and quality. Capitol represents the essence of the sofa with its clean lines and ultra-comfortable seat and backrest. A return to simple values but still with an unexpected range of solutions. Like the possibility of creating islands of domestic bliss by playing with the end and corner elements.

Élégance et qualité intemporelles. Capitol représente l'archétype même du canapé, avec ses formes épurées et le confort extrême de l'assise et du dossier. Un retour à la valeur de la simplicité, qui ne renonce cependant pas à la découverte de solutions inattendues. Comme la possibilité de créer de véritables îlots de bien-être domestique en jouant avec les éléments terminaux et d'angle.

Zeitlose Eleganz und Qualität. Capitol repräsentiert den Archetyp des Sofas, mit seinen reinen Formen und dem extremen Komfort der Sitzfläche und der Rückenlehne. Die Wiederentdeckung des Werts der Schlichtheit, in der unerwartete Lösungen aufflackern. Wie die Möglichkeit, mit den End- und Eckelementen echte Inseln des häuslichen Wohlgefühls zu bauen.





Le linee inclinate che caratterizzano l'interno del bracciolo dialogano con quelle del piedino, donando una forte impronta di stile al design di Capitol.

The sloped lines featured on the inside of the armrest mirror those of the feet, to create Capitol's statement look of style and design.

Les lignes inclinées qui caractérisent l'intérieur de l'accoudoir interagissent avec celles du pied, donnant une forte empreinte de style au design de Capitol.

Die charakteristischen geneigten Linien innen an den Armlehnen stehen im Dialog mit denen des Fußes, der dem Design eine starke Stilausprägung verleiht.





Capitol consente diverse possibilità di configurazione, utilizzando per esempio moduli chaise longue (immagine sopra), terminale (sotto) o angolari (a fianco).

Capitol provides you with different layout options using the chaise longue modules for example (image above), end elements (below) or corner elements (side).

Capitol offre plusieurs possibilités de configuration, en utilisant par exemple des modules de méridienne (image ci-dessus), terminaux (ci-dessous) ou d'angle (ci-contre).

Capitol erlaubt, mit den Chaiselongue-Modulen (Bild oben), Endmodulen (unten) oder Winkelmodulen (an der Seite) verschiedene Konfigurationen zusammenzustellen.





Quando serve uno schienale in appoggio, il cuscino Ritual è la soluzione perfetta. Dotato di cricchetto regolabile in differenti inclinazioni, può essere spostato liberamente in base alle esigenze.

Ritual is the perfect solution when you need a backrest. Equipped with an adjustable mechanism, this cushion can be moved freely according to the needs.

Lorsqu'un dossier en appui est nécessaire, le coussin Ritual est la solution parfaite. Doté d'une charnière réglable avec plusieurs inclinaisons, il peut être orienté librement en fonction des besoins.

Wenn Sie eine Stütze im Rücken brauchen, ist das Kissen Ritual die perfekte Lösung. Mit der verstellbaren Ratsche kann die Rückenlehne frei nach Belieben gekippt werden.





Da una composizione all'altra, è solo questione di punti di vista. Ruotando i due terminali fino a far incontrare i braccioli, si crea infatti un'isola profonda e accogliente.

Change your point of view from one layout to another. Turn the end elements to bring the armrests together and create a deep, ultra-comfortable island.

D'une composition à l'autre, ce n'est qu'une question de point de vue. En tournant les deux éléments terminaux jusqu'à la rencontre des accoudoirs, il est possible de créer un îlot profond et accueillant.

Von einer Komposition zur nächsten ist es nur eine Frage des Blickpunkts. Dreht man die beiden Endelemente bis zu den Armlehnen, entsteht eine tiefe und gemütliche Insel.





Float

Design:
Massimo Iosa Ghini

Float è il morbido realizzarsi di un'ispirazione. Assenza di forma che si fa comfort estremo, alla vista prima ancora che nell'uso. Abbondanza di materiale che accoglie in un dolce invito a sedersi.

Float is the soft fulfilment of an inspiration. Absence of shape becomes extreme comfort, to the eye even before use. An abundance of material that welcomes you with a gentle invitation to take a seat.

Float est la réalisation douce d'une inspiration. Absence de forme qui devient confort extrême, à regarder avant même de l'utiliser. Abondance de matériel qui vous accueille en une invitation douce à s'asseoir.

Float ist die weiche Verwirklichung einer Inspiration. Eine nicht vorhandene Form, die zu extremem Komfort wird, beim Anblick noch vor dem Gebrauch. Üppig verwendetes Material, das eine sanfte Einladung zum Sitzen darstellt.











Il disegno del divano, qui nella versione lineare, nasce da un segno architettonico molto semplice: la curva, forma naturale, capace di aprire un dialogo tra leggerezza, morbidezza e volumi.

The design of the sofa, here in the linear version, stems from a very simple architectural form: the curve, a natural shape able to open a dialogue between lightness, softness and volumes.

Le dessin du canapé, qui dans la version linéaire, naît d'un signe architectonique très simple : la courbe, forme naturelle, capable d'ouvrir un dialogue entre légèreté, souplesse et volumes.

Das Design des Sofas, hier in der linearen Version, geht von einem sehr einfachen baulichen Merkmal aus: der Kurve, einer natürlichen Form, die einen Dialog zwischen Leichtigkeit, Weichheit und Volumen eröffnet.







La collezione Float svela sé stessa nella fluidità, così contemporanea, delle sue linee. E in quel raffinato mettersi in mostra delle pieghe, gioco stilistico che richiama in un andirivieni il movimento delle onde.

The Float collection manifests itself in the fluidity of its contemporary lines. And in the refined showcasing of the pleats, a play on style that evokes in its movement back and forth, the motion of the waves.

La collection Float se dévoile dans la fluidité, ainsi que contemporanéité, de ses lignes. Et dans la capacité raffinée de mettre en avant ses plis, jeu de style qui rappelle un va-et-vient du mouvement des vagues.

Die Kollektion Float besticht durch eine fließende, zeitgemäße Linienführung. Und durch eine raffinierte Darstellung der Falten, ein stilistisches Spiel, das an die Bewegung der Wellen in einem Kommen und Gehen erinnert.



Gravity

L'idea di un relax sospeso nel tempo e nell'aria. Gravity è il divano componibile dotato di diversi moduli e di schienali zavorrati mobili per creare sempre nuove configurazioni. Pensato con i piedini in vetro, ma disponibile anche nella variante in metallo.

The idea of relaxation suspended in time and in the air. Gravity is a sectional sofa featuring various modules and movable weighted backrests to create ever new arrangements. Designed with glass feet but also available with metal version.

L'idée d'un relax suspendu dans le temps et dans l'air. Gravity est le canapé modulaire doté de différents modules et de dossiers lestés mobiles afin de créer toujours de nouvelles configurations. Idéalisé avec des petits pieds en verre, mais également disponible avec la variante en métal.

Die Vorstellung von Entspannung, die in der Zeit und in der Luft schwebt. Gravity ist das modulare Sofa aus mehreren Modulen mit beweglichen, ballastierten Rückenlehnen, die neue Konfigurationen ermöglichen. Mit Glasfüßen ausgestattet, aber auch mit Metallfüßen erhältlich.

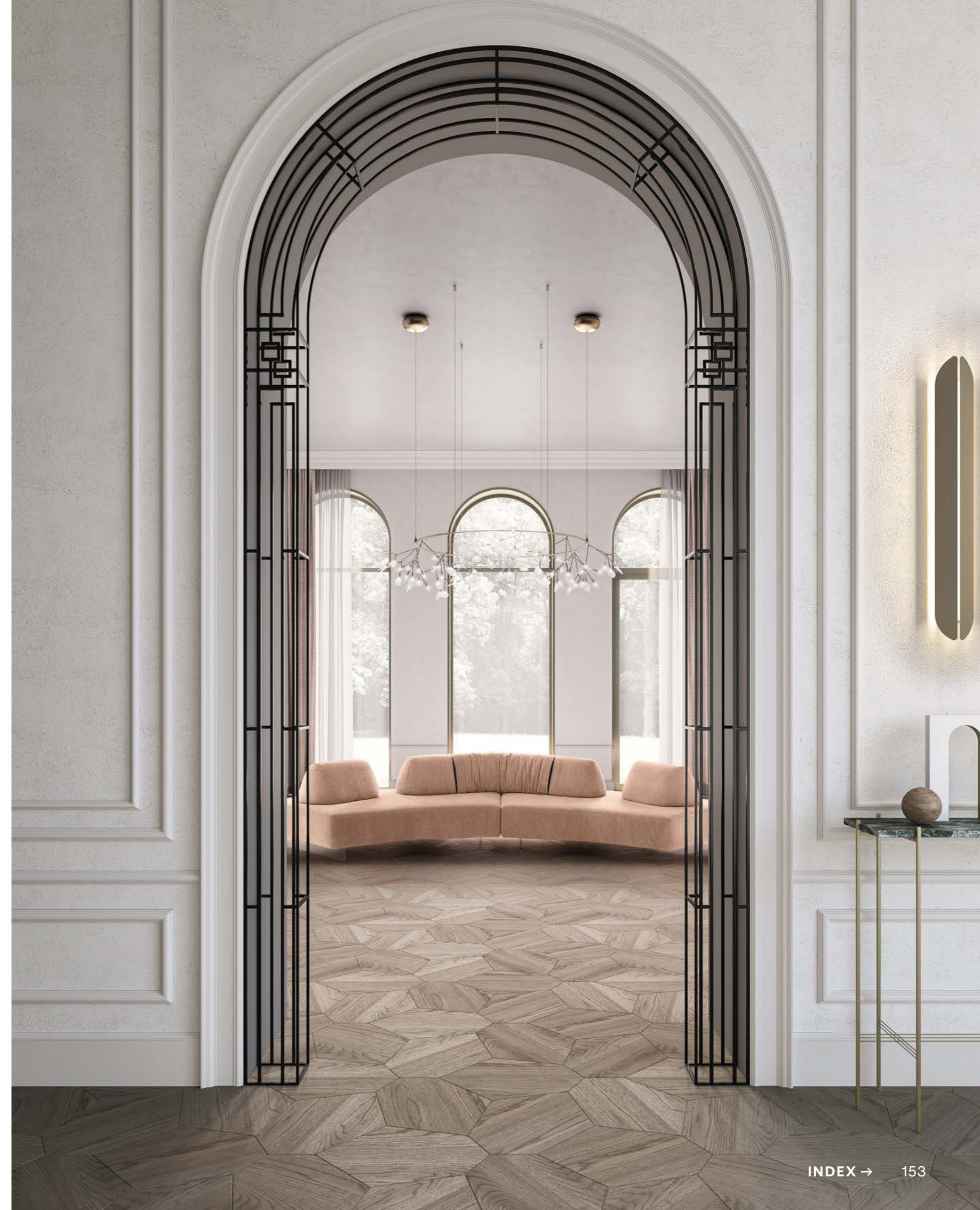





Il programma Gravity offre grande libertà compositiva grazie a moduli di forme e dimensioni differenti combinabili tra loro.

The Gravity program offers great freedom in terms of arrangement, as sections are available in different shapes and sizes and can be mixed and matched.

Le programme Gravity offre une grande liberté de compositions grâce aux modules de formes et dimensions différentes combinables entre eux.

Das Programm Gravity bietet eine große Gestaltungsfreiheit, da die Module in verschiedenen Formen und Größen miteinander kombiniert werden können.



Seduti o sdraiati, il comfort su Gravity non ha limiti: il cuscino Snake assume la forma che preferisci in ogni situazione.

Whether seated or lying down, comfort on Gravity has no limits: the Snake cushion takes on your preferred shape, adapting to any situation.

Assis ou allongés, le confort sur Gravity n'a aucune limite : le coussin Snake prend la forme que vous préférez dans quelque situation.

Ob im Sitzen oder im Liegen, dem Komfort auf Gravity sind keine Grenzen gesetzt: Das Kissen Snake nimmt in jeder Situation die von Ihnen bevorzugte Form an.







Un'aggiunta di comfort: con il cuscino schienale dalla morbida bombatura è ancora più rilassante abbandonarsi alla lettura di un libro o alla propria serie tv preferita.

Added comfort: the smooth dome-shaped cushion makes indulging in reading a book or watching your favorite TV series even more relaxing.

Un confort supplémentaire: avec le coussin dossier au bombage souple c'est encore plus relaxant de s'abandonner à la lecture d'un livre ou à la propre série Télé préférée.

Zusätzlicher Komfort: Mit dem sanft geschwungenen Rückenissen ist es noch entspannender, ein Buch zu lesen oder seine Lieblingsserie zu schauen.





Platform

Immagina un sistema modulare che cambia, come cambiano le esigenze di benessere. È Platform, il programma di basi combinabili dalle linee minimal-chic: tante soluzioni di configurazione e la possibilità di posizionare i cuscini e gli schienali a piacere per un comfort su misura.

Imagine a modular system that changes as your comfort requirements change. Platform is a program of mix-and-match bases sporting minimal-chic style offering plenty of arrangement solutions and the opportunity to position the cushion as you like for tailor-made comfort.

Imaginez un système modulaire qui change, comme changent les exigences de bien-être. C'est Platform, le programme de bases modulables aux lignes minimalistes chic : autant de solutions de configuration et la possibilité de positionner les coussins et les dossiers au plaisir pour un confort sur mesure.

Stellen Sie sich ein modulares System vor, das sich an die sich ändernden Anforderungen an Ihr Wohlbefinden anpasst. Es handelt sich um Platform, das kombinierbare Unterschrankprogramm mit minimalistischen Linien: viele Konfigurationslösungen und die Möglichkeit, Kissen und Rückenlehnen nach Belieben zu positionieren, für maßgeschneiderten Komfort.









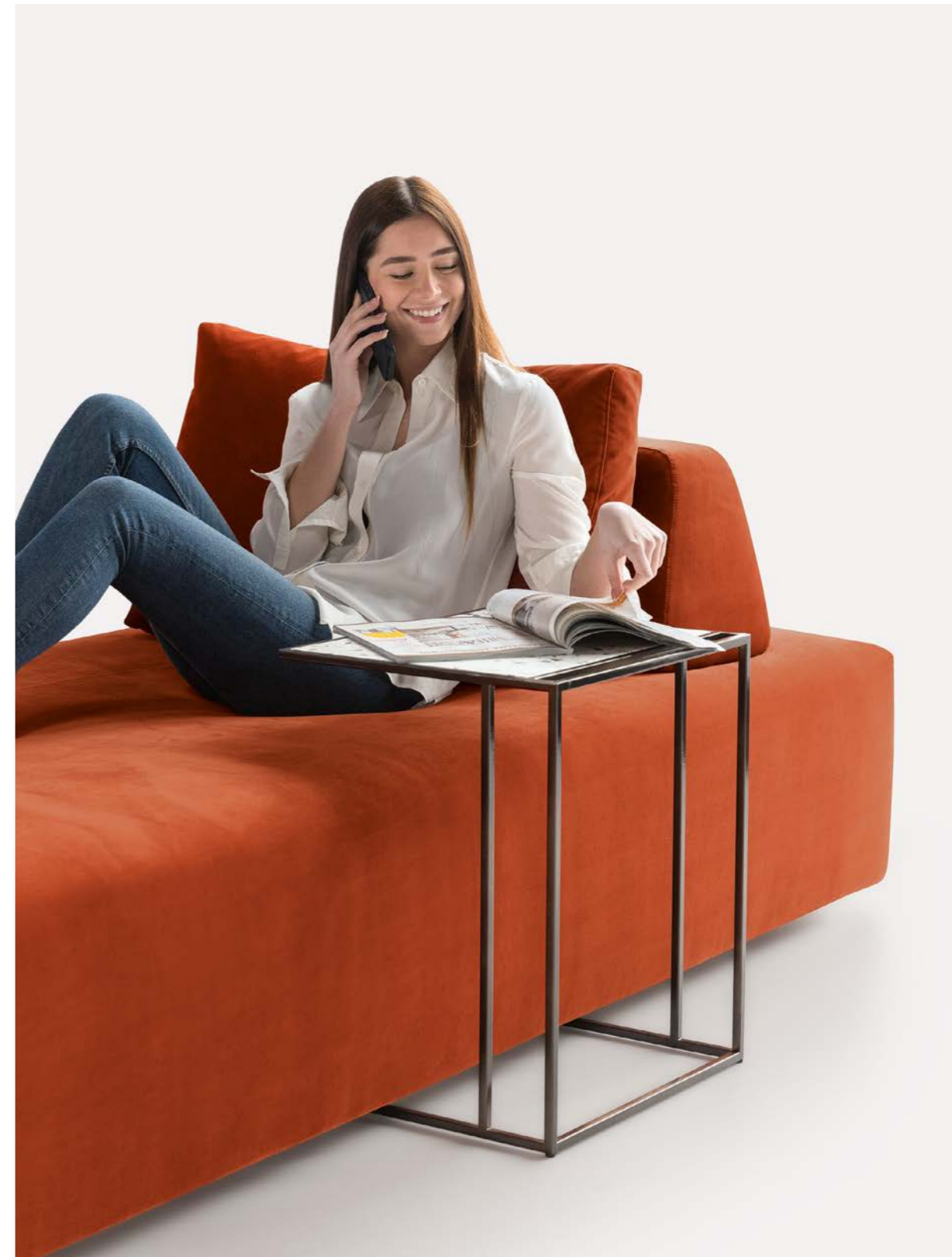

Gli schienali trapezoidali possono essere spostati in qualsiasi posizione per assecondare richieste di comfort sempre diverse.

The trapezoidal backrests can be moved to any position to accommodate your ever-changing comfort requirements.

Les dossiers trapézoïdaux peuvent être déplacés en quelque position afin de satisfaire les exigences de confort toujours différentes.

Die trapezförmigen Rückenlehnen können in jede beliebige Position verstellt werden, um den sich ständig ändernden Komfortbedürfnissen gerecht zu werden.



**Schienali, cuscini,
braccioli: combinazioni
in continua evoluzione
per sostenere la
propria personale ricerca
di comfort.**

Rückenlehnen, Kissen,
Armlehnen: immer wieder
neue Kombinationen, um
die persönliche Suche
nach Komfort zu erfüllen.

Backrests, cushions,
armrests: continuously
evolving combinations
to indulge your very own
personal search
for comfort.

Dossiers, coussins,
accoudoirs : combinaisons
continuellement en
évolution afin de satisfaire
la propre recherche
personnelle de confort.







Il cuscino schienale con risvolto ad altezza testa va in appoggio dei cuscini zavorrati per un'esperienza di relax completa.

The backrest cushion with flap at head height provides supports for the weighted cushions for a complete relaxation experience.

Le coussin dossier avec revers à hauteur de la tête va en appui des coussins lestés pour avoir une expérience de relax complète.

Das Rückenlehnenkissen mit Kopfstützklappe stützt die ballastierten Kissen für ein absolutes Entspannungserlebnis.



Diverse interpretazioni di Platform: bracciolo e tavolino si possono inserire sia a chiusura che come collegamento tra i moduli.

Different interpretations of Platform: armrests and coffee table can be inserted at the ends or as a link between sections.

Différentes interprétations de Platform: accoudoir et petite table peuvent s'intégrer que ce soit en position terminale qu'en connexion entre modules.

Verschiedene Interpretationen von Platform: Armlehne und Couchtisch können entweder als Abschluss oder als Verbindung zwischen Modulen benutzt werden.



Larson

Il cuore di Larson batte sotto un design sofisticato. È nell'alto contenuto qualitativo della struttura, nelle soluzioni tecnologiche e, insieme, nell'artigianalità vera delle lavorazioni. Il risultato è un divano di alto livello, bello da vivere, comodo e resistente nel tempo.

Sophisticated design conceals Larson's true essence: high quality content in the frame and technological solutions combined with genuine craftsmen's workmanship. The result is a high-end sofa that is beautiful to live with, comfortable and long-lasting over time.

Le cœur de Larson bat sous un design sophistiqué. Avec un haut contenu qualitatif de la structure, dans les solutions technologiques et, ensemble, dans la vraie artisanalité de la fabrication. Le résultat : un canapé de haut niveau, beau à vivre, confortable et résistant dans le temps.

Das Herz von Larson schlägt unter einem eleganten Design. Es geht um die hohe Qualität der Struktur, die technologischen Lösungen und gleichzeitig um die handwerkliche Qualität der Verarbeitung. Das Ergebnis ist ein hochwertiges Sofa, wunderschön anzusehen, komfortabel und langlebig.















Larson seduce con la qualità e l'impeccabile vestibilità dei tessuti, l'eleganza delle linee e la ricchezza di dettagli unici, come il basamento con verniciatura esclusiva Felis e terminale godronato.

Larson seduces you with its quality and the impeccable fit of its fabrics, the elegance of its designs and its wealth of unique details, such as the painted base exclusive to Felis.

Larson séduit par sa qualité et l'ajustement impeccable de ses tissus, ses lignes élégantes et la richesse de ses détails uniques, tels que le socle verni exclusivité Felis.

Larson besticht durch die Qualität und die tadellose Passform der Stoffe, die eleganten Linien und die zahlreichen einzigartigen Details, wie z. B. der Sockel mit der exklusiven Lackierung Felis.



All-in

Linee eleganti, generosi braccioli, schienale basso che sostiene e accoglie ogni posizione di relax grazie ai poggiatesta regolabili. Sedute e chaise longue estraibili in tre scatti per distendere le gambe. All-in è tutto il meglio del comfort su misura.

Elegant lines, generous armrests and a low backrest, which provides support and, thanks to the adjustable headrests, accommodates all relaxation positions. Seats and chaise longue extend into three positions to allow the legs to be fully distended. All-in is tailor-made comfort at its best.

Lignes élégantes, accoudoirs généreux, dossier bas qui soutient et accueille quelque position de relax grâce aux appui-têtes réglables. Assises et chaise longue extractibles en trois clics pour allonger les jambes. All-In est le tout meilleur du confort sur mesure.

Elegante Linien, großzügige Armlehnen, eine niedrige Rückenlehne, die dank der verstellbaren Kopfstützen jede Entspannungsposition unterstützt und zulässt. Die Sitze und die Chaiselongue lassen sich in drei Schritten ausziehen, um sich die Beine zu vertreten. All-in ist das Beste, was es an maßgeschneidertem Komfort gibt.







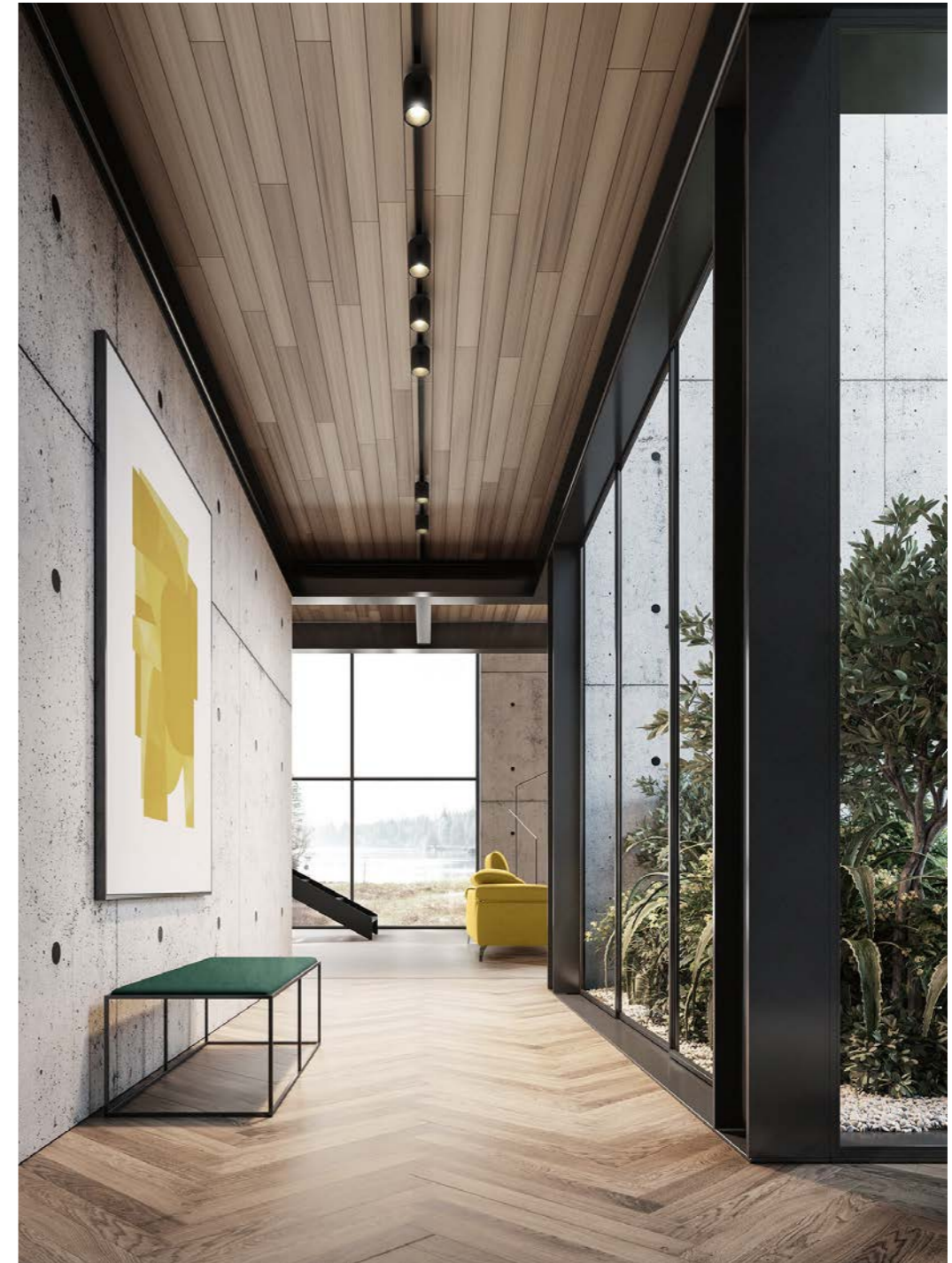







CHAISE LONGUE CON MECCANISMO A SCIVOLAMENTO.
CHAISE LONGUE WITH SLIDING MECHANISM.
CHAISE LONGUE AVEC MÉCANISME À GLISSEMENT.
CHAISELONGUE MIT SCHIEBEMECHANISMUS.

Anche la chaise longue è disponibile con meccanismo a scivolamento in tre posizioni per ogni situazione di relax.

Development, the chaise longue is also available with 3-position sliding mechanism to cater for all relaxation situations.

La chaise longue est également disponible avec mécanisme à glissement en trois positions pour chaque situation de relax.

Die Chaiselongue ist mit einem dreistufigen Schiebemechanismus für jede Entspannungssituation erhältlich.





I braccioli celano un pratico contenitore trapuntato per riporre il telecomando o altri oggetti. Grazie alla fettuccina, la fodera si solleva per una rapida pulizia.

The armrests conceal a practical quilted compartment to store the remote control and other objects. The tape enables the lining to be lifted for rapid cleaning.

Les accoudoirs cachent un conteneur pratique matelassé pour y déposer la télécommande ou autres objets. Grâce au ruban, la housse se soulève pour un nettoyage rapide.

In den Armlehnen verbirgt sich ein praktischer, gesteppter Behälter zur Aufbewahrung der Fernbedienung oder anderer Gegenstände. Dank des Gurtbandes kann die Abdeckung zur schnellen Reinigung angehoben werden.



Il ripiano in vetro cannetato della chaise longue estraibile offre non solo un dettaglio di stile, ma anche un comodo spazio di appoggio.

Le plan en verre cannelé de la chaise longue extractible offre non seulement un détail de style, mais aussi un espace d'appui confortable.

The canneté glass shelf on the extending chaise longue provides a stylish detail as well as a convenient space to stand things on.

Die gerippte Glasablage der ausziehbaren Chaiselongue ist nicht nur ein stilvolles Detail, sondern auch eine komfortable Ablagefläche.

Vibe

Vibrazioni sintonizzate sulle frequenze del comfort. Vibe è un'armonia di elementi che si muovono in perfetto accordo con le esigenze di chi lo vive. I poggiatesta regolabili, le sedute estraibili con meccanismo scorrevole in tre posizioni, la fascia di cuscini lombari creano un'esperienza su misura, arricchita dalla grazia della trapuntatura sui braccioli e degli alti piedini.

Vibrations tuned in to the comfort station. Vibe is a balance of elements that move in perfect harmony with the needs of the user. The adjustable headrest, pull-out seats with a three-point sliding mechanism, and row of lumbar cushions create a tailored style, enhanced by the quilted armrests and elongated feet.

Des vibrations réglées sur les fréquences du confort. Vibe est une harmonie d'éléments qui évoluent en parfaite adéquation avec les besoins de ceux qui l'utilisent. Les appuis-tête réglables, les assises amovibles avec un mécanisme coulissant à trois positions, et la bande de coussins lombaires créent une expérience sur mesure, enrichie par le charme du matelassage sur les accoudoirs et les pieds hauts.

Auf die Frequenzen des Komforts abgestimmte Vibrationen. Vibe ist eine Harmonie an Elementen, die sich im perfekten Einklang mit den Bedürfnissen der Person, die mit ihnen lebt, bewegen. Die verstellbare Kopfstütze, die herausziehbaren Sitzflächen mit einem drei-Positionen-Gleitmechanismus, der Gürtel an Lendenkissen schaffen ein Erlebnis nach Maß, die von der Steppnaht auf den Armlehnen und den hohen Füßen erhöht wird.





I cuscini poggiatesta, situati sulla parte bassa dello schienale, sostengono la zona lombare della schiena facilitando una corretta postura e il pieno benessere.

The lumbar cushions, at the bottom of the backrest, support the lower back and help to maintain a correct posture for overall comfort.

Les coussins lombaires, situés dans la partie inférieure du dossier, soutiennent la zone lombaire du dos, facilitant une posture correcte et un bien-être complet.

Die Nierenstützen unten an den Rückenlehnen unterstützen den Lendenbereich des Rückens, so dass man natürlich eine korrekte Position einnimmt für ein absolutes Wohlbefinden.



Vibe è in continuo mutamento per assecondare ogni richiesta. Le sedute sono facilmente estraibili in tre posizioni, mentre i poggiatesta sono singolarmente inclinabili in 15 regolazioni.

Vibe can be retuned to meet your changing needs. The seats can be easily pulled out into three different positions while the headrests can be individually adjusted to 15 positions.

Vibe évolue constamment pour répondre à chaque demande. Les assises sont facilement amovibles en trois positions, et les appuis-tête peuvent être inclinés individuellement avec 15 réglages.

Vibe befindet sich in ständiger Wandlung, um jeden Anspruch zu erfüllen. Die Sitzflächen sind leicht in drei Positionen herauszuziehen, während die Kopfstützen einzeln in 15 verschiedenen Winkeln gekippt werden können.





Glove

Forme e volumi che trasmettono la sensazione di un generoso relax: Glove è il fascino dello stile in piena comodità. Con i suoi caratteristici braccioli ripiegati, crea l'occasione di morbidi appoggi, anche da sdraiati.

Forms and volumes that convey a sense of generous relaxation: Glove is the charm of style combined with the utmost comfort. You can also use the characteristic fold-in armrests to provide soft support whilst lying down.

Formes et volumes qui transmettent la sensation d'un grand relax: Glove est le charme du style en plein confort. Avec ses accoudoirs repliés caractéristiques, il crée des appuis souples, même en position couché.

Formen und Volumen, die das Gefühl von Entspannung vermitteln: Glove steht für einen besonderen Stil und vollen Komfort. Mit seinen charakteristischen umgeklappten Armlehnen ermöglicht er eine weiche Abstützung, auch im Liegen.







Grazie ai due meccanismi elettrici, basta un pulsante per inclinare il poggiatesta e allungare la seduta fino alla posizione desiderata.

The two electric mechanisms allow you to simply press a button to tilt the headrest and lengthen the seat to your desired position.

Grâce aux mécanismes électriques, il suffit d'un bouton pour incliner l'appuie-tête et allonger l'assise dans la position désirée.

Durch die beiden elektrischen Mechanismen kann die Kopfstütze geneigt und der Sitz auf Knopfdruck in die gewünschte Position gebracht werden.



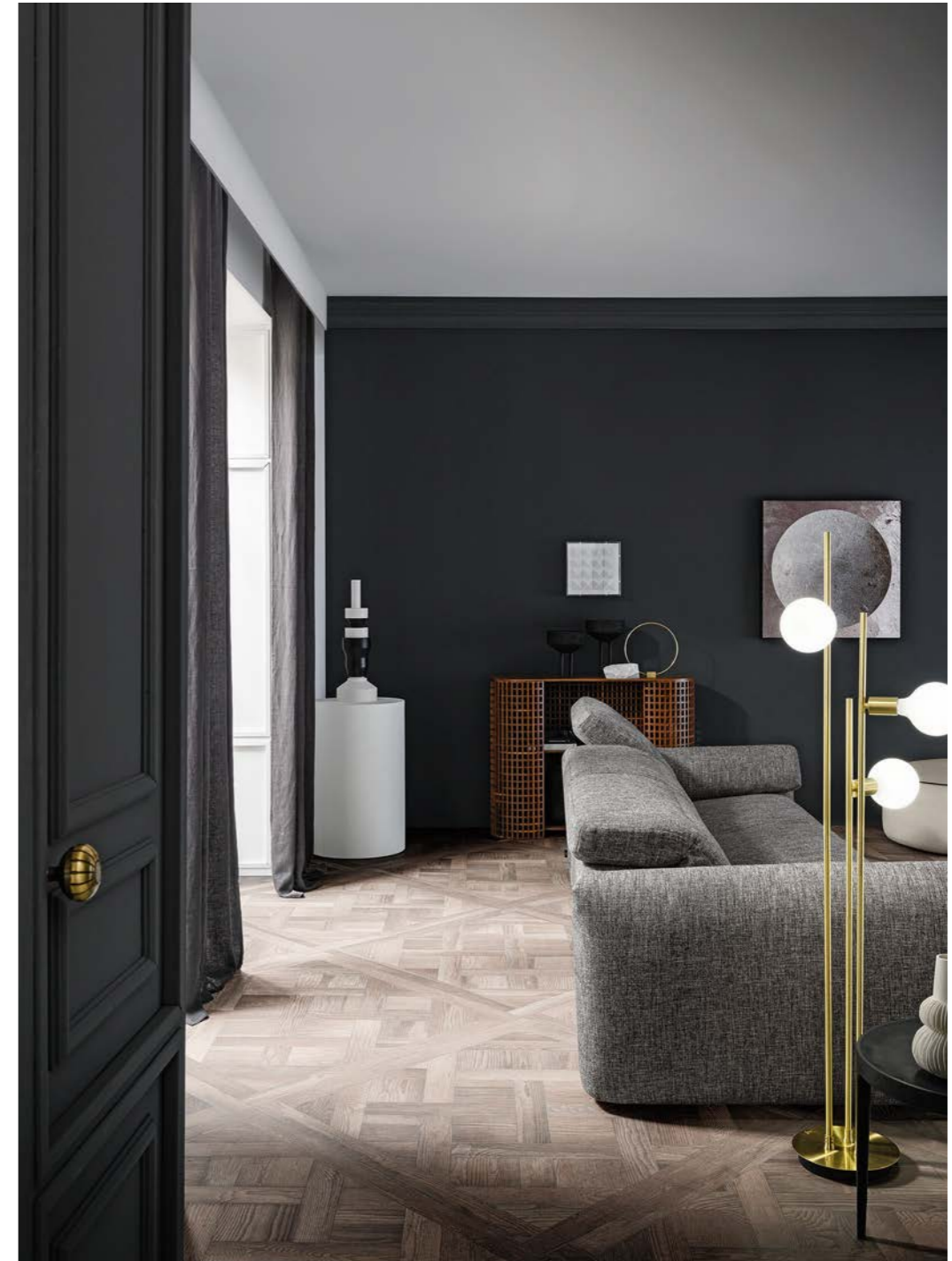





Kensington

Ampi braccioli, linee sinuose, morbidi cuscini filo terra che coprono tutta la seduta. La maestosa orizzontalità di Kensington è movimentata dalle cuciture trapuntate, raffinato tocco di stile. Nella versione elettrica, il doppio meccanismo recliner consente di regolare comodamente sia le sedute che i poggiatesta.

Broad armrests, sinuous lines and soft cushioning down to floor level covering the entire seat. The Kensington's magnificent horizontality is enhanced by the channel quilting, which adds an elegant, stylish touch. On the electric version, the double recliner mechanism conveniently adjusts both the seats and headrests.

Ample accoudoirs, lignes sinueuses, coussins souples jusqu'au sol qui recouvrent toute l'assise. La majestueuse horizontalité de Kensington est mouvementée par ses coutures matelassées, en style raffiné. Dans la version électrique, le mécanisme double recliner permet de régler confortablement les assises et les appuie-têtes.

Breite Armlehnen, Kurven, weiche Kissen, die mit dem Boden abschließen und die gesamte Sitzfläche abdecken. Die majestätische Horizontalität von Kensington wird durch die Steppnaht, eine raffinierte stilvolle Note, aufgelockert. In der elektrischen Version erlaubt der Recliner-Doppelmechanismus, die Sitzfläche und die Kopfstütze bequem zu verstellen.









Le possibilità di relax si moltiplicano abbinando moduli con meccanismi elettrici e manuali, insieme ad altri elementi come la chaise longue.

Your opportunities for relaxation are multiplied by combining sections featuring electric and manual recliner mechanisms with other sections such as the chaise longue.

Le relax se multiplie en combinant modules, mécanismes électriques et manuels, avec d'autres éléments comme la chaise longue.

Die Entspannungsmöglichkeiten vervielfachen sich durch die Kombination von Modulen mit elektrischen und manuellen Mechanismen sowie anderen Elementen wie beispielsweise der Chaiselongue.



La versione fissa è dotata di poggiatesta ergonomici regolabili in 15 posizioni per un'esperienza comfort su misura.

The fixed version is equipped with an adjustable 15-position ergonomic headrest so you can experience tailor-made comfort.

La version fixe est dotée d'appuie-têtes ergonomiques réglables en 15 positions pour offrir une expérience de confort sur mesure.

Die feste Ausführung ist mit ergonomischen Kopfstützen ausgestattet, die in 15 Positionen verstellt werden können und so für ein individuelles Komforterlebnis sorgen.





Angel

Possibilità compositive per grandi spazi. Lusso discreto di linee continue, rigorose ma morbide, precise ma, insieme, accoglienti.

Possible arrangements for large spaces. Discreet luxury of continuous lines, rigorous but soft, precise but cozy.

Possibilités de compositions pour les grands espaces. Luxe discret des lignes continues, rigoureuses mais délicates, précises mais chaleureuses à la fois.

Kompositionsmöglichkeiten für große Räume. Unaufdringlicher Luxus mit durchgehenden Linien, streng und doch weich, präzise und doch gemütlich.







Il design "continuum" dei piedini Ice. Sottili nell'appoggio, robusti nel collegamento agli angoli della struttura. Eleganti nella finitura brunita scura carbon look.

The seamless flow of the Ice feet. A slimline support but firmly attached to the corners of the structure. Stylish with their dark carbon look burnished finish.

Le « continuum » des pieds Ice. Fins dans l'appui, robustes dans la liaison avec les coins de la structure. Éléphants dans la finition brunie foncée carbon look.

Das " Continuum " Design der Füße Ice. Sie sind schmal in ihren Stützen und robust in ihrer Verbindung mit den Ecken der Struktur. Elegant im dunklen brünierten Carbon-Look.

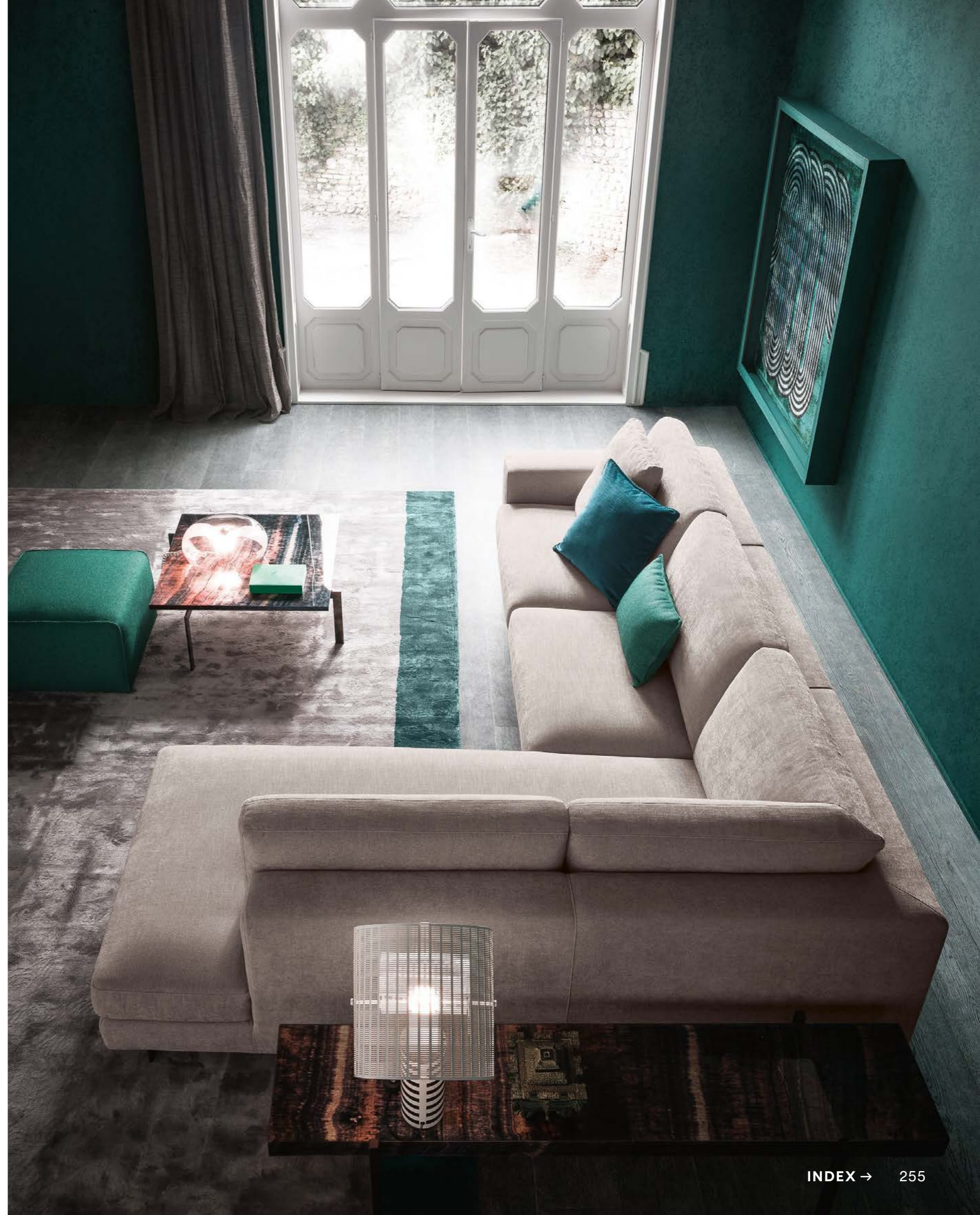







Icon

Morbida seduta racchiusa in un telaio dal carattere deciso: ecco Icon. I tubolari a vista e le linee pulite, risultato di una minuziosa ricerca formale, esaltano la sua raffinata personalità glam, ispirata al design dei progetti più iconici del Novecento.

Welcome to Icon: the soft seat enclosed within a frame sporting a strong character. The exposed tubular frame and clean-cut lines, the result of painstaking formal research, enhance its refined glamorous personality, inspired by the most iconic 20th century design projects.

Assise souple refermée sur un châssis au caractère décidé : voici Icon. Les tubulaires à vue et les lignes propres, résultat d'une minutieuse recherche des formes, exaltent sa personnalité glam raffinée, inspirée au design des projets plus iconiques du XXème siècle.

Weiche Sitzfläche in einem Rahmen mit starkem Charakter: das ist Icon. Die freiliegenden Rohre und die klaren Linien, die das Ergebnis einer sorgfältigen formalen Forschung sind, unterstreichen seine raffinierte und glamouröse Persönlichkeit, die vom Design der berühmtesten Projekte des 20. Jahrhunderts inspiriert ist.









I tubolari, tratto distintivo di Icon, si presentano in sei colori pastello e fluo, ideali sia in tinta che in contrasto con l'ampia scelta di tessuti.

The tubular frame, Icon's distinguishing feature, comes in six pastel shades and fluorescent colors, ideal to either match with or provide a contrast to the wide choice of fabrics.

Les tubulaires, trait distinctif de Icon, se présentent en six couleurs pastel et fluo, idéaux que ce soit en teinte qu'en contraste avec un choix ample de tissus.

Die Rohre, ein Kennzeichen von Icon, sind in sechs Pastell- und Neonfarben erhältlich, die ideal mit der großen Auswahl an Stoffen harmonisieren oder kontrastieren.



Nemo

Un divano a pozzetto compatto, versatile, ideale per ogni ambiente: un living domestico, la hall di un hotel, uno studio arredato con gusto. Nello stesso tempo, Nemo non rinuncia ai vezzi estetici e all'armonia delle linee, così come al comfort dei suoi cuscini lombari.

A compact, versatile, barrel-back sofa ideal for any setting: home living area, hotel lobby, studio furnished with flair. Nemo however still maintains its aesthetic quirks and harmonious lines, as well as the comfort of its lumbar cushions.

Un canapé arrondi compact, polyvalent, idéal pour quelconque milieu : un salon domestique, le hall d'un hôtel, un studio meublé avec goût. En même temps, Nemo ne renonce pas aux charmes esthétiques et à l'harmonie des lignes, ainsi qu'au confort de ses coussins lombaires.

Ein kompaktes, vielseitiges Cockpitsofa, ideal für jede Umgebung: das eigene Wohnzimmer, eine Hotellobby, ein geschmackvoll eingerichtetes Arbeitszimmer. Dabei verzichtet Nemo nicht auf optische Feinheiten und harmonische Linienführung sowie auf den Komfort seiner Lendenkissen.







La fascia di cuscini per il sostegno lombare è rimovibile e caratterizza anche la poltroncina Nemo.

The band of cushions providing lumbar support can be removed and is also featured on the Nemo armchair.

La bande des coussins pour le soutien lombaire est amovible et caractérise également le petit fauteuil Nemo.

Das Kissenband für die Lendenwirbelstütze lässt sich abnehmen und kennzeichnet auch den Sessel Nemo.

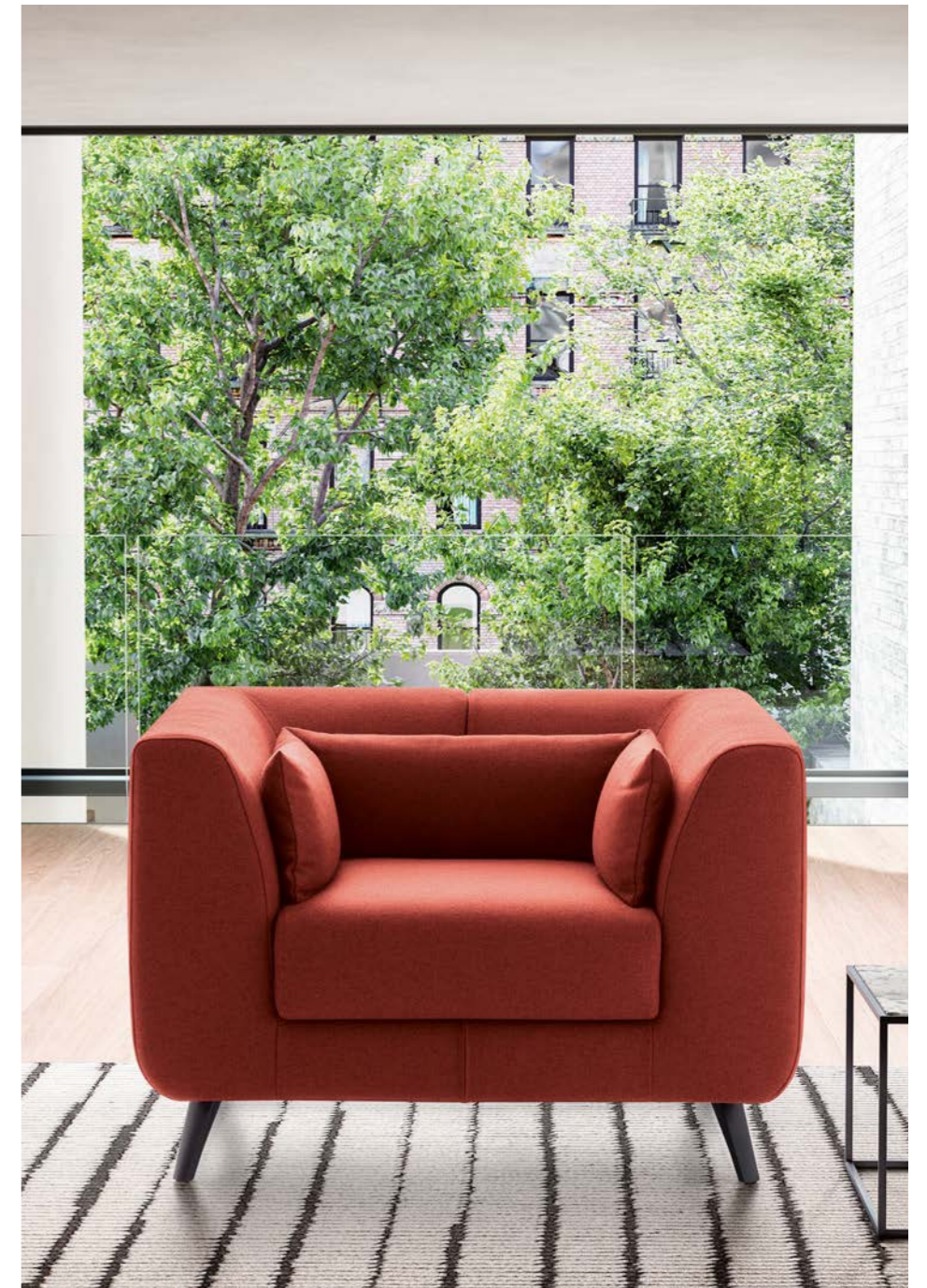



Clair

La forma arrotondata dello schienale incontra le linee più squadrate dei braccioli. Clair è il luogo ideale per abbandonarsi al relax, magari immersi in un buon libro, come suggeriscono gli ambienti dalla raffinata impronta industrial di queste pagine.

The rounded backrest meets the more square lines of the armrests. Clair is the ideal place to indulge in relaxation, perhaps immersed in a good book, as suggested by the refined industrial stamp of the rooms here.

La forme arrondie du dossier rencontre les lignes plus carrées des accoudoirs. Clair est le lieu idéal pour s'abandonner au relax, éventuellement immergé dans un bon livre, comme le suggèrent les milieux aux empreintes industrial raffinées de ces pages.

Die abgerundete Form der Rückenlehne wird durch die eckigeren Linien der Armlehnen ergänzt. Clair ist der ideale Ort, um sich zu entspannen, womöglich in ein gutes Buch vertieft, wie es das raffinierte industrielle Ambiente dieser Seiten nahelegt.







Lizzie

Una curva inattesa spezza la prevedibilità delle geometrie. In quel capriccio del bracciolo emerge con forza l'identità visiva di Lizzie, equilibrata ribellione delle forme che sdrammatizza con classe anche la formalità di un ambiente classico moderno.

An unexpected curve breaks up the predictability of the geometric shapes. Lizzie's visual identity emerges with all its force in the whim of the armrest, as shape rebels with restraint, tastefully playing down the formality of a modern classic environment.

Une courbe inattendue casse la prévisibilité des géométries. Dans ce caprice de l'accoudoir l'identité visuelle de Lizzie apparaît avec force, rébellion équilibrée des formes qui dédramatise avec classe également la formalité d'un milieu classique moderne.

Eine unerwartete Kurve unterbricht die Vorhersehbarkeit der Geometrien. Die optische Identität von Lizzie kommt dank der eigenwilligen Armlehne kraftvoll zum Vorschein, eine ausgewogene Rebellion der Formen, die selbst die Formalität einer modernen, klassischen Umgebung mit Eleganz überspielt.





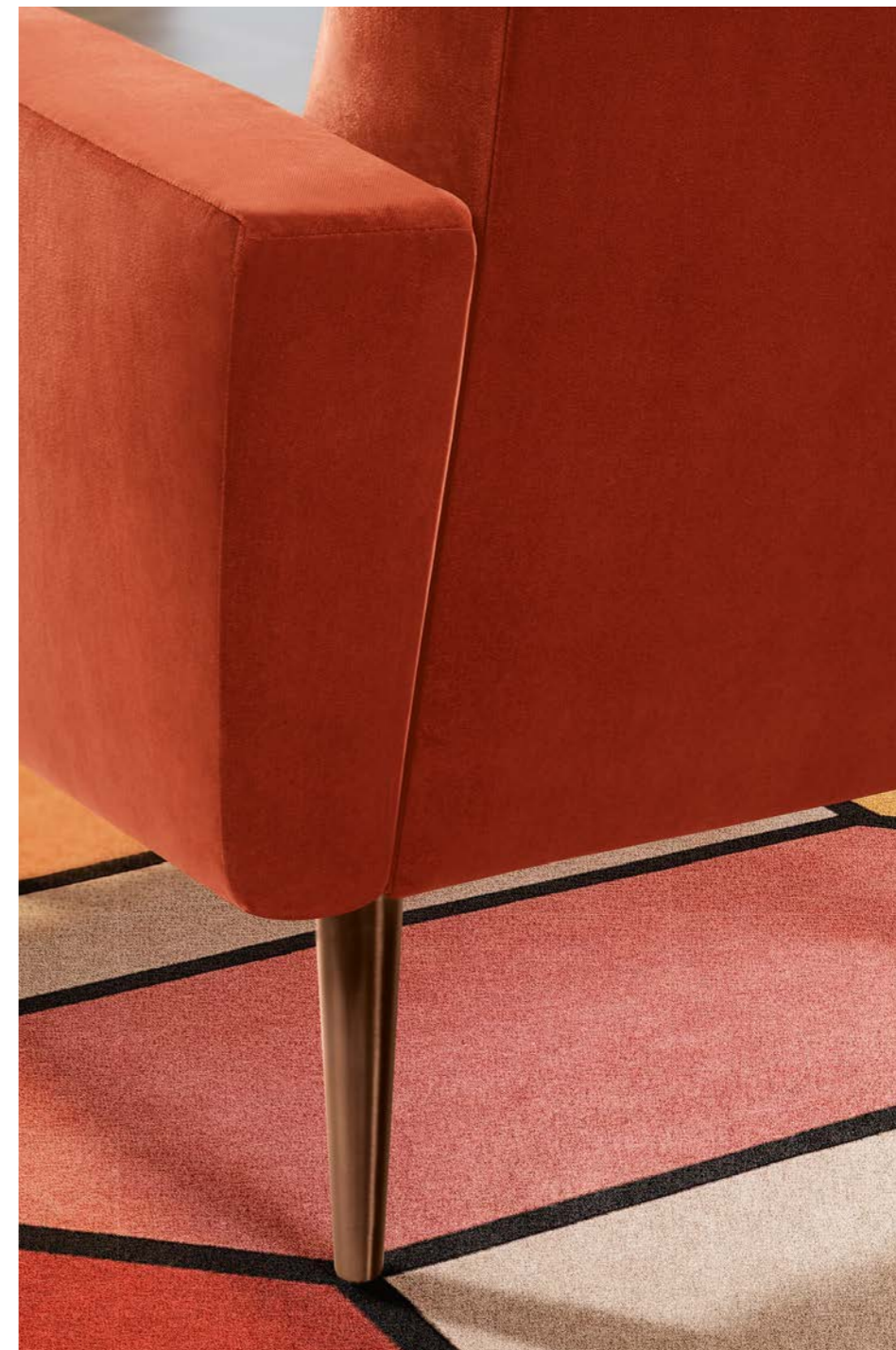

Wendy

L'imponenza dei braccioli racchiude in un abbraccio la morbida seduta. È impossibile resistere a Wendy e alla promessa di comfort custodita nelle linee armoniosamente rotonde del suo design, ideali per valorizzare anche le stanze più eleganti.

The grandeur of the armrests encloses the soft seating in an embrace. It's impossible to resist Wendy and the promise of comfort embodied in the harmoniously rounded design, the ideal way to embellish even the most elegant rooms.

La grandeur des accoudoirs renferme dans l'avant-bras une assise souple. Il est impossible de résister à Wendy et à la promesse de confort cachée dans les lignes harmonieuses arrondies de son design, idéales pour valoriser également les chambres les plus élégantes.

Die beeindruckenden Armlehnen umschließen den weichen Sitz wie eine Umarmung. Man kann Wendy nicht widerstehen, und das Versprechen von Komfort, das in den harmonisch abgerundeten Linien seines Designs steckt, ist ideal, um selbst die elegantesten Räume aufzuwerten.



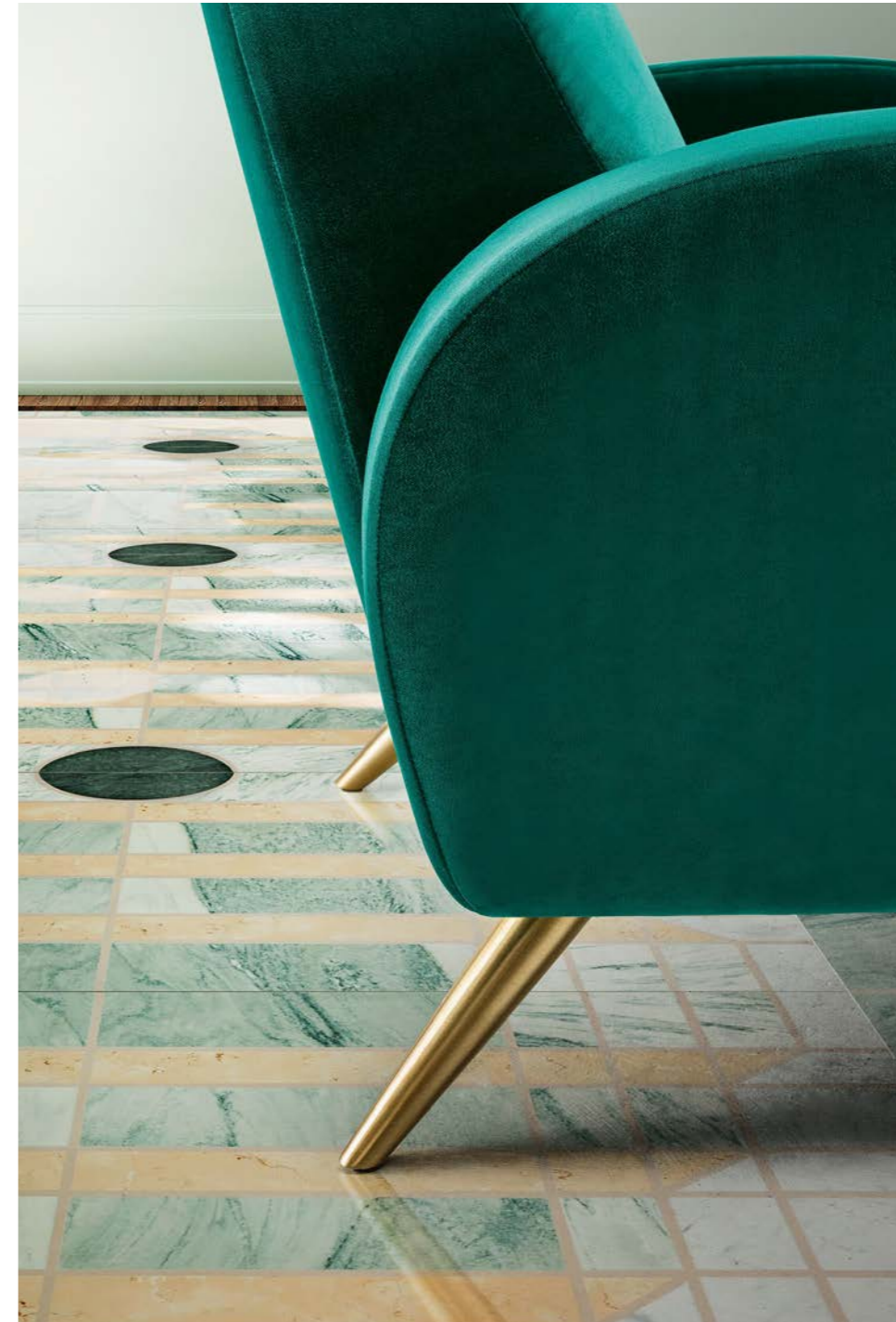



Tubes

Regina del living come della sala da pranzo, Tubes è disponibile in due diverse altezze. La sua inconfondibile raffinatezza estetica si sposa con un comfort che conquista alla prima seduta e con la praticità di un'ampia gamma di tessuti 100% sfoderabili.

Tubes reigns supreme in the living area as well as the dining room, as it is available in two different heights. Its unmistakable refined sophistication combines with an irresistibly comfortable seating experience and the practicality of a wide range of 100% removable fabrics.

Roi du salon comme de la salle à manger, Tubes est disponible en deux hauteurs. Son raffinement esthétique unique se marie avec un confort qui conquiert à la première assise et grâce aussi à son ample gamme de tissus 100% déhoussables très pratique.

Tubes, die Königin des Wohn- und Esszimmers, ist in zwei verschiedenen Höhen erhältlich. Die unverwechselbare ästhetische Raffinesse verbindet sich mit einem Komfort, der Sie schon beim ersten Hinsetzen überzeugt, dazu kommt eine breite Palette von 100% abziehbarer Stoffe.







Tubes è un robusto e comodo abbraccio, caratterizzato dall'originale design a cuscini cilindrici che dà forma a schienale e seduta.

Tubes provides a strong, comfy embrace due to the original design of cylindrical cushions, which form the backrest and seat.

Tubes est un enlacement robuste et confortable, caractérisé par un design original aux coussins cylindriques qui donnent forme au dossier et à l'assise.

Tubes ist wie eine robuste und bequeme Umarmung, die durch das originelle Design der zylindrischen Kissen besticht, die die Rückenlehne und den Sitz formen.



La base girevole in acciaio satinato è dotata di meccanismo di ritorno automatico per riportare sempre la poltroncina alla posizione originale.

The satin-finish steel swivel base is fitted with a return mechanism, which automatically brings the armchair back to its original position.

La base pivotante en acier satiné est dotée d'un mécanisme de retour automatique pour ramener toujours le petit fauteuil dans la position originale.

Das Drehgestell aus satiniertem Stahl ist mit einem automatischen Rückstellmechanismus ausgestattet, der den Sessel immer in seine ursprüngliche Position zurückbringt.



Love & Story

Morbidi momenti di felicità, da vivere insieme. Love e Story sono una coppia di poltroncine in perfetta sintonia, un'armonia di forme e colori ideale per ogni ambiente, dal living alle camerette. Grazie alla maniglia e alle rotelle a scomparsa è facile spostarle ogni volta che si vuole.

Soft moments of happiness to live together. Love and story are an armchair couple matched perfectly, a harmony of shapes and ideal colours for each setting, from the living room to the children's bedrooms. Easy to move each time, thanks to the retractable handle and wheels.

Instants doux de félicité, à vivre ensemble. Love et Story sont un couple de petits fauteuils en parfaite syntonie, une harmonie de formes et de couleurs idéales pour quelconque milieu, du salon aux chambres. Grâce aux poignées et aux roues escamotables ils sont faciles à déplacer, chaque fois que vous le désirez.

Glücksmomente, die man gemeinsam erleben kann. Love und Story sind ein perfekt aufeinander abgestimmtes Sesselpaar, eine Harmonie von Formen und Farben, das ideal für jeden Raum ist, vom Wohn- bis zum Kinderzimmer. Der Griff und die einziehbaren Rollen sorgen dafür, dass man sie jederzeit leicht bewegen kann.





Story si distingue per lo schienale ovale. La maniglia in cuoio è pensata per muovere in tutta comodità le poltroncine sulle rotelle gommate, senza rovinare il pavimento.

Story is distinguished for its oval backrest. The leather handle was designed to comfortably move the armchairs on the rubber wheels without ruining the floor.

Story se différencie par son dossier ovale. La poignée en cuir est créée pour bouger tout en confort les petits fauteuils sur roues caoutchoutées, sans endommager le sol.

Story zeichnet sich durch seine ovale Rückenlehne aus. Der Ledergriff ist so konzipiert, dass man den kleinen Sessel bequem auf Gummirollen bewegen kann, ohne den Boden zu beschmutzen.

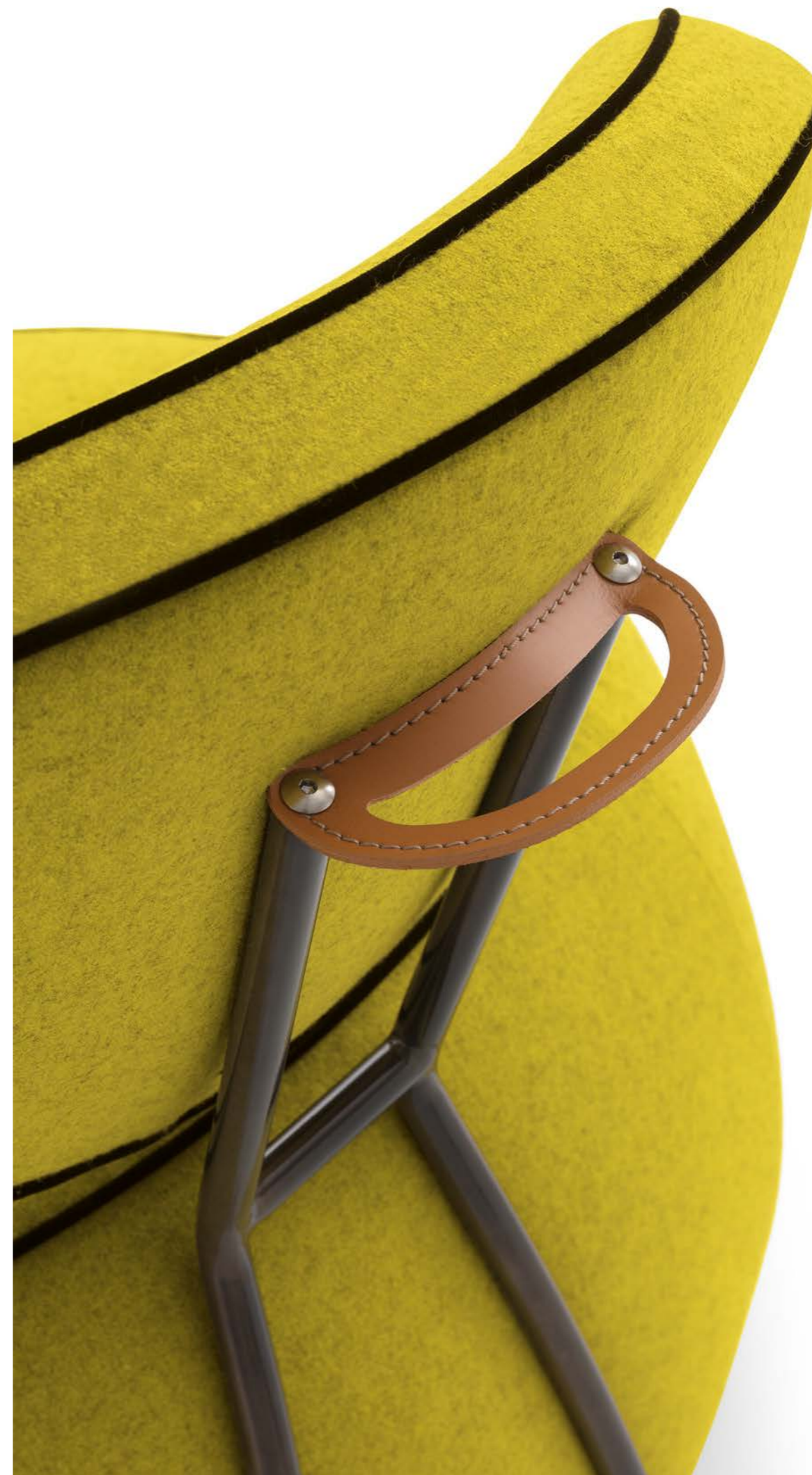



**Love, con il suo
caratteristico schienale
a cuore, è un sensuale
invito a mettersi comodi.
I cordoncini che ne
evidenziano le linee
curve possono essere in
tinta o a contrasto.**

Love with its characteristic heart-shape backrest, a sensual invitation to get comfortable. The cords follow the curved lines and can be of solid colour or contrasting colours.

Love, avec son dossier caractéristique en forme de cœur, est une invitation sensuelle à s'installer confortablement. Les cordonnets qui mettent en valeur ses lignes courbes peuvent être en teinte ou en contraste.

Love, mit seiner charakteristischen Rückenlehne in Herzform, steht für eine verlockende Einladung, es sich bequem zu machen. Die Kordeln, die seine geschwungenen Linien hervorheben, können entweder farblich abgestimmt oder kontrastierend sein.



Sigmund

Una panchetta imbottita che rievoca, rivisitandolo, il gusto di un design anni '50-'60. Sigmund offre diverse possibilità di arredo che combinano uno stile ricercato - definito dalle estrose linee dei suoi cuscini e piedini - con la massima funzionalità in tutti gli spazi di casa.

Padded bench, revoking and revisiting a taste of design of the 50s and 60s. Sigmund offers various furnishing possibilities that combine a refined style, defined by the fancy lines of its cushions and feet with utmost functionality for any part of the house.

Une banquette rembourrée qui rappelle, en le revisitant, le goût d'un design des années 50-60. Sigmund offre différentes possibilités de décoration qui associent un style recherché - défini par les lignes fantaisistes des coussins et des petits pieds - avec une fonctionnalité maximale dans tous les espaces de la maison.

Die gepolsterte Bank lässt den Geschmack des Designs der 1950er bis 1960er Jahre wieder aufleben. Sigmund bietet verschiedene Einrichtungsmöglichkeiten, die einen raffinierten Stil - definiert durch die ausgefallenen Linien seiner Kissen und Füße - mit maximaler Funktionalität in allen Bereichen des Hauses verbinden.







Sigmund è in versione doppio cuscino o con vassoio portaoggetti in vetro cannettato. I piedini sono disponibili in quattro finiture.

Sigmund with dual cushion or with ribbed glass object-holder tray. Feet are available in four finishes.

Sigmund existe dans la version double coussin ou plateau porte-objets en verre canneté. Les petits pieds sont disponibles en quatre finitions.

Sigmund ist in einer Ausführung mit Doppelkissen oder mit einem Ablagefach aus geripptem Glas erhältlich. Die Füße sind in vier Ausführungen erhältlich.



Prince

Divertente, morbido, creativo. Prince colora ogni ambiente portando vivacità e freschezza. Prince è il gusto di giocare con i contrasti dei cordoncini e delle cuciture sartoriali per far emergere il tuo stile. Disponibile in sei diverse varianti, tutte facilmente sfoderabili, Prince è il pouf che cercavi per dare personalità ai tuoi spazi.

Cheerful, soft and creative. Prince brings fresh, vibrant colour into any room. Prince is the joy of playing with contrasting piping and tailored stitching to bring out your style. Available in six different versions, all with easily removable covers. Prince, the pouf you were looking for to give your space personality.

Amusant, doux, créatif. Prince colore chaque milieu en y apportant dynamisme et fraîcheur. Prince est le plaisir de jouer avec les contrastes des cordonnets et des coutures de haute couture afin de faire émerger votre style. Disponible en six versions différentes, toutes facilement déhoussables, Prince est le pouf que vous cherchez pour donner personnalité à vos espaces.

Witzig, weich, kreativ. Prince bringt Farbe in jeden Raum und sorgt für Lebendigkeit und Frische. Prince versteht es, mit kontrastierenden Schnüren und maßgeschneiderten Nähten zu spielen, um Ihren Stil zu unterstreichen. Erhältlich in sechs verschiedenen Ausführungen, die alle leicht abnehmbar sind, ist Prince der Hocker, nach dem Sie schon lange gesucht haben und der Ihren Räumen Persönlichkeit verleiht.





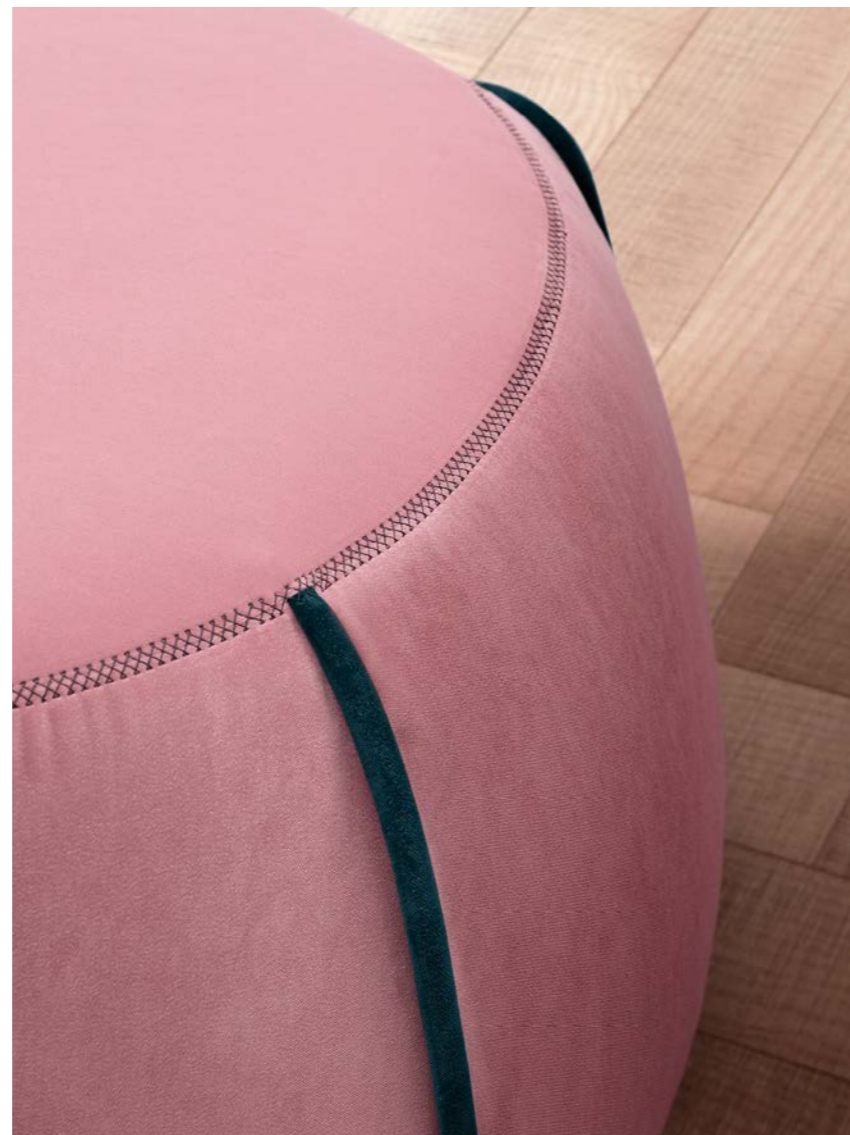

Prince è l'arte di arredare con combinazioni inaspettate di forme e colori. Ma non è solo estetica: ogni pouf è un'irresistibile tentazione di comfort.

Prince is the art of furnishing through unexpected combinations of shapes and colors. But it goes beyond aesthetics: every ottoman is an irresistible temptation to get comfortable.

Prince est l'art de décorer avec des combinaisons de formes et couleurs inattendues. Mais non seulement esthétiques : chaque pouf est une tentation irrésistible de confort.

Prince steht für die Kunst des Einrichtens mit unerwarteten Kombinationen von Formen und Farben. Allerdings geht es nicht nur um Ästhetik: Jeder Pouf ist ein verlockendes Beispiel für Komfort.



Pills

Un felice gioco di contrasti tra le linee dritte dei piedini e le morbide curve dell'imbottitura. Così nasce la collezione Pills, che offre diverse possibilità di personalizzazione: forme tonde, quadrate, rettangolari ed ellissoidali, sedute in tre diverse altezze e piedini in quattro finiture.

An attractive interplay of contrasts between the straight lines of the feet and the smooth curves of the padding. The Pills collection offers various possibilities for customisation: round, square, rectangular and elliptical shapes, seats in three different heights and feet in four finishes.

Un jeu heureux de contrastes entre les lignes droites des pieds et les douces courbes du rembourrage. Ainsi né la collection Pills, qui offre différentes possibilités de personnalisation: formes rondes, carrées, rectangulaires et hélicoïdales, assises de trois différentes hauteurs et pieds en quatre finitions.

Ein fröhliches Spiel der Kontraste zwischen den geraden Linien der Füße und den weichen Kurven der Polsterung. Die Kollektion Pills bietet verschiedene Möglichkeiten der individuellen Gestaltung: runde, quadratische, rechteckige und ellipsenförmige Formen, Sitze in drei verschiedenen Höhen und Füße in vier Ausführungen.



Flamingo

Il fascino della leggerezza si sposa con la solidità della struttura e con l'eleganza del marmo, proposto in due finiture. La collezione di tavolini Flamingo è di alto livello e offre differenti forme per il piano, diverse altezze e quattro varianti per i piedini: cromo, oro, rame e carbon look.

The charm of lightness combines with the solidity of the frame and the elegance of marble proposed in two finishes. The Flamingo collection of coffee tables is high quality and offers a variety of different shapes for the top, various heights and four variations of feet: chrome, gold, copper and carbon look.

Le charme de la légèreté se marie avec la solidité de la structure et avec l'élégance du marbre, proposé en deux finitions. La collection de tables basses Flamingo est de haut niveau et offre différentes formes pour le plateau, différentes hauteurs et quatre variantes de pieds: chrome, or, cuivre et look carbone.

Der Charme der Leichtigkeit verbindet sich mit der Stabilität der Struktur und der Eleganz des Marmors, der in zwei Ausführungen angeboten wird. Die Beistelltisch-Kollektion Flamingo zeichnet sich durch einen hohen Standard aus und bietet verschiedene Formen für die Tischplatte, verschiedene Höhen und vier verschiedene Fußausführungen: Chrom, Gold, Kupfer und Carbon-Look.



Nemesi

Essenziale, elegante, versatile: Nemesi è il programma di pouf e tavolini di diverse dimensioni ideale per creare, con semplicità, isole di comfort da vivere. La struttura tubolare è la stessa, le funzioni sono differenti grazie alla possibilità di scegliere piani imbottiti, gres o in vetro.

Essential, elegant and versatile. Nemesi is the plan of poufs and tables of different sizes, ideal for creating comfortable living islands with simplicity. The tubular structure is the same, but the functions are different thanks to the possibility of choosing padded, stoneware or glass tops.

Essentiel, élégant, polyvalent : Nemesi est le programme idéal de poufs et de tables basses de différentes dimensions pour créer, avec simplicité, des îles de confort à vivre. La structure tubulaire est la même, les fonctions sont différentes grâce à la possibilité de choisir les plans rembourrés, en grès ou en verre.

Schlicht, elegant, vielseitig: Nemesi ist das Programm von Poufs und Beistelltischen in verschiedenen Größen, ideal, um gemütliche Wohninseln zu schaffen. Die Rohrstruktur ist dieselbe, die Funktionen unterscheiden sich dank der Möglichkeit, zwischen gepolsterten, Steingut- oder Glasplatten zu wählen.





Oltre a creare un raffinato gioco di linee, la struttura sottile e leggera consente di spostare comodamente gli elementi per realizzare nuove configurazioni.

Besides creating a refined illusion of lines, the thin, light structure allows for elements to be comfortably moved to create new configurations.

Outre à créer un jeu de lignes raffiné, la structure fine et légère permet de déplacer confortablement les éléments pour réaliser de nouvelles configurations.

Die filigrane und leichte Struktur sorgt nicht nur für ein raffiniertes Linienspiel, sondern auch dafür, dass die Elemente bequem verschoben werden können, um neue Konfigurationen zu erhalten.

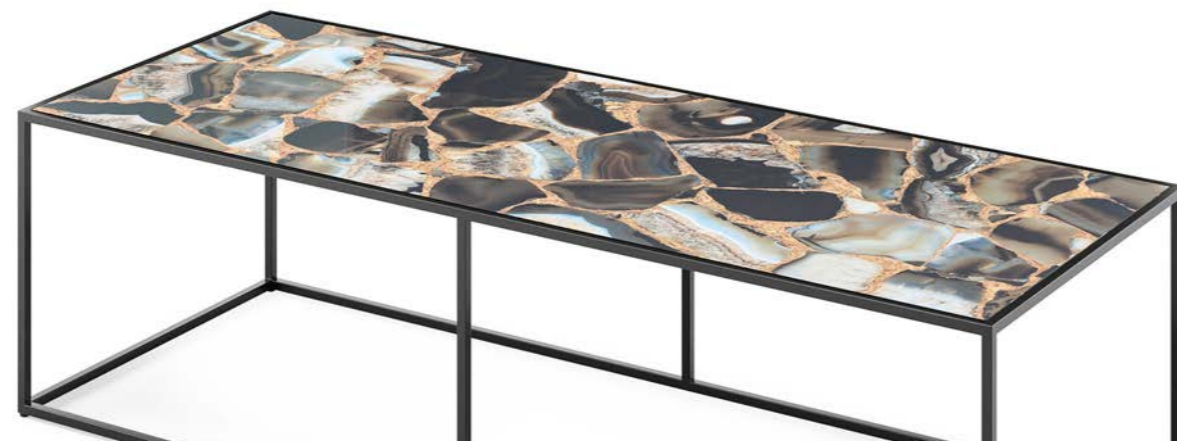

Cushions & Pouf

Questione di stile, questione di morbidezza. La collezione di pouf e cuscini Felis aggiunge quel dettaglio in più capace di dare un'impronta personale agli spazi del nostro vivere quotidiano. Tecnologici, grazie alla dock station per ascoltare la propria musica preferita; capienti, grazie al vano contenitore; personalizzabili, grazie ai bordini e alle cuciture a contrasto o in tinta: ce n'è davvero per tutti i gusti, in diverse forme e dimensioni.

A question of style, a question of softness. The Felis collection of ottomans and cushions adds that extra detail, giving the spaces we live our daily lives in that personal touch. Technological, thanks to the dock station for listening to our favorite music; spacious, thanks to the storage compartment; customizable thanks to the contrasting or matching trim and stitching: there truly is something for everyone, in various shapes and sizes.

Question de style, question de souplesse. La collection Felis de poufs et de coussins ajoute le détail en plus capable de donner une empreinte personnelle aux espaces de notre vivre quotidien. Technologiques, grâce à la station dock pour écouter la propre musique préférée ; spacieux, grâce au compartiment conteneur ; personnalisables, grâce aux bords et aux coutures en contraste ou en teinte : il y en a vraiment pour tous les goûts, en différentes formes et dimensions.

Es geht um Stil, es geht um Weichheit. Die Kissen- und Pouf-Kollektion Felis ist ein zusätzliches Detail, das unseren Wohnräumen einen ganz persönlichen Touch verleiht. Sie ist technologisch, dank der Docking-Station zum Abspielen Ihrer Lieblingsmusik; sie ist geräumig, dank des Staufachs; sie ist individuell gestaltbar, dank der kontrastierenden oder farblich abgestimmten Einfassungen und Nähte: für jeden ist etwas dabei, in verschiedenen Formen und Größen.



Ritual



Liberi di spostarlo come un cuscino, comodi come su uno schienale regolabile. Chi ama il comfort, non può non amare Ritual. Dotato di cricchetto, può essere inclinato in 14 diverse posizioni per trovare, in ogni momento, la propria preferita.

Rearrange it like a cushion and get comfy with the adjustable backrest. If you are a fan of comfort, then you'll love Ritual. It can be adjusted to 14 different positions to find the perfect angle to suit your needs.

La liberté de le déplacer comme un coussin, le confort comme sur un dossier réglable. Quiconque aime le confort ne peut s'empêcher d'aimer Ritual. Doté d'une charnière de réglage, il s'incline dans 14 positions différentes pour trouver à tout moment celle que vous préférez.

Frei verschiebbar wie ein Kissen, bequem wie eine verstellbare Rückenlehne. Wer Komfort liebt, kommt nicht umhin, Ritual zu lieben. Mit einer Ratsche kann es in 14 verschiedene Positionen eingestellt werden, um in jedem Moment, seine Lieblingsposition zu finden.



Daisy



Bryan



Candy



Isabel





Mya



Carol



Maury



Charlie



Parole d'ordine: cura sartoriale e personalizzazione.
Ogni cuscino può essere realizzato su misura, scegliendo i tessuti, le finiture e le dimensioni che meglio si adattano ai propri gusti ed esigenze di benessere.

Watchwords: tailoring and personalisation. Every cushion can be made-to-measure by choosing the fabrics, finishes and sizes that best fit your own personal style and comfort requirements.

Les mots d'ordre : soin sartorial et personnalisation.
Chaque coussin peut être réalisé sur mesure, en choisissant les tissus, les finitions et les dimensions qui correspondent le mieux à vos goûts et à vos besoins de bien-être.

Losungswort: Sorgfalt im Schnitt und Personalisierung.
Jedes Kissen kann nach Maß mit den Stoffen, Endbearbeitungen und Abmessungen angefertigt werden, die am besten zum Geschmack und dem subjektiven Wohlbefinden seines Besitzers passt.



Clara



Conny



Ben



Clyde

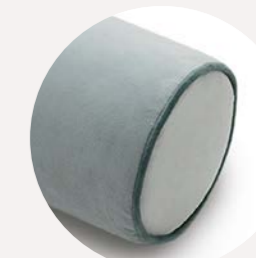



Cubik



Billy



Pam



Pika



Ted

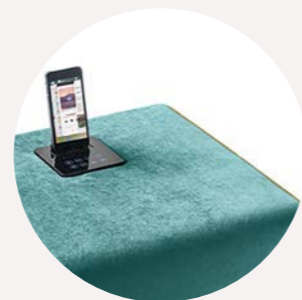

Zeppelin

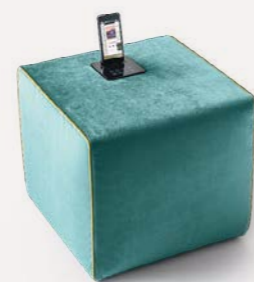

Secret

Secret big

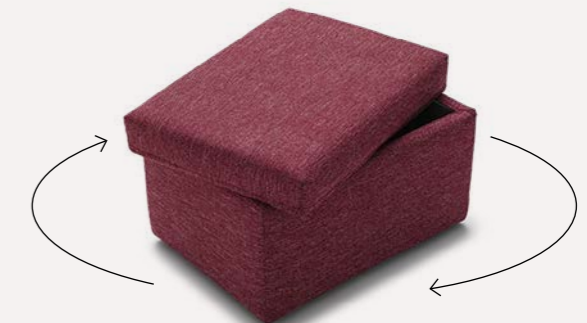

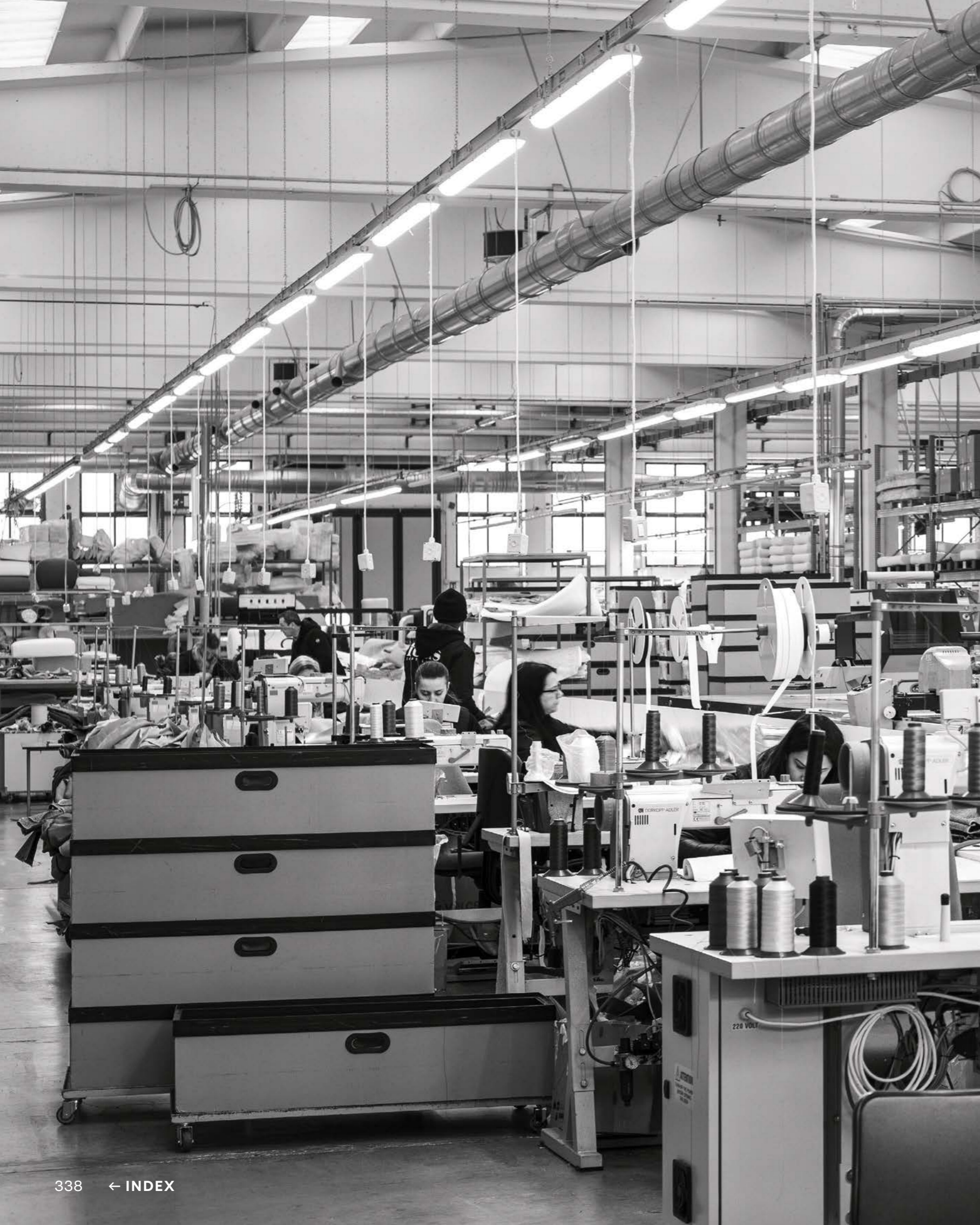

Technical Information

→ Soft Living

- 340 All-in
- 342 Angel
- 346 Capitol
- 348 Conrad
- 352 Float
- 354 Glove
- 360 Gravity
- 362 Icon
- 364 Kensington
- 370 Larson
- 374 Limitless
- 363 Muffin
- 378 Nemo
- 380 Pantheon
- 386 Platform
- 390 Reverso
- 394 Vibe

→ Armchair & Complementi

- 344 Clair
- 350 Flamingo
- 344 Lizzie
- 376 Love & Story
- 377 Nemesi
- 382 Pills
- 388 Prince
- 392 Sigmund
- 393 Tubes
- 344 Wendy

→ Pouf & Cushions

- 396 Cushions
- 404 Pouf

All-in

COMPLETAMENTE SFODERABILE / COMPLETELY REMOVABLE FABRIC COMPLÈTEMENT DÉHOUSSABLE / VOLLSTÄNDIG ENTFERNBAR

STRUTTURA

Realizzata con masselli in legno di abete massiccio di vari spessori. Parti di tamponamento in fibra grezza e/o compensato di pioppo. Fianchi in agglomerato di legno a bassa emissione di formaldeide (appartenente alla Classe E1). Braccioli dotati di vano contenitore. Poggiatesta dotato di cricchetto estraibile in acciaio con finitura cromo lucido. Possibilità di regolare l'inclinazione a seconda del proprio comfort.

IMBOTTITURA

Cuscino seduta in espanso indeformabile in D35 / D40 il tutto rivestito in resinato di poliesteri 200 gr. Schienale in espanso D16 indeformabile, rivestito in resinato di poliesteri 200 gr. Poggiatesta in espanso indeformabile in D28, dotato di cricchetto con innesto su bussola in acciaio con finitura cromo lucido.

MECCANISMO

Meccanismo sottoposto a severi test di resistenza. Seduta dotata di meccanismo scorrevole in metallo a 3 posizioni con cinghiatura elastica.

PIEDI

In alluminio pressofuso lucidato meccanicamente - H 130 mm.

FRAME

Made of solid fir wood in various thicknesses. Reinforcement parts in wood fibre and/or plywood. Sides made of 18 mm particleboard and/or multi-layered wood. Wood fibre and particleboard Class E1 therefore low formaldehyde emissions. Armrests fitted with storage compartment. Headrest equipped with polished chrome finish steel pull-out ratchet. Inclination can be adjusted to suit user.

PADDING

Seat cushion padding made of nondeformable D35 / D40 foam covered with 200 g polyester resin. Back made of D16 non-deformable foam upholstered with 200 g polyester resin. Headrest made of D28 non-deformable polyurethane foam, complete with ratchet fitted onto a polished chrome finish steel bushin.

MECHANISM

Mechanism subject to strict resistance testing. Seat fitted with metal sliding mechanism featuring 3 positions with elasticated webbing.

FEET

Made of die-cast aluminium polished mechanically - H 130 mm.

STRUCTURE

Réalisée en bois massif de pin portant de différentes épaisseurs. Fileurs de remplissage en fibre brute et/ou contreplaqué. Côtés en aggloméré de bois et/ou multicouches de bois 18 mm. Fibre brute et aggloméré de bois en Classe E1, donc à basse émission de formaldéhydes. Accoudoirs équipés de compartiment conteneur. Appui-tête doté de cliquet extractible en acier avec finition chrome brillant. Possibilité de régler l'inclinaison selon le propre confort.

REMOURRAGE

Coussin assise en expansé indéformable de polyuréthane D35/D40, le tout revêtu en résiné de polyester 200 gr. Dossier en expansé indéformable de polyuréthane D16, revêtu en résiné de polyester 200 gr. Appui-tête en expansé indéformable de polyuréthane D28, doté de cliquet avec bouton sur boussole en acier finition chrome brillant.

MÉCANISME

Mécanisme soumis à de sévères tests de résistance. Assise dotée d'un mécanisme coulissant en métal à 3 positions avec sangle élastique.

PIEDS

Pieds en aluminium moulés sous pression, mécaniquement - H. 130 mm.

KORPUS

Aus massivem Tannenholz in verschiedenen Stärken, Füllungen aus Rohfaser und/oder Sperrholz. Seiten aus 18 mm Spanplatte. Alles entspricht der Klasse E1, also mit geringer Formaldehydabgabe. Armlehnen mit Ablagefach. Die Neigung lässt sich in 15 Positionen einstellen. Der Mechanismus wird strengen Beständigkeitsprüfungen unterworfen.

POLSTERUNG

Sitzkissen aus formstabilem Schaumstoff D35/D40, verkleidet mit einer heiß verbundenen Schicht zu 200g. Rückenlehne aus formstabilem Schaumstoff D16, verkleidet mit einer heiß verbundenen Schicht zu 200g. Kopfstütze mit Mechanismus, aus formstabilem Schaumstoff in D28, ausgestattet mit einer Ratsche mit einer Stahlkompasshalterung mit poliertem Chrom.

MECANISMUS

Der Mechanismus wird strengen Beständigkeitsprüfungen unterworfen. Der Sitz ist mit einem metallischen 3-Positionen-Schiebemechanismus und elastischen Gurten ausgestattet.

FÜSSE

Aus mechanisch poliertem Aluminium-Druckguss - H 130 mm.

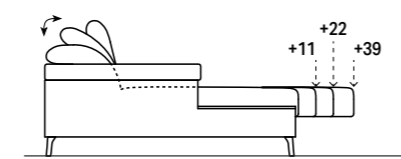
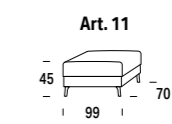
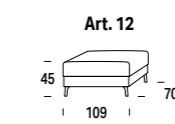
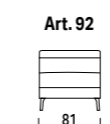
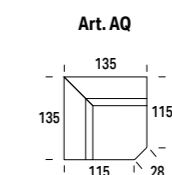
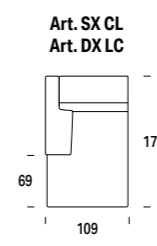
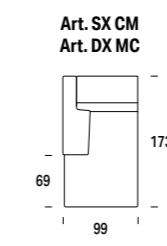
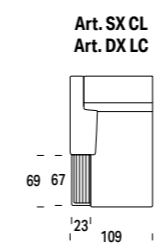
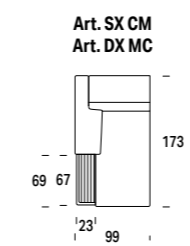
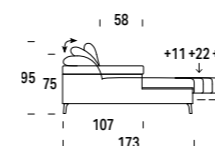
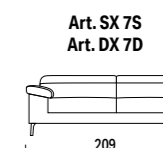
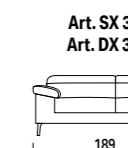
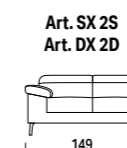
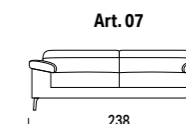
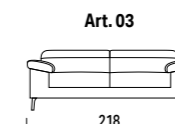
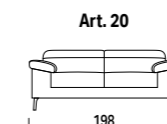
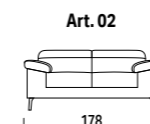
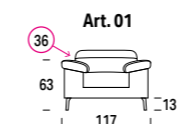
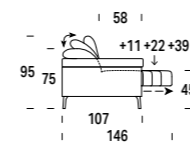

ESEMPI COMPOSITIVI / COMPOSITION EXAMPLES / EXEMPLES DE COMPOSITION / KOMPOSITORISCHE BEISPIELE

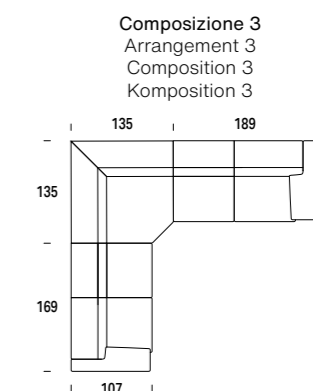
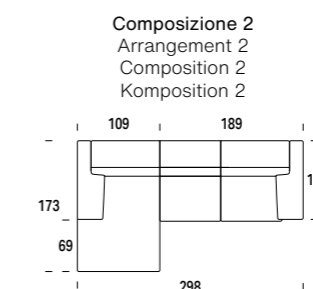
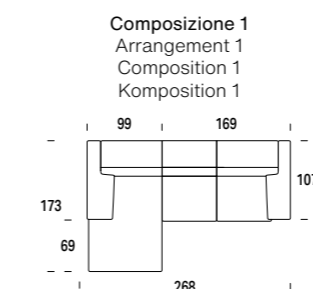

Angel

COMPLETAMENTE SFODERABILE / COMPLETELY REMOVABLE FABRIC COMPLÈTEMENT DÉHOUSSABLE / VOLLSTÄNDIG ENTFERNBAR

STRUTTURA

Realizzata con masselli portanti in legno massiccio di abete in vari spessori. Fianchi e parti strutturali in multistrato di abete o pino da 18 mm, parti di tamponamento in agglomerato di legno di spessore 18 mm e 4 mm. Il tutto in classe E1, pertanto a bassa emissione di formaldeide. Il telaio è completamente rivestito con vellutino 100% poliammine termo accoppiato ad espanso 100% poliestere e/o ovatta resinata da 200 gr di 100% poliestere.

FRAME

Made with bearing parts in solid fir wood in various thicknesses. 18mm fir or pine plywood sides and structural parts, 18 mm and 4 mm thick particle wood infill parts. All treated naturally in Class E1, thus with low formaldehyde emissions. The frame is completely covered with 100% polyamines velveteen thermo coupled with 100% polyester foam and/or 200 g. 100% polyester wadding resin.

STRUCTURE

Réalisée avec des éléments porteurs en bois massif de sapin de différentes épaisseurs. Panneaux latéraux et éléments structuraux en bois de sapin stratifié de 18 mm, élément de remplissage en agglomérat de bois de 18 mm et 4 mm. Le tout traité au naturel en classe E1, soit à faible émission de formaldéhydes. Le cadre est entièrement recouvert de velours 100% polyamines couplé à chaud avec de la résine expansée 100% polyéther et/ou ouate de 200 g 100% polyester.

KORPUS

Wird aus tragenden Elementen aus massivem Tannenholz in verschiedenen Stärken hergestellt. Seiten und Konstruktionsteile aus 18 mm starkem Fichten- oder Kiefernsperrholz, Füllungsteile aus 18 mm und 4 mm starkem Spanholz. Alles entspricht der Klasse E1, also mit geringer Formaldehydabgabe. Der Rahmen ist komplett mit 100% Polyamid-Samt bezogen, der auf 100% Polyesterschaum und/oder gehärteter Watte zu 200g aus 100% Polyester heiß aufkaschiert ist.

IMBOTTITURA

Cuscino seduta in poliuretano espanso flessibile e indeformabile in densità D35 SR rivestito in falda termolegata da 300 gr in poliestere 100%. Cuscino schiena in poliuretano espanso flessibile e indeformabile in densità D18 morbido, rivestito in falda termolegata da 300 gr in 100% poliestere.

PADDING

Flexible and non-deformable polyurethane foam seat cushion, density D35 SR, coated with 300 gr layer-bonded 100% polyester. Flexible and non-deformable polyurethane foam back cushion, density D18 soft, coated with 300 gr layer-bonded 100% polyester.

REMOURRAGE

Coussin d'assise en mousse de polyuréthane souple et indéformable densité D35 SR revêtu en couche collée de 300 g 100% polyester. Coussin de dossier en mousse de polyuréthane souple et indéformable densité D18 moelleux, revêtu en couche collée de 300 g 100% polyester.

POLSTERUNG

Sitzkissen aus elastischem, formstabilem Polyurethan-Schaumstoff in der Dichte D35 SR, verkleidet mit einer wärmegebundenen Schicht zu 300g aus 100% Polyester. Rückenkissen aus elastischem, formstabilem Polyurethan-Schaumstoff in der Dichte D18 weich, verkleidet mit einer wärmegebundenen Schicht zu 300 g aus 100% Polyester.

MOLLEGGIO

Il molleggio è realizzato in nastri da 80 mm tesi meccanicamente, composta da fili di nylon avvolto a spirale.

SPRINGING

Made of 80 mm wide mechanically tensioned webbing composed of nylon strands wound into a spiral.

RESSORTS

Réalisée avec des bandes élastiques de 80 mm tendues mécaniquement, composées par des fils de nylon enroulé à spirale.

FEDERUNG

Die Federung besteht aus 80 mm langen, mechanisch gespannten Gurten aus spiralförmig gewickeltem Nylonfaden.

PIEDI

Piedini in metallo a "slitta" modello ICE. Piedini in rovere naturale, verniciato tabacco e grigio a poro aperto, assemblati a piastra in acciaio zincato modello BAOBAB.

FEET

Metal "sled" feet ICE model. Natural oak feet painted tobacco and open pore grey, galvanised steel plate assembly BAOBAB model.

PIEDS

Petits pieds en métal à "glisse" modèle ICE. Petits pieds en chêne naturel, vernis tabac et gris à pore ouvert, assemblés en plaque en acier galvanisé modèle BAOBAB.

FÜSSE

Metallfüsse im „Schlittenstil“, Modell ICE. Füsse in Eiche Natur, tabakfarben und offenporen grau lackiert, montiert mit verzinkter Stahlplatte Modell BAOBAB.

Barra ICE H.14 / ICE bar H.14 / Barre ICE H.14 / Leiste ICE H14



Carbon look lucido
Shining Carbon look
Carbon look brillant
Carbon-Look Hochglanz

Piede BAOBAB in legno H.14 / BAOBAB wooden feet H. 14
Pied BAOBAB en bois H.14 / Fußmodell BAOBAB aus Holz H14



Rovere Londra
Oak "Londra"
Chêne "Londra"
Eiche "Londra"

Rovere tabacco
Oak "tabacco"
Chêne "tabacco"
Eiche "tabacco"

Rovere naturale
Oak "naturale"
Chêne "naturale"
Eiche "naturale"

Optional poggiatesta / Optional headrest
Option appuie-tête / Optional Kopfstütze

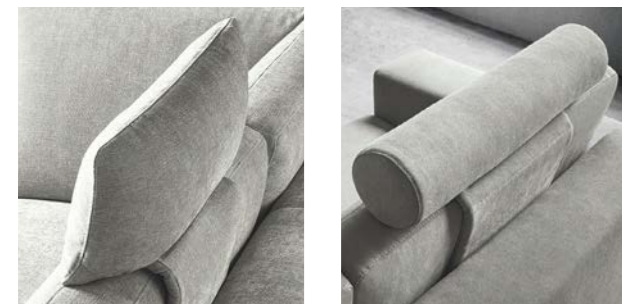

Optional bordo in tinta o contrasto / Optional trim in the same or contrasting colour
Option bord en teinte ou en contraste / Optional Kante Ton-in-Ton oder farblich abgesetzt

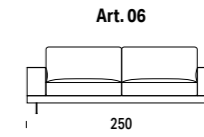
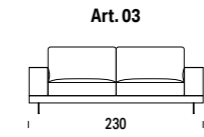
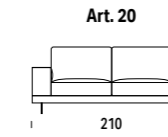
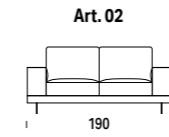
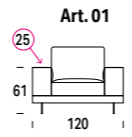
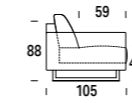

Art. SX SS - Art. DX SD



Art. SX MS - Art. DX MD



Art. SX LS - Art. DX LD



Art. SX BS - Art. DX BD



Art. SX 2S - Art. DX 2D

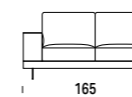

Art. SX GS - Art. DX GD

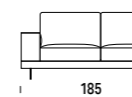

Art. SX 3S - Art. DX 3D

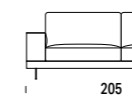

Art. SX 6S - Art. DX 6D

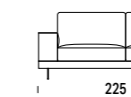

Art. SX CS - Art. DX CD

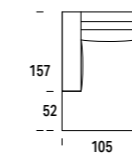

Art. SX LC - Art. DX CL

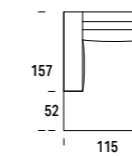

Art. SX BC - Art. DX CB



Art. SX MI - Art. DX IM

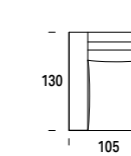

Art. SX LI - Art. DX IL

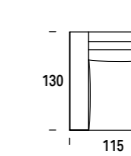

Art. SX BI - Art. DX IB

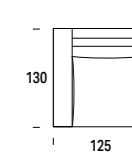

Art. SX PT - Art. DX TP

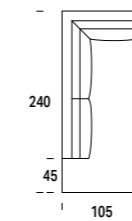

Art. SX TL - Art. DX LT

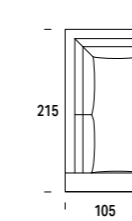

Art. AQ

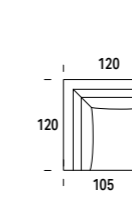

Art. 90

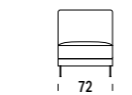

Art. 91

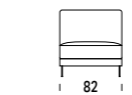

Art. 92

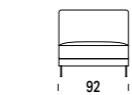

Art. 93

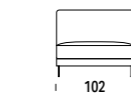

Art. 11

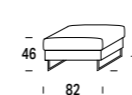

Art. 12

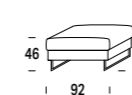

Art. 13

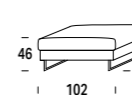

Art. 14

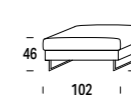

Art. 30

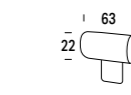

Art. 31

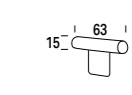

ESEMPI COMPOSITIVI / COMPOSITION EXAMPLES / EXEMPLES DE COMPOSITION / KOMPOSITORISCHE BEISPIELE

Composizione 1
Arrangement 1
Composition 1
Komposition 1

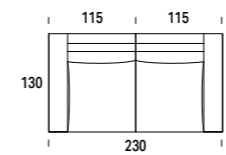

Composizione 2
Arrangement 2
Composition 2
Komposition 2

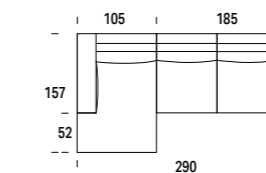

Composizione 3
Arrangement 3
Composition 3
Komposition 3

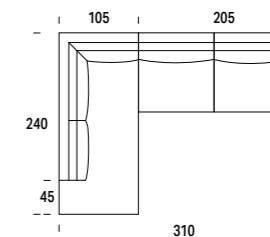

Clair - Wendy - Lizzie

COMPLETAMENTE SFODERABILE / COMPLETELY REMOVABLE FABRIC COMPLÈTEMENT DÉHOUSSABLE / VOLLSTÄNDIG ENTFERNBAR

STRUTTURA

Realizzata con masselli portanti in legno di abete massiccio di vari spessori. Parti di tamponamento in fibra grezza e/o compensato. Telaio in multistrato da 18 mm. Fibra grezza e agglomerato di legno in classe E1, pertanto a bassa emissione di formaldeide. I braccioli sono ancorati alla base con baionette. Il telaio è completamente rivestito con resinato da 200g accoppiato a maglina di 100% poliestere.

FRAME

Load-bearing parts made of solid fir in various thicknesses. Reinforcement parts in wood fibre and/or plywood. 18 mm multilayered wooden frame. Low formaldehyde emissions wood fibre and particleboard (Class E1). The armrests are anchored to the base by means of bayonet fittings. The frame is completely covered with 200g resin wadding bonded to 100% polyester jersey.

STRUCTURE

Réalisée avec des loupes portantes en bois de pin massif de différentes épaisseurs. Parties de remplissage en fibre brute et/ou compensé. Châssis contreplaqué de 18 mm. Fibre brute et aggloméré de bois en classe E1, donc à basse émission de formaldéhyde. Les accoudoirs sont ancrés à la base par des baïonnettes. Le châssis est complètement revêtu par 200 g de résiné accouplé à une maille 100% polyester.

KORPUS

Aus massivem Tannenholz in verschiedenen Stärken, Füllungen aus Rohfaser und/ oder Sperrholz. Seiten aus 18 mm Spanplatte. Alles entspricht der Klasse E1, also mit geringer Formaldehydabgabe. Die Armlehnen sind mit Bajonetten an der Basis befestigt. All dies ist mit Samt aus 100% Polyamid bezogen, der mit Schaumstoff und/oder geharztem Material zu 200 g heiß aufkaschiert wurde, der bzw. das wiederum auf Samt aus 100% Polyesterfaser heiß aufkaschiert wurde.

IMBOTTITURA

Tamponi braccioli D25, D30, D40. Seduta D30 HS. Schiena D18 morbido.

UPHOLSTERY

Armrest reinforcement pads D25, D30, D40. Seat D30 HS. Back D18 soft.

REMOUVRAGE

Remplissages des accoudoirs D25, D30, D40. Assise D30 HS. Dossier D18 souple.

POLSTERUNG

Armlehnenpolster D25, D30 und D40. Sitzkissen D30 HS. Rückenkissen D18 weich.

MOLLEGGIO

Realizzato in nastri da 80 mm tesi meccanicamente, composti da fili di nylon avvolti a spirale.

SPRINGS

Made of 80 mm wide mechanically tensioned webbing composed of spirally wound nylon strands.

RESSORTS

Réalisé en bandes de 80 mm tirés mécaniquement, composés par des fils de nylon enroulés en spirale.

FEDERUNG

Besteht aus elastischen, mechanisch gespannten 80 mm breiten Gurten, die aus Gummifäden bestehen, die mit spiralförmig gewickelten Nylonfäden ummantelt sind

PIEDI

Piede in metallo verniciato con polveri epossidiche e dotato di gommino antiscivolo.

FEET

Epoxy powder coated metal feet fitted with non-slip rubber pads.

PIEDS

Pied en métal vernis en poudre époxyde et équipé de caoutchouc antidérapant.

FÜSSE

Fuss aus pulverbeschichtetem Metall mit rutschfestem Gummi.

PRATICITÀ E VELOCITÀ

I rivestimenti sono sfoderabili al 100% per consentire una facile pulizia e manutenzione. I braccioli possono essere sganciati in modo semplice e sicuro.

PRACTICALITY AND SPEED

Covers are 100% removable for ease of cleaning and maintenance. Armrests can be dismantled simply and safely.

PRACTICITÉ ET VITESSE

Les revêtements sont 100% déhoussables afin de permettre un nettoyage et une manutention faciles. Les accoudoirs peuvent se décrocher facilement et en sécurité.

PRAKTISCH UND SCHNELL

Die Bezüge sind zu 100 % abnehmbar, um die Reinigungs- und Pflegearbeiten zu erleichtern. Die Armlehnen lassen sich einfach und sicher abnehmen.

CLAIR

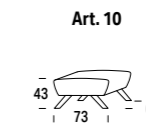
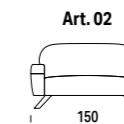
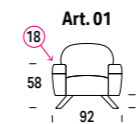
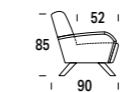

WENDY

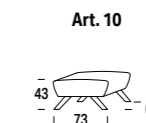
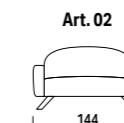
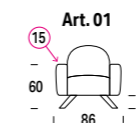
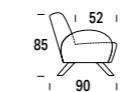

LIZZIE

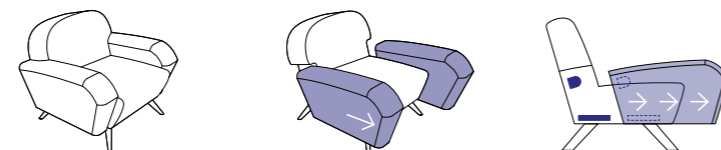
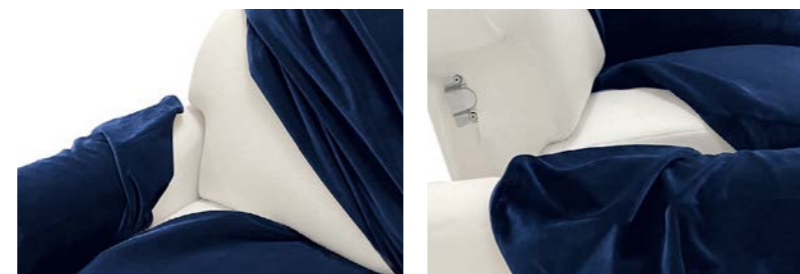
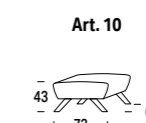
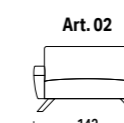
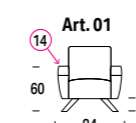
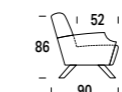

Smontaggio braccioli / Dismantling armrests / Démontage accoudoirs / Demontage der Armlehnen

Capitol

COMPLETAMENTE SFODERABILE / COMPLETELY REMOVABLE FABRIC COMPLÈTEMENT DÉHOUSSABLE / VOLLSTÄNDIG ENTFERNBAR

STRUTTURA

Struttura realizzata con masselli portanti in legno di abete massiccio di vari spessori, parti di tamponamento in fibra grezza e/o compensato. Fianchi in agglomerato di legno e/o multistrato di legno da 18 mm. Fibra grezza e agglomerato di legno in classe E1, pertanto a bassa emissione di formaldeide. Il telaio è rivestito con resinato da 200 gr. termoaccoppiato a vellutino 100% poliestere.

FRAME

Made of solid fir wood in various thicknesses. Reinforcement parts in wood fibre and/or plywood. Sides made of 18 mm particleboard and/or multilayered wood. Wood fibre and particleboard Class E1 therefore low formaldehyde emissions. The frame is covered with 200 gr resinat, thermos-coupled to 100% polyester velveteen.

STRUCTURE

Réalisée en bois massif de sapin portant de différentes épaisseurs. Fileurs de remplissage en fibre brute et/ou contreplaqué. Côtés en aggloméré de bois et/ou multicouches de bois 18 mm. Fibre brute et aggloméré de bois en Classe E1, donc à basse émission de formaldéhydes. Le châssis est revêtu par du velours 100% polyamide couplé à chaud à de l'ouate résinée de 200 gr. 100% polyester.

KORPUS

Aufbau aus massivem Tannenholz in verschiedenen Stärken, Füllungen aus Rohfaser und/oder Sperrholz. Seiten aus 18 mm Spanplatte. Alles entspricht der Klasse E1, also mit geringer Formaldehydabgabe. Der Rahmen ist mit 200 gr Resinat überzogen, das mit 100% Polyester Samt verbinden ist.

IMBOTTITURA

Cuscino seduta in poliuretano espanso indeformabile D35PFFR, il tutto rivestito con falda termolegata da 300 gr. Cuscino schienale ricoperto da imbottitura in pelle d'uovo, cotone poliestere a camere separate riempite al 60% piuma d'oca sterilizzata, 30% espanso bianco e 10% fiocco vergine di poliestere al 100%. Tamponi bracciolo e schiena in espanso indeformabile D25.

REMOURRAGE

Non-deformable polyurethane foam seat cushion D35PFFR, covered in 300 g heat-bound wadding. Seat cushion covered in padding in muslin, cotton polyester with separate chambers filled with 60% sterilised goose down, 30% white foam and 10% pure polyester flock. Armrest and back pads made of D25 non-deformable foam.

REMOURRAGE

Coussin d'assise en mousse de polyuréthane indéformable D35PFFR, recouvert d'un rabat thermolié de 300 g. Coussin de dossier garni de mousseline, coton-polyester avec chambres séparées garnies de 60% de duvet d'oie stérilisé, 30% de mousse blanche et 10% de flocage 100% polyester. Coussinet d'accouoir et dossier en mousse indéformable D25.

REMOURRAGE

Sitzkissen aus unverformbarem Polyurethanschaumstoff D35PFFR, vollständig mit 300 g thermoverbundenem Vlies bezogen. Rückenlehnenkissen mit Musselinbezug und Polsterung aus Polyesterbaumwolle mit getrennten Kammern mit 60 % sterilisierten Gänsedaunen, 30% weißer Schaumstoff und 10% Neukunstbaumwolle aus 100% Polyester gefüllt. Arm - und Rückenkissen aus unverformbarem Schaumstoff D25.

MOLLEGGIO

Il molleggio è realizzato in nastri da 80 mm tesi meccanicamente, composti da fili di nylon avvolto a spirale.

SPRINGING

Made of 80 mm wide mechanically tensioned webbing composed of nylon strands wound into a spiral.

SUSPENSION

Réalisée avec des bandes élastiques de 80 mm tendues mécaniquement, composées par des fils de gomme recouverts par du fil de nylon enroulé à spirale.

FEDERUNG

Hergestellt aus mechanisch gedehnten 80-mmElastikbändern, bestehend aus spiralförmig gewickelten Nylonfäden.

PIEDI

In alluminio pressofuso lucidato meccanicamente con finitura nero opaco H 130 mm.

PIEDS

In mechanically polished die-cast aluminium with matt black finish H 130 mm.

PIEDS

En aluminium moulé sous pression, poli mécaniquement, finition noire mate H 130 mm.

PIEDS

Aus druckgegossenen Aluminium mechanisch glänzend in Mattschwarz lackiert H 130 mm.

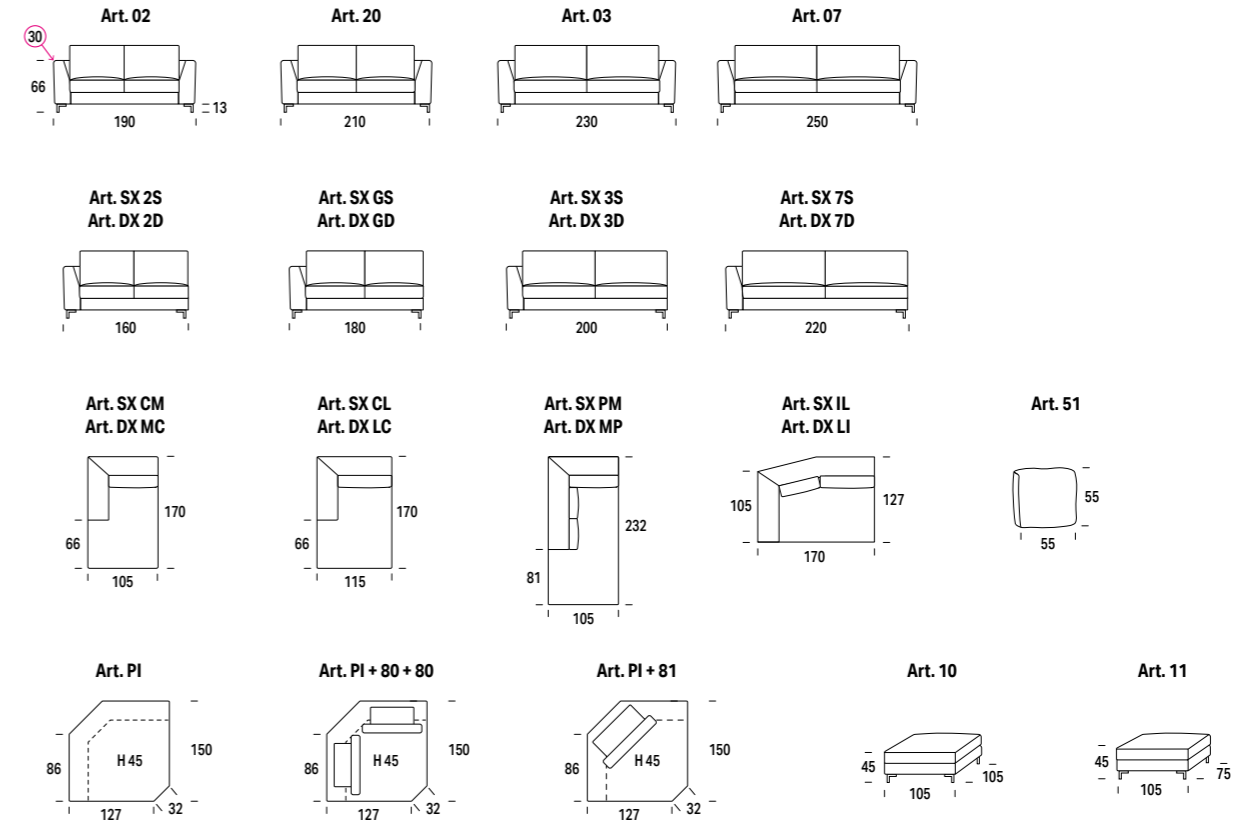
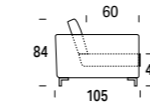
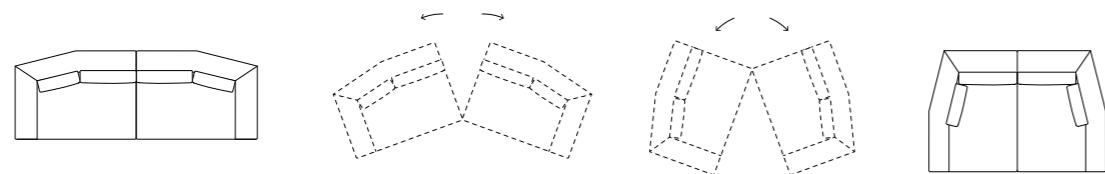

ESEMPI COMPOSITIVI / COMPOSITION EXAMPLES / EXEMPLES DE COMPOSITION / KOMPOSITORISCHE BEISPIELE

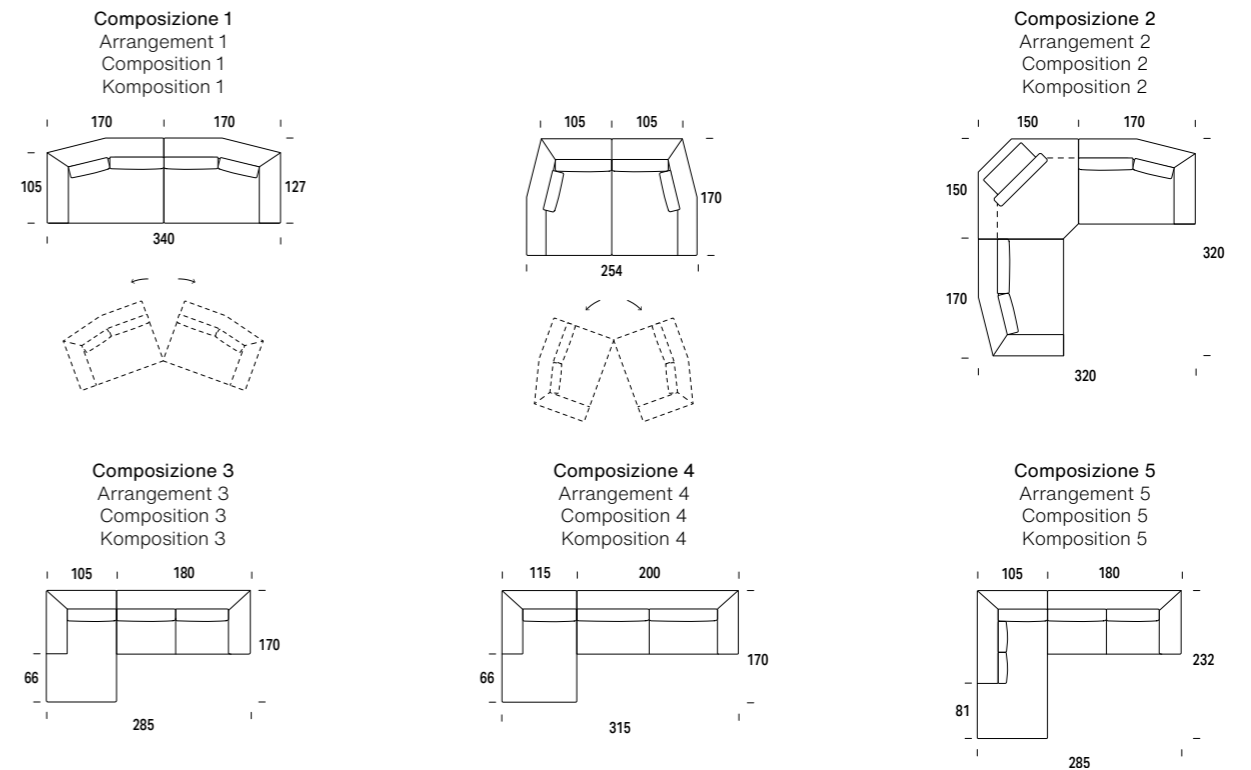

Conrad

COMPLETAMENTE SFODERABILE / COMPLETELY REMOVABLE FABRIC COMPLÈTEMENT DÉHOUSSABLE / VOLLSTÄNDIG ENTFERNBAR

STRUTTURA

Struttura realizzata con masselli portanti in legno di abete massiccio di vari spessori, parti di tamponamento in fibra grezza e/o compensato. Fianchi in agglomerato di legno e/o multistrato di legno da 18 mm. Fibra grezza e agglomerato di legno in classe E1, pertanto a bassa emissione di formaldeide. Il telaio è rivestito con resinato da 200 gr. termoaccoppiato a vellutino 100% poliestere.

FRAME

Made of solid fir wood in various thicknesses. Reinforcement parts in wood fibre and/or plywood. Sides made of 18 mm particleboard and/or multilayered wood. Wood fibre and particleboard Class E1 therefore low formaldehyde emissions. The frame is covered with 200 gr resinat, thermos-coupled to 100% polyester velveteen.

STRUCTURE

Réalisée en bois massif de sapin portant de différentes épaisseurs. Fileurs de remplissage en fibre brute et/ou contreplaqué. Côtés en aggloméré de bois et/ou multicouches de bois 18 mm. Fibre brute et aggloméré de bois en Classe E1, donc à basse émission de formaldéhydes. Le châssis est revêtu par du velours 100% polyamide couplé à chaud à de l'ouate résinée de 200 gr. 100% polyester.

KORPUS

Aufbau aus massivem Tannenholz in verschiedenen Stärken, Füllungen aus Rohfaser und/oder Sperrholz. Seiten aus 18 mm Spanplatte. Alles entspricht der Klasse E1, also mit geringer Formaldehydabgabe. Der Rahmen ist mit 200 gr Resinat überzogen, das mit 100% Polyester Samt verbinden ist.

IMBOTTITURA

Cuscino seduta in poliuretano espanso indeformabile D35SR, il tutto rivestito con falda termolegata da 300 gr. Cuscino schienale ricoperto da imbottitura in pelle d'uovo, cotone poliestere a camere separate riempite al 60% piuma d'oca sterilizzata, 30% espanso bianco e 10% fiocco vergine di poliestere al 100%. Tamponi bracciolo poliuretano espanso indeformabile D35. Tamponi schiena poliuretano espanso indeformabile di diverse densità D30 / D21.

PADDING

Non-deformable polyurethane foam seat cushion D35SR, covered in 300 g heat-bound wadding. Seat cushion covered in padding in muslin, cotton polyester with separate chambers filled with 60% sterilised goose down, 30% white foam and 10% pure polyester flock. Non-deformable polyurethane foam seat cushion D35. Non-deformable polyurethane foam back pad in different densities D30/D21.

REMOURAGE

Coussin d'assise en mousse de polyuréthane indéformable D35SR, recouvert d'un rabat thermolié de 300 g. Coussin de dossier garni de mousseline, coton-polyester avec chambres séparées garnies de 60% de duvet d'oie stérilisé, 30% de mousse blanche et 10% de flocage 100% polyester. Coussinets d'accouoir en mousse de polyuréthane indéformable D35. Coussinets de dossier en mousse de polyuréthane indéformable de différentes densités D30/D21.

POLSTERUNG

Sitzkissen aus unverformbarem Polyurethanschaumstoff D35SR, vollständig mit 300 g thermoverbundenem Vlies bezogen. Rückenlehnenkissen mit Musselinbezug und Polsterung aus Polyesterbaumwolle mit getrennten Kammern mit 60 % sterilisierten Gänsedaunen, 30% weißer Schaumstoff und 10% Neukunstbaumwolle aus 100% Polyester gefüllt. Armkissen aus unverformbarem Polyesterschaumstoff D35. Rückenkissen aus unverformbarem Polyesterschaumstoff unterschiedlicher Dichte D30 / D21.

MOLLEGGIO

Il molleggio è realizzato in nastri da 80 mm tesi meccanicamente, composti da fili di nylon avvolto a spirale.

SPRINGING

Made of 80 mm wide mechanically tensioned webbing composed of nylon strands wound into a spiral.

SUSPENSION

Réalisée avec des bandes élastiques de 80 mm tendues mécaniquement, composées par des fi ls de gomme recouverts par du fi l de nylon enroulé à spirale.

FEDERUNG

Hergestellt aus mechanisch gedehnten 80-mmElastikbändern, bestehend aus spiralförmig gewickelten Nylonfäden.

PIEDI

Piedi in metallo H 120 mm con finitura carbon look, disponibile nella versione stiletto classico o stiletto con base Ray Circle (optional). Completo di gommini antiscivolo. Barra in metallo H 120 mm con finitura grigio antracite. Completa di gommini antiscivolo.

FEET

Metal feet H 120mm with carbon look finish, available in the classic stiletto or stiletto with Ray Circle base version (optional). Including non-slip rubber pads. Metal bar H 120 mm with anthracite grey finish. Including non-slip rubber pads.

PIEDS

Pieds en métal H 120 mm avec finition aspect carbone, disponibles en version stiletto classique ou stiletto avec base Ray Circle (en option). Fourni avec des tampons antidérapants en caoutchouc. Barre métallique H 120 mm avec finition gris anthracite. Et tampons antidérapants en caoutchouc.

FÜSSE

Metallbein H 120 mm mit Oberflächenbearbeitung in Carbon Look, erhältlich in der Version Klassisches Stilett oder Stilett mit Ray-Circle-Sockel (optional). Komplett mit Gummistopper. Metallstange H 120 mm mit Oberflächenausführung in Anthrazitgrau. Komplett mit Gummistopper.



RAY STANDARD



RAY CIRCLE OPTIONAL



STYLE OPTIONAL

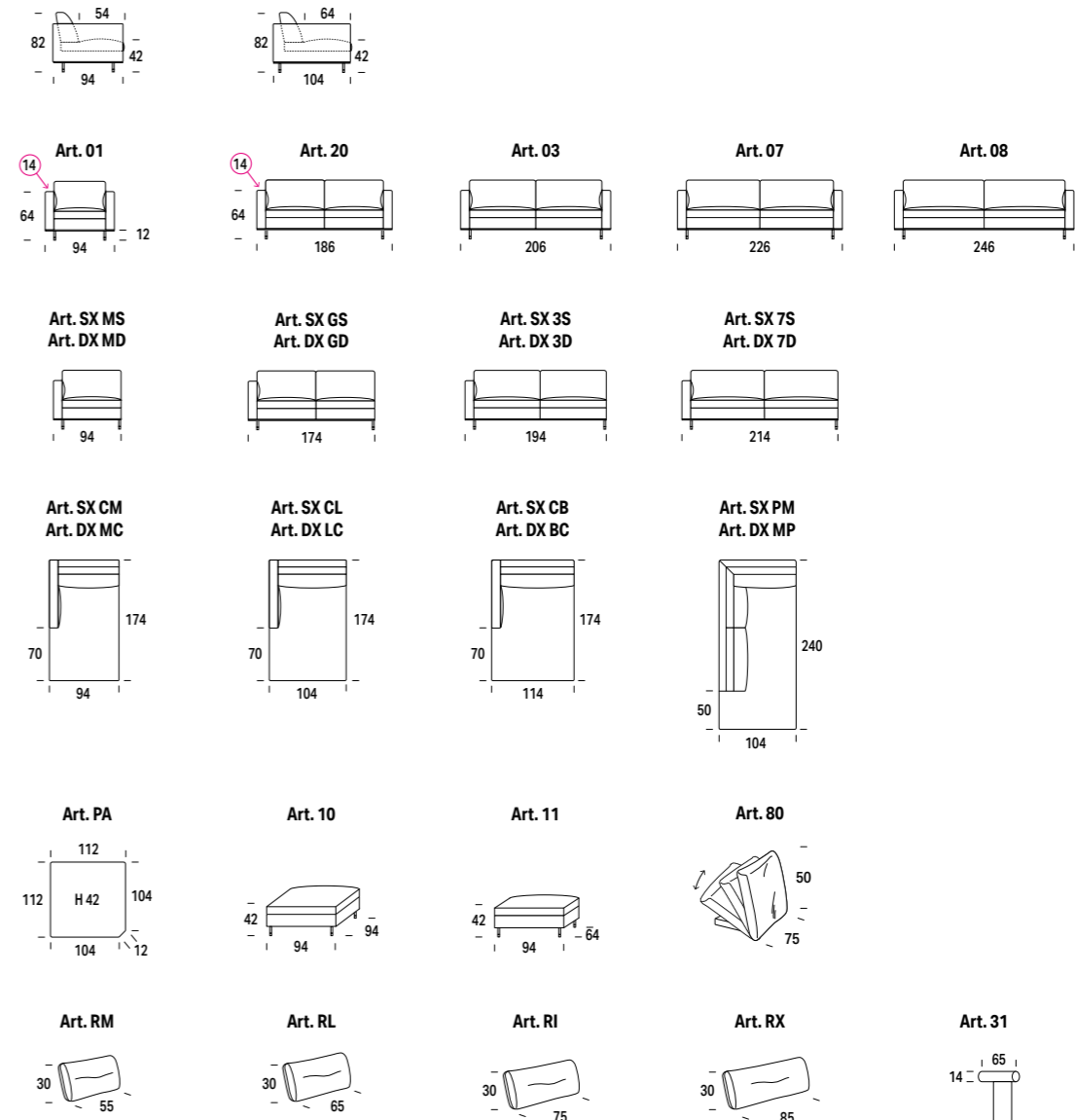

ESEMPI COMPOSITIVI / COMPOSITION EXAMPLES / EXEMPLES DE COMPOSITION / KOMPOSITORISCHE BEISPIELE

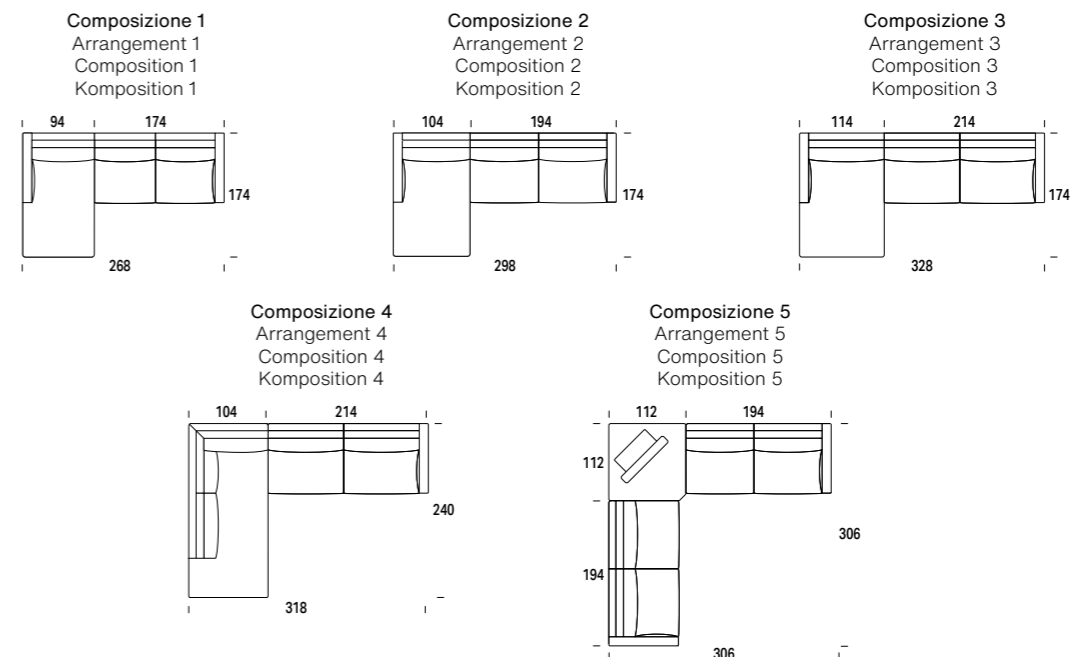

Flamingo

COMPLETAMENTE SFODERABILE / COMPLETELY REMOVABLE FABRIC COMPLÈTEMENT DÉHOUSSABLE / VOLLSTÄNDIG ENTFERNBAR

BROWN EMPERADOR

- Peso volumetrico 2,720 Kg/m³
- Resistenza a compressione 1126 Kg/cm²
- Resistenza a flessione 106 Kg/cm²
- Resistenza ad abrasione 0,55 mm
- Imbibizione 0,31% per peso

BROWN EMPERADOR

- Bulk density 2,720 Kg/m³
- Compressive strength 1126 Kg/cm²
- Flexural strength 106 Kg/cm²
- Abrasion resistance 0,55 mm
- Absorption 0,31 % per weight

BROWN EMPERADOR

- Poids volumétrique 2,720 Kg/m³
- Résistance à la compression 1126 Kg/cm²
- Résistance à la flexion 106 Kg/cm²
- Résistance à l'abrasion 0,55 mm
- Absorption 0,31% par poids

BROWN EMPERADOR

- Raumgewicht 2,720 kg/m³
- Druckfestigkeit 1126 kg/cm²
- Biegefestigkeit 106 kg/cm²
- Abriebfestigkeit 0,55 mm
- Imprägnierung 0,31 Gew.%

CARRARA

- Peso volumetrico 2742 Kg/m³
- Resistenza a compressione 1298 Kg/cm²
- Resistenza a flessione 207 Kg/cm²
- Resistenza ad abrasione 0,64 mm
- Imbibizione 0,15% per peso
- Coeff. di dilatazione termica 0,0073 mm./m.

CARRARA

- Bulk density 2742 Kg/m³
- Compressive strength 1298 Kg/cm²
- Flexural strength 207 Kg/cm²
- Abrasion resistance 0,64 mm
- Absorption 0,15% per weight
- Thermal expansion coefficient 0,0073 mm./m.

CARRARA

- Poids volumétrique 2742 Kg/m³
- Résistance à la compression 1298 Kg/cm²
- Résistance à la flexion 207 Kg/cm²
- Résistance à l'abrasion 0,64 mm
- Absorption 0,15% par poids
- Coeff. de dilatation thermique 0,0073 mm./m.

CARRARA

- Raumgewicht 2742 kg/m³
- Druckfestigkeit 1298 kg/cm²
- Biegefestigkeit 207 kg/cm²
- Abriebfestigkeit 0,64 mm
- Imprägnierung 0,15 Gew.%
- Wärmeausdehnungskoeffizient 0,0073 mm/m

LE SOSTANZE E I PRODOTTI DA EVITARE

Per la pulizia del marmo dovrete evitare tutte le sostanze acide che invece possono risultare utili per le pulizie ecologiche di altre parti della casa. Per il marmo non dovrete utilizzare succo di limone, acido citrico, aceto di vino o aceto di mele, detersivi aggressivi ed altre soluzioni che risultino acide o corrosive, dato che il marmo è molto delicato. Evitate i prodotti abrasivi e tutti gli strumenti che potrebbero graffiare il marmo e rovinarlo in modo irrimediabile.

SUBSTANCES AND PRODUCTS TO AVOID

When cleaning marble, avoid acidic substances, which, on the other hand, may be useful for the ecological cleaning of other parts of the house. Lemon juice, citric acid, vinegar or apple cider vinegar, strong detergents and other solutions that are acidic or corrosive should never be used on marble, because it is very delicate. Avoid abrasive cleaners and tools that could scratch the marble and ruin it beyond repair.

SUBSTANCES ET PRODUITS À ÉVITER

Pour nettoyer le marbre, toujours éviter les substances acides lesquelles peuvent cependant être utilisées pour le nettoyage écologique d'autres parties de la maison. Pour le marbre, ne pas utiliser de jus de citron, acide citrique, vinaigre de vin ou de pomme, détergents agressifs et autres solutions acides ou corrosives, car le marbre est très délicat. Éviter les produits abrasifs et tous les outils susceptibles de rayer le marbre ou de l'abîmer de façon irrémédiable.

ZU VERMEIDENDE SUBSTANZEN UND PRODUKTE

Bei der Reinigung von Marmor sollten Sie alle säurehaltigen Substanzen vermeiden, die für eine umweltfreundliche Reinigung anderer Artikel in der Wohnung nützlich sein können. Für Marmor sollten Sie keinen Zitronensaft, keine Zitronensäure, keinen Wein- oder Apfelessig, keine aggressiven Reinigungsmittel und keine anderen säurehaltigen oder ätzenden Lösungen verwenden, da Marmor sehr empfindlich ist. Vermeiden Sie außerdem Scheuermittel und alle Gegenstände, die den Marmor zerkratzen und unwiederbringlich ruinieren könnten.

FINITURE PIANO / TOP FINISHES

FINITIONS PLATEAU / AUSFÜHRUNG DER PLATTE



CARRARA



BROWN EMPERADOR

FINITURE GAMBE / LEG FINISHES

FINITIONS PIEDS / AUSFÜHRUNG DER FÜSSE



Cromo
Chrome
Chrome
Chrom

Oro
Gold
Or
Gold

Rame
Copper
Cuivre
Kupfer

Carbon look lucido
Shining carbon look
Look carbone brillant
Carbon - Look Hochglanz

H. 30/43

Art. 10 CARRARA

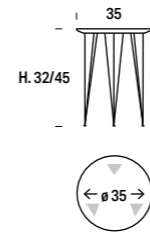

Piano rotondo ø 35 cm / 3 gambe
Round top ø 35 cm / 3 legs
Plateau rond ø 35 cm / 3 pieds
Runden Platte ø 35 cm / 3 Füße



Gambe cromo
Cromo legs
Pieds chromés
Chrom Füße



Gambe oro
Gold legs
Pieds or
Gold Füße



Gambe carbon look
Carbon look legs
Pieds look carbone
Carbon-Look Füße



Gambe rame
Copper legs
Pieds cuivre
Kupfer Füße

Art. 12 CARRARA

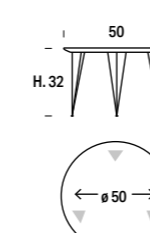

Piano rotondo ø 50 cm / 3 gambe
Round top ø 50 cm / 3 legs
Plateau rond ø 50 cm / 3 pieds
Runden Platte ø 50 cm / 3 Füße



Gambe cromo
Cromo legs
Pieds chromés
Chrom Füße



Gambe oro
Gold legs
Pieds or
Gold Füße



Gambe carbon look
Carbon look legs
Pieds look carbone
Carbon-Look Füße



Gambe rame
Copper legs
Pieds cuivre
Kupfer Füße

Art. 14 CARRARA

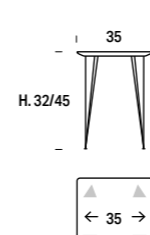

Piano quadrato L 35 cm / 4 gambe
Square top L 35 cm / 4 legs
Plateau carré L 35 cm / 4 pieds
Quadratische Platte B 35 cm / 4 Füße



Gambe cromo
Cromo legs
Pieds chromés
Chrom Füße



Gambe oro
Gold legs
Pieds or
Gold Füße



Gambe carbon look
Carbon look legs
Pieds look carbone
Carbon-Look Füße



Gambe rame
Copper legs
Pieds cuivre
Kupfer Füße

Art. 16 CARRARA

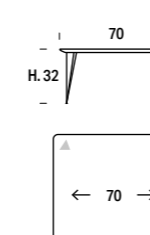

Piano quadrato L 70 cm / 4 gambe
Square top L 70 cm / 4 legs
Plateau carré L 70 cm / 4 pieds
Quadratische Platte B 70 cm / 4 Füße



Gambe cromo
Cromo legs
Pieds chromés
Chrom Füße



Gambe oro
Gold legs
Pieds or
Gold Füße



Gambe carbon look
Carbon look legs
Pieds look carbone
Carbon-Look Füße



Gambe rame
Copper legs
Pieds cuivre
Kupfer Füße

Art. 18 CARRARA

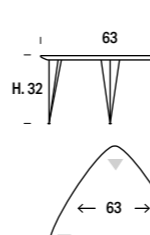

Piano triangolare L 63 cm / 3 gambe
Triangular top L 63 cm / 3 legs
Plateau triangulaire L 63 cm / 3 pieds
Dreieckige Platte B 63 cm / 3 Füße



Gambe cromo
Cromo legs
Pieds chromés
Chrom Füße



Gambe oro
Gold legs
Pieds or
Gold Füße



Gambe carbon look
Carbon look legs
Pieds look carbone
Carbon-Look Füße



Gambe rame
Copper legs
Pieds cuivre
Kupfer Füße

Float

COMPLETAMENTE SFODERABILE / COMPLETELY REMOVABLE FABRIC COMPLÈTEMENT DÉHOUSSABLE / VOLLSTÄNDIG ENTFERNBAR

STRUTTURA

Struttura realizzata con masselli portanti in legno di abete massiccio di vari spessori, parti di tamponamento in fibra grezza e/o compensato.

Fianchi in agglomerato di legno e/o multistrato di legno da 18 mm. Fibra grezza e agglomerato di legno in classe E1, pertanto a bassa emissione di formaldeide. Il telaio è rivestito con resinato da 200 gr. termoaccoppiato a vellutino 100% poliestere.

IMBOTTITURA

Seduta in poliuretano espanso indeformabile D35 SR. Schienale e braccioli in espanso indeformabile D18 SS.

MOLLEGGIO

Realizzato con nastri elastici da 80 mm tesi meccanicamente, composti da fili di nylon avvolti a spirale.

PIEDI

Piedi in ABS nero da H 40 mm, non visibili.

FRAME

Made of solid fir wood in various thicknesses. Reinforcement parts in wood fibre and/or plywood.

Sides made of 18 mm particleboard and/or multi-layered wood. Wood fibre and particleboard Class E1 therefore low formaldehyde emissions. The frame is upholstered with 100% polyamide velveteen thermo-bonded to 200 g 100% polyester resin wadding.

PADDING

Seat made of non-deformable polyurethane foam D35 SR. Backrest and armrests made of flexible foam D18 SS.

SPRINGING

Made of 80 mm wide mechanically tensioned webbing composed of nylon strands wound into a spiral.

FEET

Black ABS plastic feet H 40 mm, not visible.

STRUCTURE

Réalisée en bois massif de pin portant de différentes épaisseurs. Fileurs de remplissage en fibre brute et/ou contreplaqué. Côtés en aggloméré de bois et/ou multicouches de bois 18 mm.

Fibre brute et aggloméré de bois en Classe E1, donc à basse émission de formaldéhydes. Le châssis est revêtu par du velours 100% polyamide couplé à chaud à de l'ouate résinée de 200 gr. 100% polyester.

REMBOURRAGE

Assise en expansé indéformable de polyuréthane D35 SR. Dossier et accoudoirs en expansé flexible et indéformable de polyuréthane D18 SS.

SUSPENSION

Réalisée avec des bandes élastiques de 80 mm tendues mécaniquement, composées par des fils de gomme recouverts par du fil de nylon enroulé à spirale.

PIEDS

Pieds en ABS noir H. 40 mm, non visibles.

KORPUS

Aus massivem Tannenholz in verschiedenen Stärken, Füllungen aus Rohfaser und/oder Sperrholz. Seiten aus 18 mm Spanplatte. Alles entspricht der Klasse E1, also mit geringer Formaldehydabgabe.

All dies ist mit Samt aus 100% Polyamid bezogen, der mit Schaumstoff und/oder geharztem Material zu 200 g heiß aufkaschiert wurde, der bzw. Das wiederum auf Samt aus 100% Polyesterfaser heiß aufkaschiert wurde.

POLSTERUNG

Sofasitz aus formstabilem Polyurethanschaum D35 SR. Rücklehne und armlehnen Polyurethanschaum D18 SS.

FEDERUNG

Besteht aus elastischen, mechanisch gespannten 80mm breiten Gurten, die aus Gummifäden bestehen, die mit spiralförmig gewickelten Nylonfäden ummantelt sind.

FÜSSE

40 mm hohe Füße aus nicht sichtbarem ABS in Schwarz.

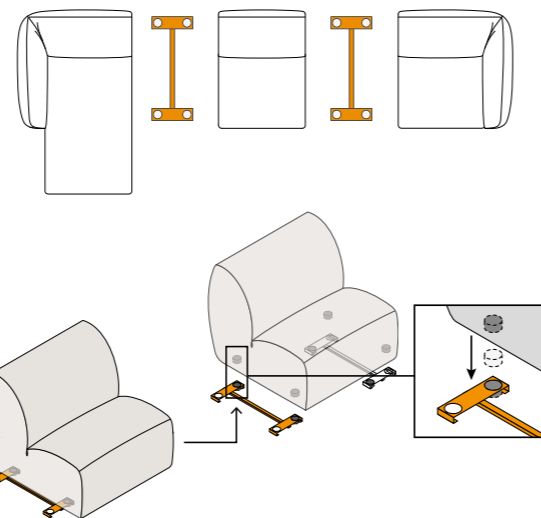
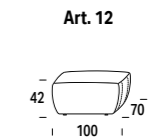
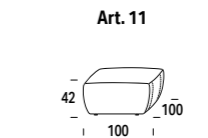
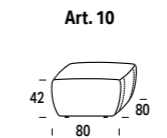
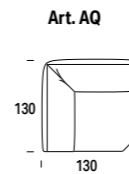
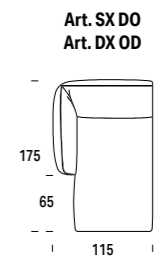
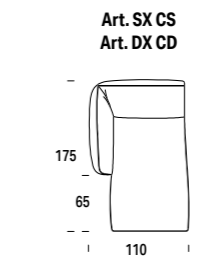
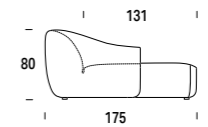
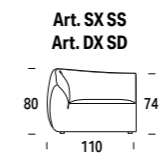
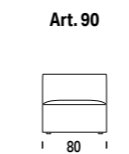
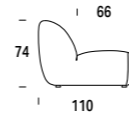
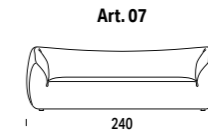
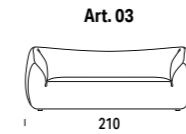
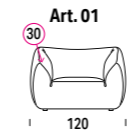
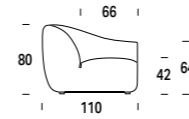

ESEMPI COMPOSITIVI / COMPOSITION EXAMPLES / EXEMPLES DE COMPOSITION / KOMPOSITORISCHE BEISPIELE

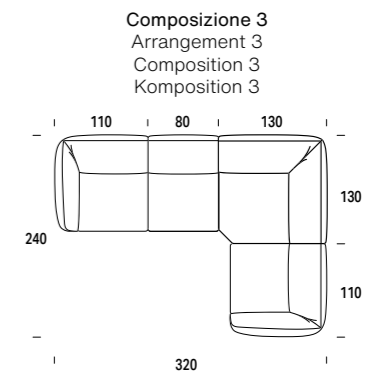
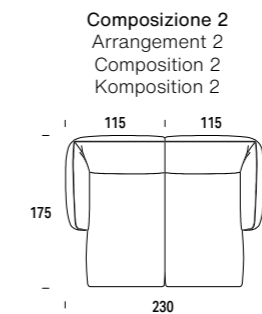
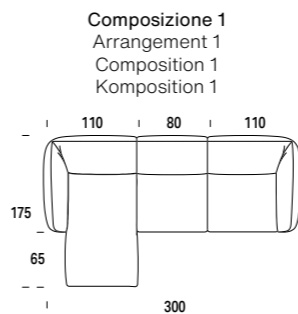

Glove

COMPLETAMENTE SFODERABILE / COMPLETELY REMOVABLE FABRIC COMPLÈTEMENT DÉHOUSSABLE / VOLLSTÄNDIG ENTFERNBAR

STRUTTURA

Realizzata con masselli portanti in legno di abete massiccio di vari spessori, parti di tamponamento in fibra grezza e/o compensato di legno. Struttura in agglomerato di legno e/o multistrato da 18 mm. Il tutto è in classe E1, pertanto a bassa emissione di formaldeide. Il tutto ricoperto con vellutino 100% poliammide accoppiato ad espanso e/o resinato da 200 gr. accoppiato a maglina 100% poliestere.

IMBOTTITURA

Cuscino seduta in espanso indeformabile D35.SE ricoperto con resinato da 200 gr. Accoppiato a maglina 100% poliestere. Cuscino schienale e poggiatesta in espanso indeformabile D16 morbido ricoperto con resinato da 200 gr. accoppiato a maglina 100% poliestere termofissato a vellutino. Bracciolo in espanso indeformabile in D30 - D21 con falda da 300 gr. termolegata. Il tutto ricoperto con resinato 200 gr. accoppiato a maglina 100% poliestere.

MOLLEGGIO

Realizzato in nastri da 80 mm tesi meccanicamente, composti da fili in nylon avvolto a spirale.

PIEDI

Piedi in ABS nero H40 mm non visibile.

FRAME

Construction features load-bearing frames in solid fir wood of various thicknesses, reinforcement parts made of rough fibre and/or plywood. Structure made of 18 mm chipboard and/or 18 mm multi-layered wood. All Class E1, therefore low formaldehyde emissions. Completely covered with 100% polyamide velveteen bonded to 200 g foam and/or resin bonded to 100% polyester jersey.

UPHOLSTERY

Seat cushion made of D35.SE nondeformable foam covered with 200g resin bonded to 100% polyester jersey. Back cushion and headrest made of soft D16 non-deformable foam covered with 200g resin bonded to 100% polyester jersey thermo-fixed to velveteen. Armrest made of D30 - D21 non deformable foam with 300 g thermo-bonded lap. Completely covered with 200 g resin bonded to 100% polyester jersey.

SPRINGS

Mechanically tensioned 80 mm wide bands, composed of spiral-wound nylon strands.

FEET

H40 mm ABS plastic feet, not visible.

STRUCTURE

Réalisée en bois de pin massif portant de différentes épaisseurs, les parties de remplissage sont en fibre brute et/ou en bois compensé. Structure en bois aggloméré et / ou en multicouches de 18 mm. Le tout en classe E1, avec une basse émission de formaldéhyde. Tout est recouvert de velours 100% polyamide accouplé à 200 gr. d'expansé et/ou de résiné accouplé à une maille 100% polyester.

REMBOURRAGE

Coussin d'assise en expansé indéformable D35.SE recouvert par un résiné de 200 gr. accouplé à une maille 100% polyester. Coussin dossier et appuie-tête en expansé indéformable D16 souple recouvert par un résiné de 200 gr. accouplé à une maille 100% velours polyester fixée par chaleur. Accoudoirs en expansé indéformable en D30-D21 avec couverture de 300 gr. attachée par chaleur. Le tout recouvert avec un résiné de 200 gr. accouplé à une maille 100% polyester.

RESSORTS

Réalisés en bandes de 80 mm. tendus mécaniquement, composés par des fils en nylon enroulés à spirale.

PIEDS

Pieds en ABS noir H. 40 mm invisibles.

KORPUS

Aus massivem Tannenholz in verschiedenen Stärken, Füllungen aus Rohfaser und/ oder Sperrholz. Seiten aus 18 mm Spanplatte. Alles entspricht der Klasse E1, also mit geringer Formaldehydabgabe. All dies ist mit Samt aus 100% Polyamid bezogen, der mit Schaumstoff und/oder geharztem Material zu 200 g heiß aufkaschiert wurde, der bzw. das wiederum auf Samt aus 100% Polyesterfaser heiß aufkaschiert wurde.

POLSTERUNG

Sitzkissen aus unverformbarem Schaumstoff D35 SE mit 200 g Harz bezogen. gepaart mit 100% Polyester Pullover. Rückenkissen und Kopfstütze aus unverformbarem Schaumstoff D16 weich bezogen mit 200 gr Harz. gepaart mit 100% Polyester Pullover thermofixiertem Samt. Armlehne aus unverformbarem Schaumstoff aus D30 - D21 mit 300 gr Klappe. thermogebunden. Alles mit Harz 200 gr bedeckt. gepaart mit 100% Polyester Pullover.

FEDERUNG

Besteht aus elastischen, mechanisch gespannten 80mm breiten Gurten, die aus Gummifäden bestehen, die mit spiralförmig gewickelten Nylonfäden ummantelt sind.

FÜSSE

40 mm hohe Füße aus nicht sichtbarem ABS in Schwarz.

DISPONIBILE IN VERSIONE FISSA O ELETTRICA
AVAILABLE AS FIXED OR ELECTRIC VERSIONS
DISPONIBILE EN VERSION FIXE OU ÉLECTRIQUE
ERHÄLTlich IN FESTSTEHENDER ODER ELEKTRISCH VERSTELLBARER AUSFÜHRUNG



VERSIONE FISSA

Con poggiatesta manuale dotato di meccanica a cricchetto.

FIXED VERSION

Featuring manual headrest fitted with ratchet mechanism.

VERSION FIXE

Avec appuie-tête manuel doté de mécanisme à cliquet.

FESTSTEHENDE VERSION

Mit manueller Kopfstütze und Ratschenmechanismus.



DISPONIBILE IN VERSIONE MANUALE OPPURE ELETTRICA, CONSULTARE IL LISTINO PER LE POSSIBILI SOLUZIONI.
AVAILABLE IN MANUAL OR ELECTRIC VERSION, CONSULT THE PRICE LIST FOR ALL POSSIBLE SOLUTIONS.
DISPONIBILE EN VERSION MANUELLE OU ÉLECTRIQUE, CONSULTEZ LA LISTE DE PRIX POUR TOUTES LES POSSIBLES SOLUTIONS.
VERFÜGBAR IN MANUELLER ODER ELEKTRISCHER VERSION, KONSULTIEREN SIE DIE PREISLISTE FÜR MÖGLICHE LÖSUNGEN.



VERSIONE ELETTRICA

Con doppia motorizzazione (seduta e poggiatesta).

ELECTRIC VERSION

Features dual motorisation (seat and headrest).

VERSION ÉLECTRIQUE

Avec double motorisation (assise et appuie-tête).

ELEKTRISCH VERSTELLBARE VERSION

Mit doppelter Motorisierung (Sitzfläche und Kopfstütze).



Glove

Il pratico telecomando aziona due motori elettrici in modo indipendente per regolare poggiatesta e/o seduta. Grazie al meccanismo Zero Wall, si può scegliere l'inclinazione preferita senza allontanare il divano dal muro.

The practical remote control drives two electric motors, which independently adjust the headrest and/or seat. The Zero Wall mechanism enables you to choose your favourite reclining position without moving the sofa away from the wall.

Le télécommande pratique actionne deux moteurs électriques de façon indépendante afin de régler appui-tête et/ou assise. Grâce au mécanisme Zero Wall, vous pouvez choisir l'inclinaison préférée sans devoir éloigner le canapé du mur.

Die praktische Fernbedienung steuert zwei Elektromotoren unabhängig voneinander zur Verstellung von Kopfstütze und/oder Sitz. Dank des Zero-Wall-Mechanismus können Sie Ihre bevorzugte Neigung einstellen, ohne das Sofa von der Wand abrücken zu müssen.

Nel caso in cui si opti per una seduta fissa insieme a una elettrica, è necessario specificare la posizione di quest'ultima (dx/sx).

If you opt for a section featuring both fixed and electric seat, please specify the position of the electric seat (right or left).

Dans le cas où vous optiez pour une assise fixe associée à une électrique, il est nécessaire de spécifier la position de cette dernière (d./g.).

Wenn Sie sich für einen feststehenden und einen elektrisch verstellbaren Sitz entscheiden, müssen Sie die Position des letzteren angeben (rechts/links).



CARTER DI COPERTURA FORNITO DI SERIE
COVERING CARTER SUPPLIED AS STANDARD
CARTER DE COUVERTURE FOURNI EN STANDARD
STANDARDMÄSSIGE ABDECKUNG

SFODERABILE AL 100%
I rivestimenti sono completamente sfoderabili per consentire pulizia e manutenzione con la massima praticità.

100% REMOVABLE COVERS
The covers are all removable to ensure highly practical cleaning and maintenance.

100% DÉHOUSSABLE
Les revêtements sont complètement déhoussables afin de permettre un nettoyage et une manutention très pratique.

ZU 100% ABNEHMBARE BEZÜGE
Die Bezüge sind vollständig abnehmbar, um die Reinigungs- und Pflegearbeiten zu erleichtern.



SALVAMONETE

Anche quando il divano si inclina, nessun oggetto può finire all'interno della struttura grazie a un tessuto di collegamento tra seduta e schienale.

SAUVE MONNAIE

Même lorsque le canapé s'incline, aucun objet ne peut finir à l'intérieur de la structure grâce au tissu de liaison entre l'assise et le dossier.

COIN SAVER

Even when the sofa is reclining, no object can get into the frame as a layer of fabric connects the seat to the backrest.

MÜNZAUFFANG

Selbst wenn das Sofa geneigt wird, können dank einer Stoffverbindung zwischen Sitz und Rückenlehne keine Gegenstände in das Innere der Struktur gelangen.

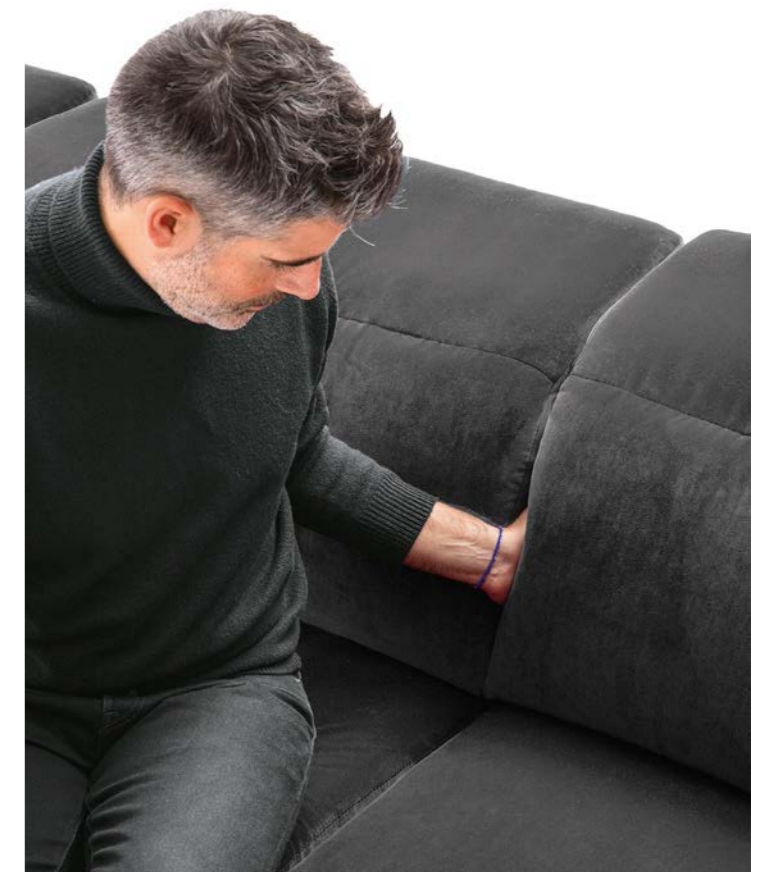

Glove

MECCANISMO ELETTRICO / ELECTRIC MECHANISM / MÉCANISME ÉLECTRIQUE / ELEKTRISCHER MECHANISMUS

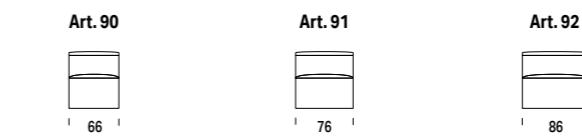
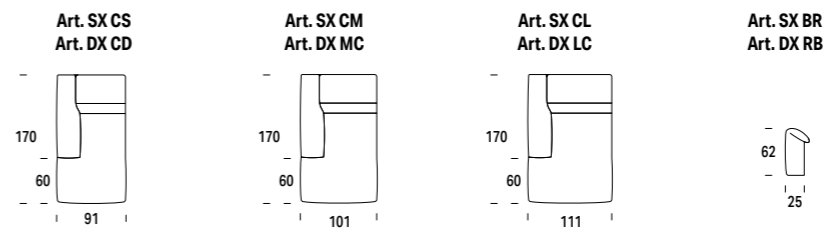
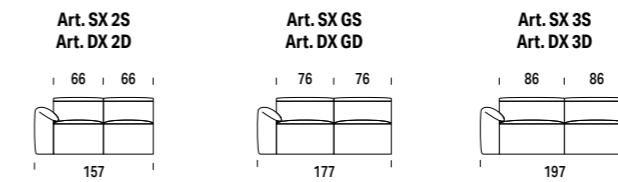
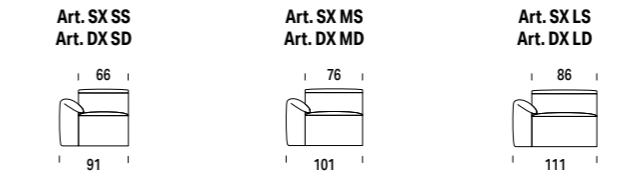
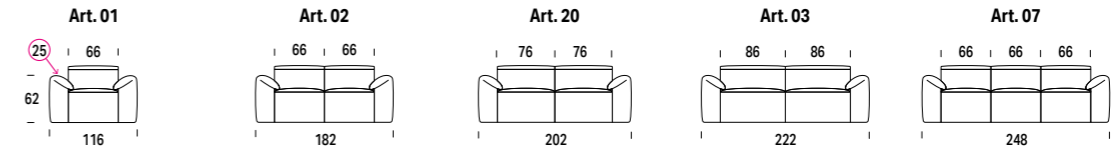
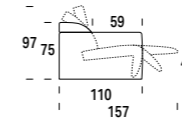
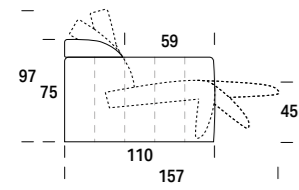

CARATTERISTICHE GENERALI / GENERAL FEATURES / CARACTÉRISTIQUES GÉNÉRALES / ALLGEMEINE PRODUKTMERKMALE

					
ELETTRICO ELECTRIC ÉLECTRIQUE ELEKTRISCH	TELECOMANDO REMOTE CONTROL TÉLÉCOMMANDE FERNBEDIENUNG	BATTERIA UPS UPS BATTERY BATTERIE UPS USV-BATTERIE	PORTATA 150Kg LOAD 150Kg PORTÉE 150Kg TRAGFÄHIGKEIT 150Kg	50.000 CICLI 50.000 CYCLES 50.000 CYCLES 50.000 ZYKLEN	MECCANICA GARANTITA 3 ANNI MECHANICS GUARANTEED FOR 3 YEARS MÉCANIQUE GARANTIE 3 ANS MECHANIK FÜR 3 JAHRE GARANTIERT

ZERO WALL

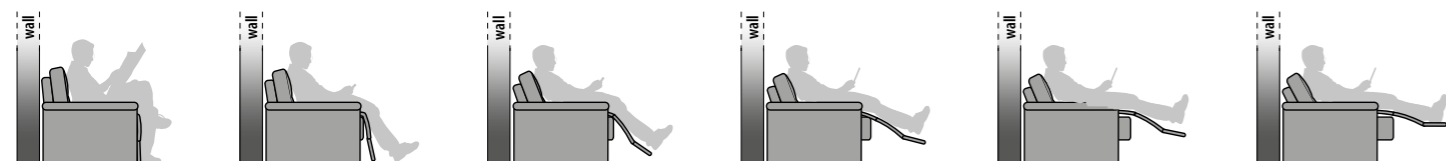

ESEMPI COMPOSITIVI / COMPOSITION EXAMPLES / EXEMPLES DE COMPOSITION / KOMPOSITORISCHE BEISPIELE

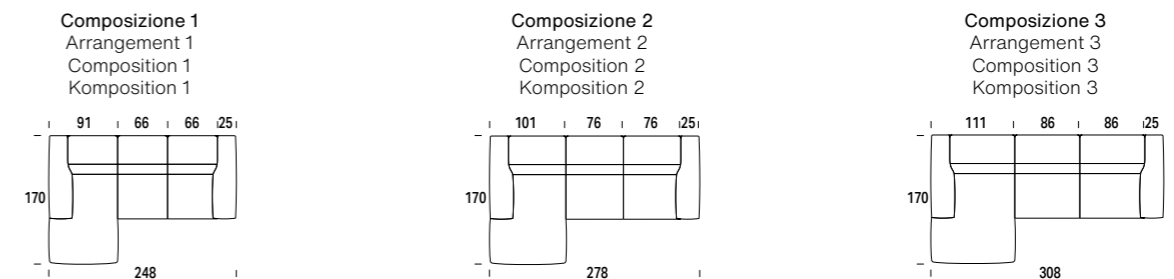

Gravity

COMPLETAMENTE SFODERABILE / COMPLETELY REMOVABLE FABRIC COMPLÈTEMENT DÉHOUSSABLE / VOLLSTÄNDIG ENTFERNBAR

STRUTTURA

Sedute realizzate con pannelli in multistrato da 18mm rinforzate con masselli portanti in legno di abete massiccio di spessore 30mm.
Schiene realizzate in agglomerato di legno da 18mm.

Il tutto in classe E1, pertanto a bassa emissione di formaldeide.

IMBOTTITURA

Sedute in espanso indeformabile 30SR ricoperto con resinato da 200 gr. accoppiato a maglina 100% poliestere. Schiene in espanso indeformabile FEE21 ricoperto con resinato da 200 gr. accoppiato a maglina 100% poliestere. Cuscini schiena in "pelle d'uovo", cotone, poliestere a camere separate riempite con misto piuma sterilizzata e fiocco di poliestere vergine 100%.

PIEDI

In metallo pressofuso H.14 in due finiture: Nero opaco e Acciaio satinato. Dotato di gommino antiscivolo.

Piede in vetro trasparente H.14 fissato alla struttura tramite apposito sistema a staffe. Dotato di polimero trasparente fungente da antiscivolo e antigraffio.

FRAME

Seats made from 18 mm multi-layered panels reinforced with 30 mm thick solid fir wood supporting frame.
Backs made of 18mm particleboard. All in Class E1, therefore with low formaldehyde emissions.

PADDING

Seats made of 30SR non-deformable foam covered with 200 g resin bonded to 100% polyester jersey.
Backs made of FEE21 non-deformable foam covered with 200 g resin bonded to 100% polyester jersey.
Muslin back cushions made of cotton and polyester in separate chambers stuffed with sterilised mixed feather padding and 100% virgin polyester flock.

FEET

Die-cast H 14 metal foot available in two finishes: matt Black and satin-finished Steel. Fitted with non-slip rubber pad.
Transparent glass foot H.14 fixed to the frame by means of special bracket. Fitted with transparent non-slip, non-scratch polymer pad.

STRUCTURE

Assises réalisées avec des panneaux en multicouches de 18mm renforcées par du pin massif portant d'épaisseur 30mm. Dossiers réalisés en bois aggloméré de 18mm. Le tout en classe E1, donc à basse émission de formaldéhyde.

REMOURRAGE

Assises en expansé indéformable 30SR recouvert par 200gr de résiné accouplé à une petite maille 100% polyester.
Dossiers en expansé indéformable FEE21 recouvert par 200gr de résiné accouplé à une petite maille 100% polyester.
Coussins du dossier en "peau d'œuf", coton, polyester à chambres séparées rembourrées par un mixte de plume stérilisée et de flocon de polyester 100% vierge.

PIEDS

En métal moulé sous pression H. 14 en deux finitions : Noir opaque et Acier satiné. Équipé de caoutchouc antidérapant. Pied en verre transparent H. 14 fixé à la structure par un système à supports spécial. Équipé de polymère transparent agissant en tant qu'antidérapant et anti-rayures.

KORPUS

Sitzflächen aus 18mm Sperrholzplatten, verstärkt mit 30mm Massivholz aus Tanne als tragendes Element.
Rückenlehnen aus 18 mm Spanplatte. Alles entspricht der Klasse E1, also mit geringer Formaldehydabgabe.

POLSTERUNG

Sitzflächen aus formstabilem Schaumstoff in 30SR, bezogen mit gehärtetem Material zu 200g, auf das 100% Polyester-Jersey aufkaschiert ist.
Rückenlehnen aus formstabilem Schaumstoff in FEE21, bezogen mit gehärtetem Material zu 200g, auf das 100% Polyester-Jersey aufkaschiert ist.
Rückenkissen mit Musselinbezug, Baumwolle, Polyester, mit getrennten Kammern, die mit sterilisierten Federn und 100% Polyester-Stapelfaser gefüllt sind.

FÜSSE

Aus druckgegossenem Metall, H.14 mit zwei Finishs: Mattschwarz und Stahl satiniert. Ausgestattet mit rutschfestem Gummi.
Der transparente Glasfuß H.14 wird mit einem speziellen Halterungssystem an der Struktur befestigt. Ausgestattet mit transparentem Polymer, das rutschfest und kratzfest ist.

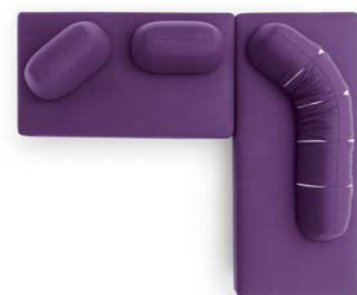
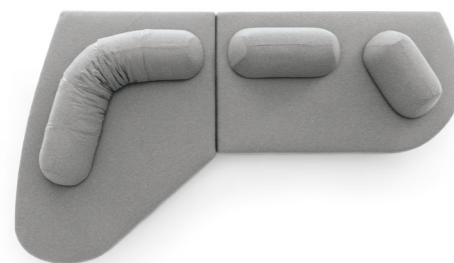
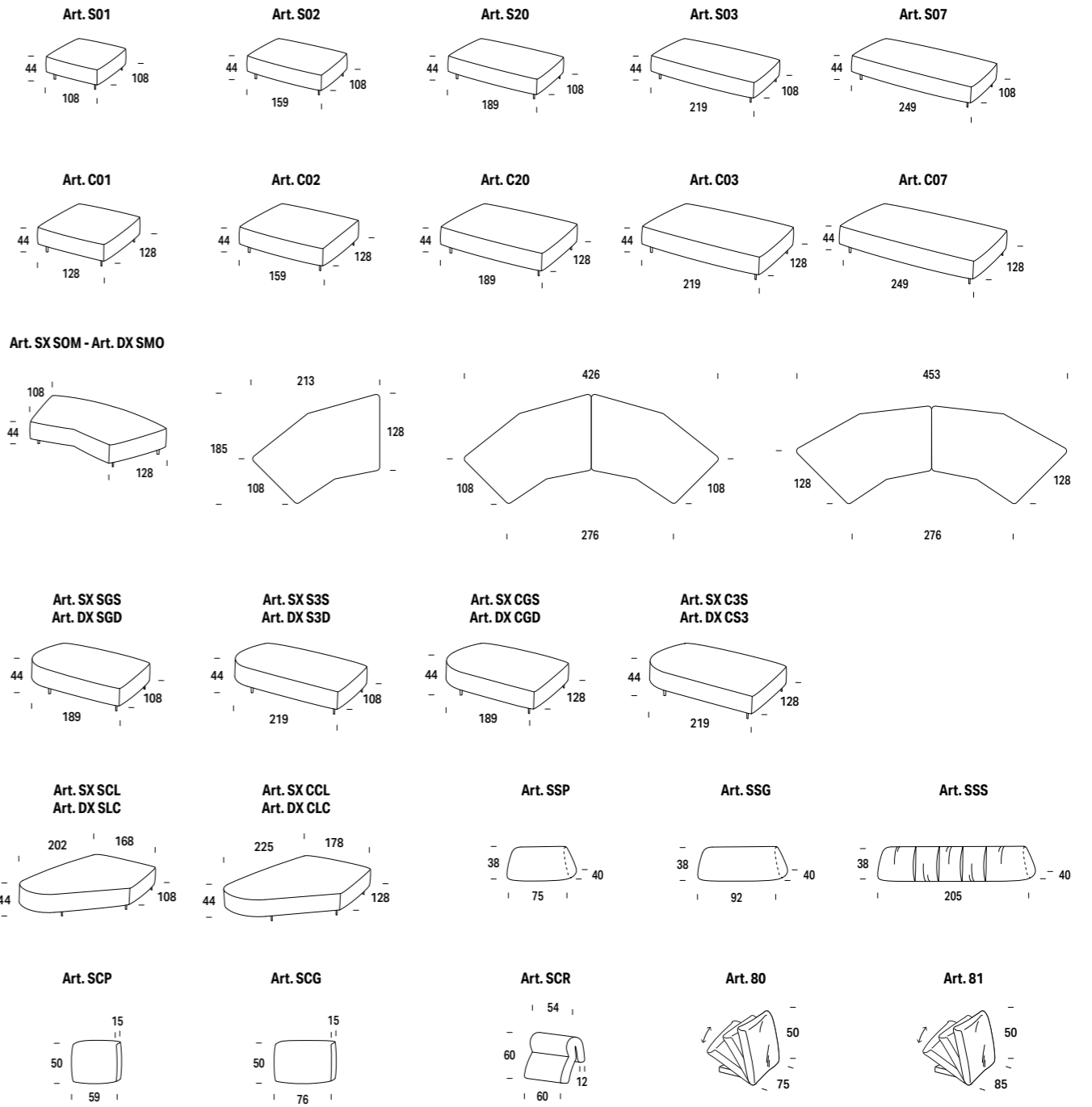

ESEMPI COMPOSITIVI / COMPOSITION EXAMPLES / EXEMPLES DE COMPOSITION / KOMPOSITORISCHE BEISPIELE

KRYSTAL H 14 OPTIONAL



Piede in vetro / Glass feet
Pied en verre / Fuß aus Glas

JADE H 14 OPTIONAL



Piedi neri / Black feet
Pieds noirs / Schwarze Füße

JADE H 14 OPTIONAL



Piedi satinati / Brushed feet
Pieds satinés / Satinierte Füße

Composizione 1 Arrangement 1 Composition 1 Komposition 1

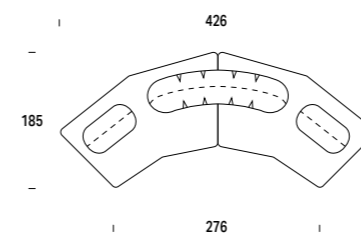

Composizione 2 Arrangement 2 Composition 2 Komposition 2

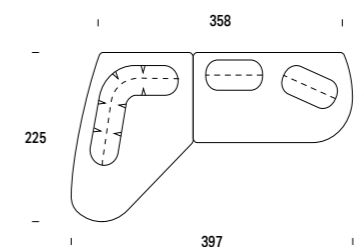

Composizione 3 Arrangement 3 Composition 3 Komposition 3

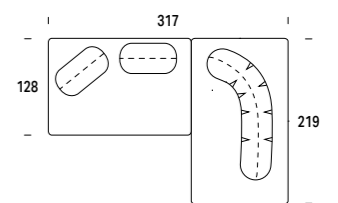

Icon

COMPLETAMENTE SFODERABILE / COMPLETELY REMOVABLE FABRIC COMPLÈTEMENT DÉHOUSSABLE / VOLLSTÄNDIG ENTFERNBAR

STRUTTURA

Struttura portante a pannelli di agglomerato di legno da 18 mm a bassa emissione di formaldeide (classe E1), con parti in legno massello di abete e/o pioppo e pannelli di fibre di legno compresse a caldo. Il tutto assemblato con colla vinilica a base di acqua e ferramenta di fissaggio, poi rivestito con resinato da 200g accoppiato a maglina 100% poliestere.

FRAME

Load-bearing frame made from low emissions 18mm particleboard panels (Class E1), with parts in solid fir and/or poplar wood and heat-compressed hardboard panels. All assembled using water-based vinyl glue and attachment hardware, then covered with 200g polyester resin bonded to 100% polyester jersey.

STRUCTURE

Structure portante de panneaux en bois aggloméré de 18mm à basse émission de formaldéhyde (classe E1), avec des parties en bois de pin massif et/ou peuplier et des panneaux de fibres de bois compressées à chaud. Le tout est assemblé avec de la colle vinylique à base d'eau et quincaillerie de fixation, ensuite revêtu par 200gr. de résin accouplé à une maille 100% polyester.

KORPUS

Tragende Struktur aus 18 mm dicken Spanplatten mit geringer Formaldehyd-Emission (Klasse E1), mit Massivholzteilen aus Tanne und/oder Pappel und heißgepressten Holzfaserplatten. Das Ganze wird mit Vinylkleber auf Wasserbasis und Befestigungselementen zusammengefügt und dann mit einem gehärteten Material zu 200g verkleidet, auf das 100% Polyester-Jersey aufkaschiert wurde.

IMBOTTITURA

Cuscino seduta in espanso indeformabile densità 35S. Cuscino schienale in espanso densità D25CM. Entrambi i cuscini sono rivestiti con falda termolegata da 300g.

PADDING

Seat cushion made of 35S density non-deformable foam. Back cushion made of D25CM density foam. Both cushions are covered in 300g thermo-bonded felt.

REMBOURRAGE

Coussin de l'assise en espanso indéformable densité 35S. Coussin du dossier en espanso densité D25CM. Les deux coussins sont revêtus par une couche thermo-liée de 300gr.

POLSTERUNG

Sitzkissen aus formbeständigem Schaumstoff Dichte 35S. Rückenkissen aus Schaumstoff Dichte D25CM. Beide Kissen sind mit einer wärmegebundenen Schicht zu 300g versehen.

MOLLEGGIO

Realizzato mediante nastri elastici da mm 80 tesi meccanicamente, composti da fili di gomma rivestiti da filo di nylon avvolto a spirale.

SPRINGING

Made of 80 mm wide mechanically tensioned webbing composed of nylon strands wound into a spiral.

RESSORTS

Réalisée avec des bandes élastiques de 80 mm tendues mécaniquement, composées par des fils de gomme recouverts par du fil de nylon enroulé à spirale.

FEDERUNG

Besteht aus elastischen, mechanisch gespannten 80mm breiten Gurten, die aus Gummifäden bestehen, die mit spiralförmig gewickelten Nylonfäden ummantelt sind.

PIEDI

Struttura tubolare in metallo dotato di gommino antiscivolo. Disponibile nelle finiture: cromo, nero opaco, giallo fluo, arancio fluo, verde salvia, rosa antico.

FEET

Tubular frame fitted with nonslip rubber pads. Available in the following finishes: chrome, matt black, yellow fluo, orange fluo, green sage, antique rose.

PIEDS

Structure tubulaire en métal doté de gomme antidérapante. Disponible dans les finitions: chrome, noir opaque, jaune fluorescent, orange fluorescent, vert sauge, vieux rose.

FÜSSE

Metallrohrrahmen mit rutschfestem Gummi. Erhältlich in den folgenden Ausführungen: Chrom, Mattschwarz, fluoreszierendes Gelb, fluoreszierendes Orange, Salbeigrün, Altrosa.

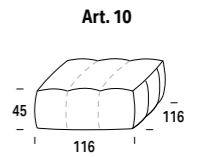
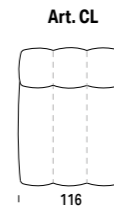
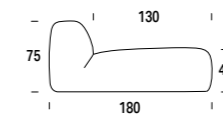
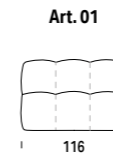
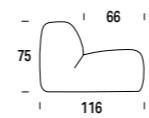
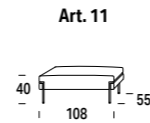
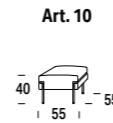
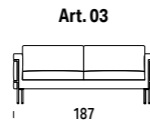
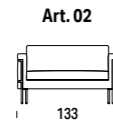
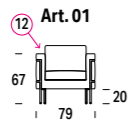
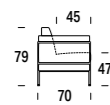

- Cromo**
Chrome / Chrome / Chrom
- Rosa antico**
Antique rose / Vieux rose
Altrosa
- Verde salvia**
Green sage / Vert sauge
Salbeigrün
- Nero opaco**
Matt black / Noir mat
Mattschwarz
- Giallo fluo**
Fluo yellow / Jaune fluo
Fluoreszierendes Gelb
- Arancio fluo**
Fluo orange / Orange fluo
Fluoreszierendes Orange

Muffin

STRUTTURA

Struttura realizzata con masselli portanti in legno di abete massiccio di vari spessori, parti di tamponamento in fibra grezza e/o compensato. Fianchi in agglomerato di legno e/o multistrato di legno da 18 mm. Fibra grezza e agglomerato di legno in classe E1, pertanto a bassa emissione di formaldeide. Il telaio è rivestito con resinato da 200 gr. termoaccoppiato a vellutino 100% poliestere.

FRAME

Made of solid fir wood in various thicknesses. Reinforcement parts in wood fibre and/or plywood. Sides made of 18 mm particleboard and/or multilayered wood. Wood fibre and particleboard Class E1 therefore low formaldehyde emissions. The frame is covered with 200 gr resin, thermocoupled to 100% polyester velveteen.

STRUCTURE

Réalisée en bois massif de sapin portant de différentes épaisseurs. Fileurs de remplissage en fibre brute et/ou contreplaqué. Côtés en aggloméré de bois et/ou multicouches de bois 18 mm. Fibre brute et aggloméré de bois en Classe E1, donc à basse émission de formaldéhydes. Le châssis est revêtu par du velours 100% polyamide couplé à chaud à de l'ouate résinée de 200 gr. 100% polyester.

KORPUS

Aufbau aus massivem Tannenholz in verschiedenen Stärken, Füllungen aus Rohfaser und/oder Sperrholz. Seiten aus 18 mm Spanplatte. Alles entspricht der Klasse E1, also mit geringer Formaldehydabgabe. Der Rahmen ist mit 200 gr Resinat überzogen, das mit 100% Polyester Samt verbinden ist.

IMBOTTITURA

Seduta in poliuretano espanso indeformabile D45 SR. Schienale e braccioli in espanso indeformabile D18 SS.

PADDING

Seat made of non-deformable polyurethane foam D45 SR. Backrest and armrests made of non-deformable foam D18 SS.

REMBOURRAGE

Assise en espanso indéformable de polyuréthane D45 SR. Dossier et accoudoirs en espanso flexible et indéformable de polyuréthane D18 SS.

POLSTERUNG

Der Sofasitz besteht aus unverformbarem Polyurethanschaum D45 SR. Rückenlehne und Armlehnen bestehen aus Polyurethanschaum D18SS.

MOLLEGGIO

Realizzato con nastri elastici da 80 mm tesi meccanicamente, composti da fili di nylon avvolti a spirale.

SPRINGING

Made of 80 mm wide mechanically tensioned webbing composed of nylon strands wound into a spiral.

SUSPENSION

Réalisée avec des bandes élastiques de 80 mm tendues mécaniquement, composées par des fils de gomme recouverts par du fil de nylon enroulé à spirale.

FEDERUNG

Hergestellt aus mechanisch gedehnten 80-mmElastikbändern, bestehend aus spiralförmig gewickelten Nylonfäden.

PIEDI

Piedi in ABS nero da H 40 mm, non visibili.

FEET

Black ABS plastic feet H 40 mm, not visible.

PIEDS

Pieds en ABS noir H. 40 mm, non visibles.

FÜSSE

Füße aus schwarzem ABS H. 40mm nicht sichtbar.

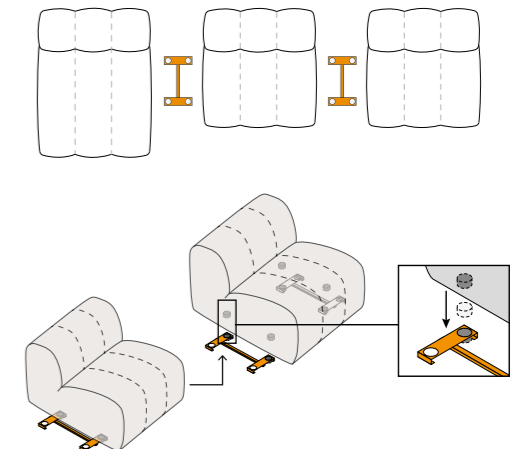

ESEMPI COMPOSITIVI / COMPOSITION EXAMPLES / EXEMPLES DE COMPOSITION / KOMPOSITORISCHE BEISPIELE

Composizione 1
Arrangement 1
Composition 1
Komposition 1

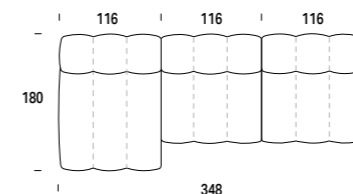

Composizione 2
Arrangement 2
Composition 2
Komposition 2

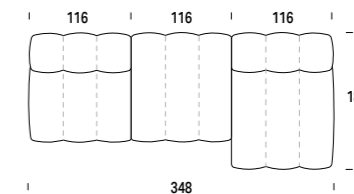

Kensington

COMPLETAMENTE SFODERABILE / COMPLETELY REMOVABLE FABRIC COMPLÈTEMENT DÉHOUSSABLE / VOLLSTÄNDIG ENTFERNBAR

STRUTTURA

Realizzata con masselli portanti in legno di abete massiccio di vari spessori, parti di tamponamento in fibra grezza e/o compensato di legno. Struttura in agglomerato di legno e/o multistrato da 18 mm. Il tutto è in classe E1, pertanto a bassa emissione di formaldeide. Il tutto ricoperto con vellutino 100% poliammide accoppiato ad espanso e/o resinato da 200 gr. accoppiato a maglina 100% poliestere.

IMBOTTITURA

Cuscino seduta in espanso indeformabile D35.SE ricoperto con resinato da 200 gr. Accoppiato a maglina 100% poliestere. Cuscino schienale e poggiatesta in espanso indeformabile D16 morbido ricoperto con resinato da 200 gr. accoppiato a maglina 100% poliestere termofissato a vellutino. Bracciolo in espanso indeformabile in D30 - D21 con falda da 300 gr. termolegata. Il tutto ricoperto con resinato 200 gr. accoppiato a maglina 100% poliestere.

MOLLEGGIO

Realizzato in nastri da 80 mm tesi meccanicamente, composti da fili in nylon avvolto a spirale.

PIEDI

Piedi in ABS nero H40 mm non visibile.

FRAME

Construction features load-bearing frames in solid fir wood of various thicknesses, reinforcement parts made of rough fibre and/or plywood. Structure made of 18 mm chipboard and/or 18 mm multi-layered wood. All Class E1, therefore low formaldehyde emissions. Completely covered with 100% polyamide velveteen bonded to 200 g foam and/or resin bonded to 100% polyester jersey.

UPHOLSTERY

Seat cushion made of D35.SE nondeformable foam covered with 200g resin bonded to 100% polyester jersey. Back cushion and headrest made of soft D16 non-deformable foam covered with 200g resin bonded to 100% polyester jersey thermo-fixed to velveteen. Armrest made of D30 - D21 non deformable foam with 300 g thermo-bonded lap. Completely covered with 200 g resin bonded to 100% polyester jersey.

SPRINGS

Mechanically tensioned 80 mm wide bands, composed of spiral-wound nylon strands.

FEET

H40 mm ABS plastic feet, not visible.

STRUCTURE

Réalisée en bois de pin massif portant de différentes épaisseurs, les parties de remplissage sont en fibre brute et/ou en bois compensé. Structure en bois aggloméré et / ou en multicouches de 18 mm. Le tout en classe E1, avec une basse émission de formaldéhyde. Tout est recouvert de velours 100% polyamide accouplé à 200 gr. d'expansé et/ou de résiné accouplé à une maille 100% polyester.

REMBOURRAGE

Coussin d'assise en expansé indéformable D35.SE recouvert par un résiné de 200 gr. accouplé à une maille 100% polyester. Coussin dossier et appuie-tête en expansé indéformable D16 souple recouvert par un résiné de 200 gr. accouplé à une maille 100% velours polyester fixée par chaleur. Accoudoirs en expansé indéformable en D30-D21 avec couverture de 300 gr. attachée par chaleur. Le tout recouvert avec un résiné de 200 gr. accouplé à une maille 100% polyester.

RESSORTS

Réalisés en bandes de 80 mm. tendus mécaniquement, composés par des fils en nylon enroulés à spirale.

PIEDS

Pieds en ABS noir H. 40 mm invisibles.

KORPUS

Aus massivem Tannenholz in verschiedenen Stärken, Füllungen aus Rohfaser und/ oder Sperrholz. Seiten aus 18 mm Spanplatte. Alles entspricht der Klasse E1, also mit geringer Formaldehydabgabe. All dies ist mit Samt aus 100% Polyamid bezogen, der mit Schaumstoff und/oder geharztem Material zu 200 g heiß aufkaschiert wurde, der bzw. das wiederum auf Samt aus 100% Polyesterfaser heiß aufkaschiert wurde.

POLSTERUNG

Sitzkissen aus unverformbarem Schaumstoff D35 SE mit 200 g Harz bezogen. gepaart mit 100% Polyester Pullover. Rückenkissen und Kopfstütze aus unverformbarem Schaumstoff D16 weich bezogen mit 200 gr Harz. gepaart mit 100% Polyester Pullover thermofixiertem Samt. Armlehne aus unverformbarem Schaumstoff aus D30 - D21 mit 300 gr Klappe. thermogebunden. Alles mit Harz 200 gr bedeckt. gepaart mit 100% Polyester Pullover.

FEDERUNG

Besteht aus elastischen, mechanisch gespannten 80mm breiten Gurten, die aus Gummifäden bestehen, die mit spiralförmig gewickelten Nylonfäden ummantelt sind.

FÜSSE

40 mm hohe Füße aus nicht sichtbarem ABS in Schwarz.

DISPONIBILE IN VERSIONE FISSA O ELETTRICA
AVAILABLE AS FIXED OR ELECTRIC VERSIONS
DISPONIBILE EN VERSION FIXE OU ÉLECTRIQUE
ERHÄLTICH IN FESTSTEHENDER ODER ELEKTRISCH VERSTELLBARER AUSFÜHRUNG



VERSIONE FISSA

Con poggiatesta manuale dotato di meccanica a cricchetto.

FIXED VERSION

Featuring manual headrest fitted with ratchet mechanism.

VERSION FIXE

Avec appuie-tête manuel doté de mécanisme à cliquet.

FESTSTEHENDE VERSION

Mit manueller Kopfstütze und Ratschenmechanismus.



DISPONIBILE IN VERSIONE MANUALE OPPURE ELETTRICA, CONSULTARE IL LISTINO PER LE POSSIBILI SOLUZIONI.

AVAILABLE IN MANUAL OR ELECTRIC VERSION, CONSULT THE PRICE LIST FOR ALL POSSIBLE SOLUTIONS.

DISPONIBILE EN VERSION MANUELLE OU ÉLECTRIQUE, CONSULTEZ LA LISTE DE PRIX POUR TOUTES LES POSSIBLES SOLUTIONS.

VERFÜGBAR IN MANUELLER ODER ELEKTRISCHER VERSION, KONSULTIEREN SIE DIE PREISLISTE FÜR MÖGLICHE LÖSUNGEN.



VERSIONE ELETTRICA

Con doppia motorizzazione (seduta e poggiatesta).

ELECTRIC VERSION

Features dual motorisation (seat and headrest).

VERSION ÉLECTRIQUE

Avec double motorisation (assise et appuie-tête).

ELEKTRISCH VERSTELLBARE VERSION

Mit doppelter Motorisierung (Sitzfläche und Kopfstütze).



Kensington

Il pratico telecomando aziona due motori elettrici in modo indipendente per regolare poggiatesta e/o seduta. Grazie al meccanismo Zero Wall, si può scegliere l'inclinazione preferita senza allontanare il divano dal muro.

Nel caso in cui si opti per una seduta fissa insieme a una elettrica, è necessario specificare la posizione di quest'ultima (dx/sx).

The practical remote control drives two electric motors, which independently adjust the headrest and/or seat. The Zero Wall mechanism enables you to choose your favourite reclining position without moving the sofa away from the wall.

If you opt for a section featuring both fixed and electric seat, please specify the position of the electric seat (right or left).

Le télécommande pratique actionne deux moteurs électriques de façon indépendante afin de régler appuie-tête et/ou assise. Grâce au mécanisme Zero Wall, vous pouvez choisir l'inclinaison préférée sans devoir éloigner le canapé du mur.

Dans le cas où vous optiez pour une assise fixe associée à une électrique, il est nécessaire de spécifier la position de cette dernière (d./g.)

Die praktische Fernbedienung steuert zwei Elektromotoren unabhängig voneinander zur Verstellung von Kopfstütze und/oder Sitz. Dank des Zero-Wall-Mechanismus können Sie Ihre bevorzugte Neigung einstellen, ohne das Sofa von der Wand abrücken zu müssen.

Wenn Sie sich für einen feststehenden und einen elektrisch verstellbaren Sitz entscheiden, müssen Sie die Position des letzteren angeben (rechts/links).



CARTER DI COPERTURA FORNITO DI SERIE
COVERING CARTER SUPPLIED AS STANDARD
CARTER DE COUVERTURE FOURNI EN STANDARD
STANDARDMÄSSIGE ABDECKUNG

SFODERABILE AL 100%
I rivestimenti sono completamente sfoderabili per consentire pulizia e manutenzione con la massima praticità.

100% REMOVABLE COVERS
The covers are all removable to ensure highly practical cleaning and maintenance.

100% DÉHOUSABLE
Les revêtements sont complètement déhoussables afin de permettre un nettoyage et une manutention très pratique.

ZU 100% ABNEHMBARE BEZÜGE
Die Bezüge sind vollständig abnehmbar, um die Reinigungs- und Pflegearbeiten zu erleichtern.



SALVAMONETE
Anche quando il divano si inclina, nessun oggetto può finire all'interno della struttura grazie a un tessuto di collegamento tra seduta e schienale.

SAUVE MONNAIE
Même lorsque le canapé s'incline, aucun objet ne peut finir à l'intérieur de la structure grâce au tissu de liaison entre l'assise et le dossier.

COIN SAVER
Even when the sofa is reclining, no object can get into the frame as a layer of fabric connects the seat to the backrest.

MÜNZAUFFANG
Selbst wenn das Sofa geneigt wird, können dank einer Stoffverbindung zwischen Sitz und Rückenlehne keine Gegenstände in das Innere der Struktur gelangen.



Kensington

MECCANISMO ELETTRICO / ELECTRIC MECHANISM / MÉCANISME ÉLECTRIQUE / ELEKTRISCHER MECHANISMUS

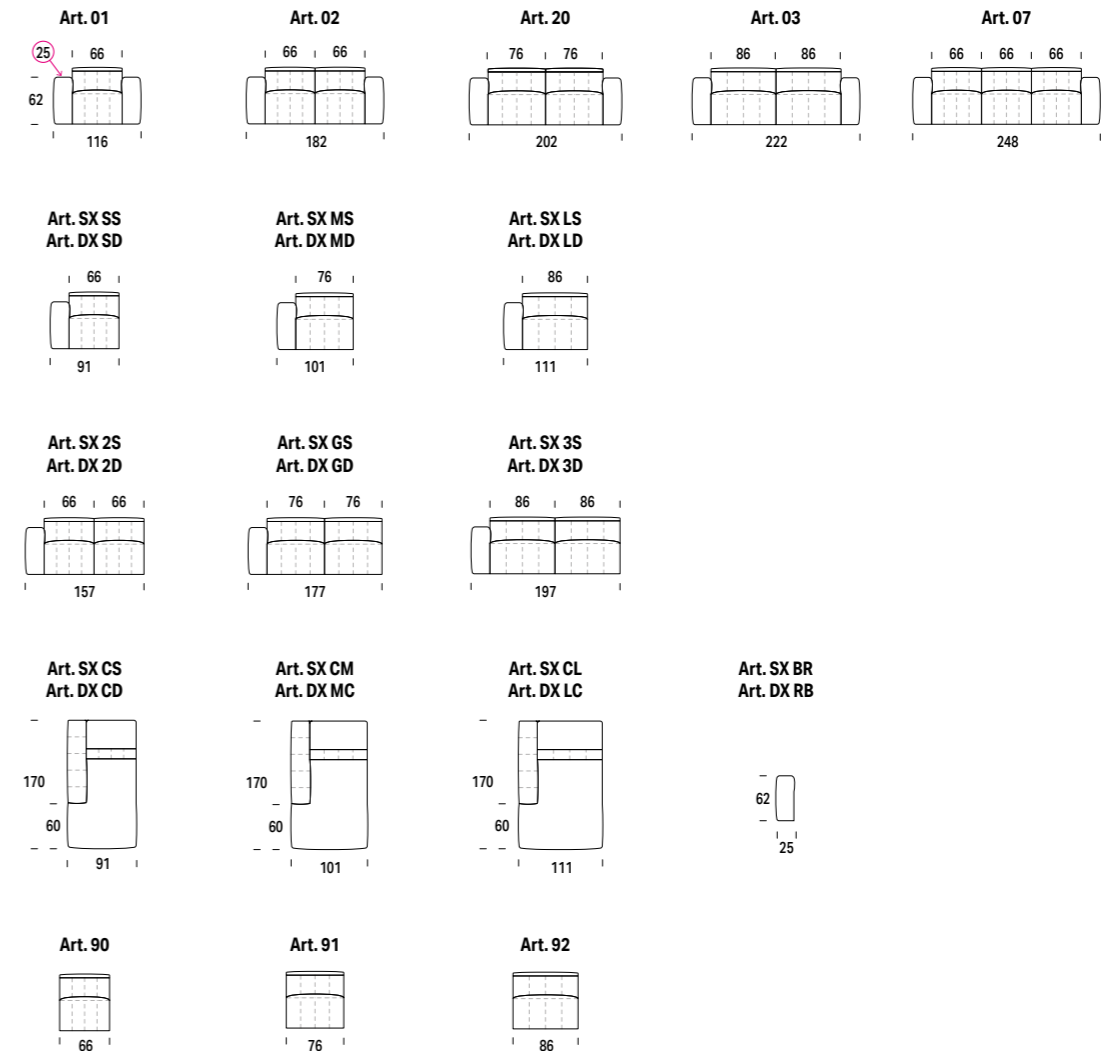
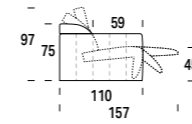
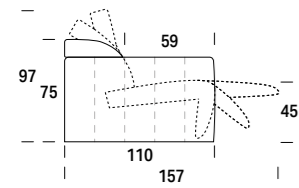

CARATTERISTICHE GENERALI / GENERAL FEATURES / CARACTÉRISTIQUES GÉNÉRALES / ALLGEMEINE PRODUKTMERKMALE

					
ELETTRICO ELECTRIC ÉLECTRIQUE ELEKTRISCH	TELECOMANDO REMOTE CONTROL TÉLÉCOMMANDE FERNBEDIENUNG	BATTERIA UPS UPS BATTERY BATTERIE UPS USV-BATTERIE	PORTATA 150Kg LOAD 150Kg PORTÉE 150Kg TRAGFÄHIGKEIT 150Kg	50.000 CICLI 50.000 CYCLES 50.000 CYCLES 50.000 ZYKLEN	MECCANICA GARANTITA 3 ANNI MECHANICS GUARANTEED FOR 3 YEARS MÉCANIQUE GARANTIE 3 ANS MECHANIK FÜR 3 JAHRE GARANTIERT

ZERO WALL

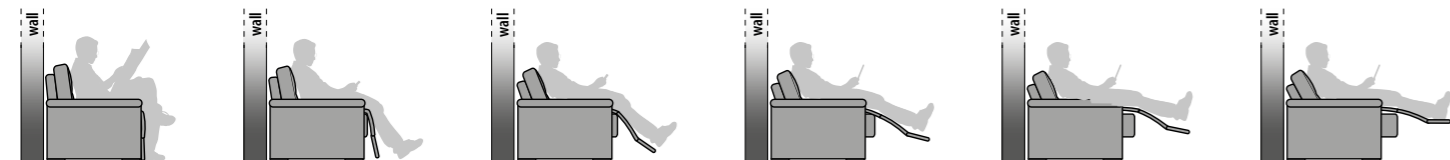

ESEMPI COMPOSITIVI / COMPOSITION EXAMPLES / EXEMPLES DE COMPOSITION / KOMPOSITORISCHE BEISPIELE

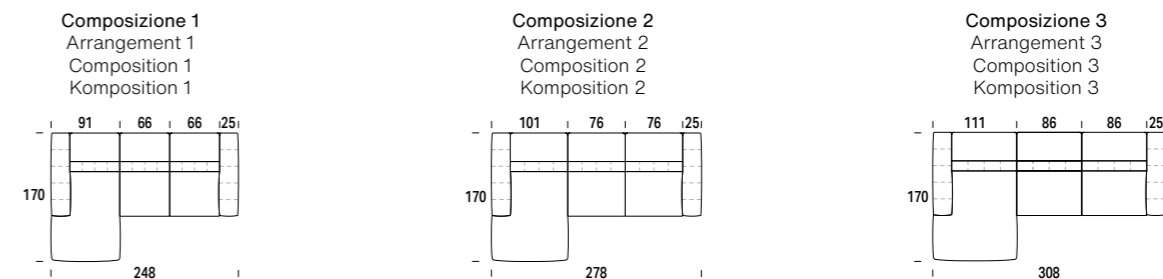

Larson

COMPLETAMENTE SFODERABILE / COMPLETELY REMOVABLE FABRIC COMPLÈTEMENT DÉHOUSSABLE / VOLLSTÄNDIG ENTFERNBAR

STRUTTURA

Realizzata con masselli portanti in legno di abete massiccio di vari spessori. Parti di tamponamento in fibra grezza e/o compensato. Telaio in multistrato da 18 mm. Fibra grezza e agglomerato di legno in classe E1, pertanto a bassa emissione di formaldeide. I braccioli sono ancorati alla base con baionette. Il telaio è completamente rivestito con poliuretano accoppiato a maglina resinata da 200 g 100% poliestere.

IMBOTTITURA

Tamponi braccioli e tamponi schiena in espanso D.21 - D40 PH. Portanza 8.0. Seduta in lastra di espanso D.35 SR - D.25 PH. Schiena in lastra di espanso D.21 morbido. Entrambe ricoperte da imbottitura in "pelle d'uovo", cotone poliestere a camere separate riempite per 50% con piuma d'oca sterilizzata e per 50% con fiocco vergine di poliestere 100%.

MOLLEGGIO

Il molleggio è realizzato in nastri da 80 mm tesi meccanicamente, composta da fili di nylon avvolto a spirale.

PIEDI

Barra perimetrale in metallo verniciata con polveri epossidiche. Con inserto godronato cromato con gommino antiscivolo.

FRAME

Made of solid fir wood in various thicknesses. Reinforcement parts in wood fibre and/or plywood. 18 mm plywood frame. Wood fibre and particleboard Class E1 therefore low formaldehyde emissions. The armrests are anchored to the base by means of bayonet fittings. The frame is completely upholstered with 200 g 100% polyester resin bonded to jersey.

PADDING

D.21 - D.25 PH armrest and backrest reinforcements. Lift 8.0. Seat made of D.35 SR - D40 PH foam sheet. Back made of D.21 soft foam sheet. Both covered with muslin, cotton and polyester padding in separate chambers filled 50% with sterilised goose feather and 50% with 100% virgin polyester flock.

SPRINGING

Made of 80 mm wide mechanically tensioned webbing composed of nylon strands wound into a spiral.

FEET

Metal perimeter bar coated with epoxy powder paint. Chromeplated knurled insert with non-slip rubber pad.

STRUCTURE

Réalisée par des porteurs en bois de pin massif de différentes épaisseurs. Parties de bandes fileurs en fibre brute et/ou en contre-plaqué. Châssis en bois stratifié de 18 mm. Fibre brute et en aggloméré de bois classe E1, pour autant à basse émission de formaldéhyde. Les accoudoirs sont encrés à la base par des baionnettes. Le châssis est complètement revêtu par 200 g d'accouplé en jersey résiné 100% polyester.

REMBOURRAGE

Bandes fileurs des accoudoirs et bandes fileurs du dossier D.21 - D40 PH. Portance 8.0. Assise en plaque expansée D.35 SR - D.25 PH. Dossier en plaque expansée D.21 souple. Chacune recouverte de rembourrage en coton coquille, coton polyester à chambres séparées remplies par 50% de plume d'oie stérilisée et par 50% de fibres vierges de polyester 100%.

RESSORTS

Réalisée avec des bandes élastiques de 80 mm tendues mécaniquement, composées par des fils de gomme recouverts par du fil de nylon enroulé à spirale.

PIEDS

Barre périphérique en métal verni par des poudres époxydes. Avec plaquette cannelée chromée et gomme antidérapante.

KORPUS

Aus massivem Tannenholz in verschiedenen Stärken, Füllungen aus Rohfaser und/ oder Sperrholz. Seiten aus 18 mm Spanplatte. Alles entspricht der Klasse E1, also mit geringer Formaldehydabgabe. All dies ist mit Samt aus 100% Polyamid bezogen, der mit Schaumstoff und/oder geharztem Material zu 200 g heiß aufkaschiert wurde, der bzw. das wiederum auf Samt aus 100% Polyesterfaser heiß aufkaschiert wurde.

POLSTERUNG

Polster von Armlehnen und Rückenlehne aus Schaumstoff D.21 - D40 PH. Tragfähigkeit 8,0. Sitzfläche mit Schaumstoffkern D.35 SR - D.25 PH. Rückenlehne mit Schaumstoffkern D.21 weich. Beide sind mit einer Musselin-Polsterung überzogen, Baumwolle, Polyester mit getrennten Kammern, die zu 50 % mit sterilisierten Gänsedaunen und zu 50 % mit 100% Polyester-Stapelfaser gefüllt sind.

FEDERUNG

Besteht aus elastischen, mechanisch gespannten 80mm breiten Gurten, die aus Gummifäden bestehen, die mit spiralförmig gewickelten Nylonfäden ummantelt sind.

FÜSSE

Umlaufender Metallstab mit Epoxid-Pulverbeschichtung. Mit verchromtem, gerändeltem Einsatz mit rutschfestem Gummi.

Con Larson, l'esperienza comfort si mantiene costante. I morbidi cuscini in piuma canalizzata rimangono sempre in forma e le ampie sedute non si scompongono mai grazie al tessuto anti-scivolo e alle cerniere che le ancorano agli schienali.

Larson ensures the comfort experience is on-going. The soft cushions filled with feather encased in sewn channels always keep their shape while the non-slip fabric and zips, which attach the cushions to the backrest, ensure the spacious seats always look impeccable.

Avec Larson, l'expérience confort est constante. Les coussins souples en plumes canalisées maintiennent toujours la forme et les larges assises ne se déforment jamais grâce au tissu antidérapant et aux fermetures éclaircs qui les encrent aux dossiers.

Mit Larson ist der Komfort garantiert. Die weichen Federkissen bleiben immer in Form und die breiten Sitzkissen immer an ihrem Platz, dank des rutschfesten Stoffs und der Reißverschlüsse, mit denen sie an den Rückenlehnen verankert sind.



Larson



PIEDINO
Barra perimetrale in metallo verniciata con polveri epossidiche. Con inserto godronato cromato con gommino antiscivolo.

FEET
Metal perimeter bar coated with epoxy powder paint. Chrome-plated knurled insert with non-slip rubber pad.

PIED
Barre périphérique en métal verni par des poudres époxydes. Avec plaquette cannelée chromée et gomme antidérapante.

FÜSSE
Umlaufender Metallstab mit Epoxid-Pulverbeschichtung. Mit verchromtem, gerändeltem Einsatz mit rutschfestem Gummi.



ANTISCIVOLO
I cuscini della seduta collegati allo schienale tramite cerniera divisibile e la presenza di un tessuto antiscivolo evitano lo slittamento in avanti.

NON-SLIP
Seat cushions attached to the backrests by divisible zips and non-slip fabric prevent cushions from sliding forward.

ANTIDÉRAPANT
Les coussins de l'assise sont liés au dossier par une fermeture éclair séparable et par la présence d'un tissu antidérapant qui évitent ainsi le glissement en avant.

VERRUTSCH-SCHUTZ
Die Sitzkissen sind mit einem rutschfesten Stoff bezogen und darüber hinaus per Reißverschluss an der Rückenlehne verankert, sodass sie nicht nach vorne verrutschen können.

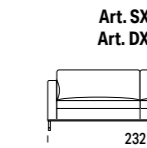
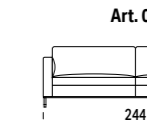
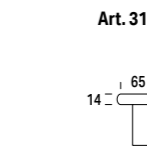
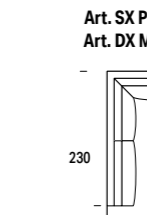
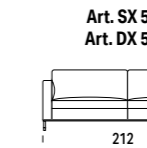
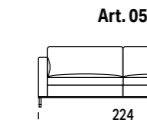
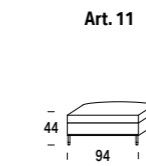
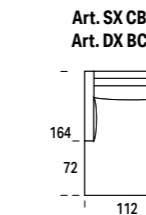
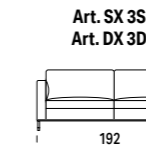
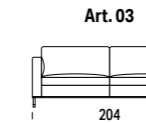
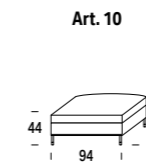
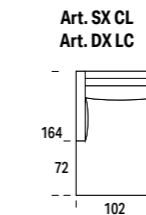
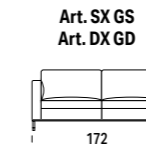
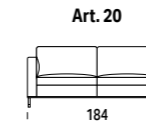
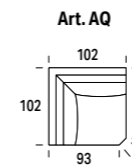
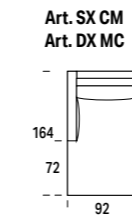
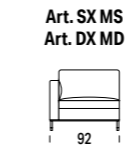
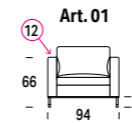
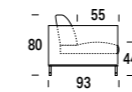

ESEMPI COMPOSITIVI / COMPOSITION EXAMPLES / EXEMPLES DE COMPOSITION / KOMPOSITORISCHE BEISPIELE

Composizione 1
Arrangement 1
Composition 1
Komposition 1

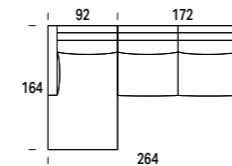

Composizione 2
Arrangement 2
Composition 2
Komposition 2

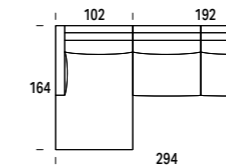

Composizione 3
Arrangement 3
Composition 3
Komposition 3

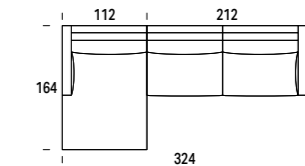

Composizione 4
Arrangement 4
Composition 4
Komposition 4

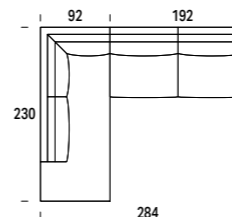

Composizione 5
Arrangement 5
Composition 5
Komposition 5

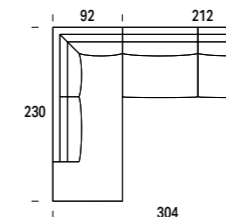

Composizione 6
Arrangement 6
Composition 6
Komposition 6

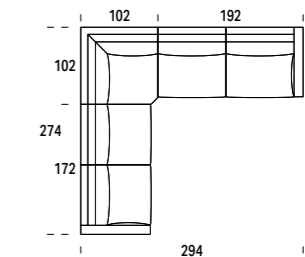

Limitless

COMPLETAMENTE SFODERABILE / COMPLETELY REMOVABLE FABRIC COMPLÈTEMENT DÉHOUSSABLE / VOLLSTÄNDIG ENTFERNBAR

STRUTTURA

Bracciolo e schienale in agglomerato di legno a bassa emissione di formaldeide con parti di tamponamento in fibra di legno e massello in abete, fissato tramite bulloni al pannello base, predisposto con forature atte a ricevere schiene e braccioli. Pannello in MDF nero (spessore 25 mm) con traforature che consentono lo scarico di umidità e facilitano il riciclo d'aria delle cuscinate.

FRAME

Armrest and backrest frame made of low formaldehyde emission particleboard. Reinforcement parts made of wood fibre and solid fir wood bolted to the base panel perforated to receive backrests and armrests. Black MDF panel (25 mm thick) with perforations to remove humidity and facilitate air circulation in the cushions.

STRUCTURE

Structure accouoir et dossier en aggloméré de bois à basse émission de formaldéhydes avec fileurs de remplissage en bois et pin massif, fixé par des écrous au panneau de base, prédisposé avec des fors prêts à accueillir dossier et accouoir. Panneau noir en MDF (épaisseur 25 mm.) avec des trous qui permettent l'évacuation de l'humidité et qui facilitent le recyclage de l'air des coussins.

STRUKTUR

Armlehne und Rückenlehne aus Holzagglomerat mit geringen Formaldehyd-Emissionen und Füllungsteilen aus Holzfasern und massiver Fichte, an der Bodenplatte verschraubt und vorgebohrt zur Aufnahme von Kissen und Armlehnen. Mehrschichtige Platte aus Birkenperrholz (30 mm dick) mit Bohrungen, die die Feuchtigkeit entweichen lassen und die Luftzirkulation der Kissen erleichtern.

IMBOTTITURA

Tutte le imbottiture sono realizzate con poliuretani indeformabili privi di sostanze SVHC, certificate non tossiche. Cuscini seduta in poliuretano espanso indeformabile densità D45, cuscini schienale in D18S; braccioli in D30. Tutto rivestito in falda da 300 gr termoaccoppiata ad agugliato in poliestere 100%, rivestiti con cuffia fissata alla struttura in resina di poliestere 100% accoppiata a vellutino poliestere 100% poliestere. Cuscini schiena in "pelle d'uovo", cotone, poliestere a camere separate riempite con misto piuma sterilizzata e fiocco di poliestere vergine 100%.

PADDING

All the padding is made of non-deformable polyurethanes free of SVHC substances, certified to be non-toxic. Seat cushions made of non-deformable D45 density polyurethane foam; back cushions made of D18S; armrests made of D30. All covered in a 300 g layer thermo-bonded to 100% polyester needle-punched fabric, covered with 100% polyester resin cover fixed to the structure bonded to 100% polyester velvet. Muslin back cushions made of cotton and polyester in separate chambers stuffed with sterilised mixed feather padding and 100% virgin polyester flock.

REMBOURRAGE

Tous les rembourrages sont réalisés en polyuréthane expansé indéformable sans substances SVHC, certifiés non toxiques. Coussins assise en polyuréthane expansé indéformable de densité D45; les coussins dossier sont en expansé de polyuréthane D18S; accouoirs en D30. Le tout recouvert en couche de 300gr couplée à chaud avec du 100% polyester soufflé, recouvert avec coiffe fixée à la structure en résine de polyester 100% couplée à du velours 100% polyester. Coussins du dossier en "peau d'oeuf", coton, polyester à chambres séparées rembourrées par un mixte de plume stérilisée et de flocon de polyester 100% vierge.

POLSTERUNG

Alle Polsterungen bestehen aus nichtverformbaren Polyurethanen, die frei von SVHC-Stoffen sind und als ungiftig zertifiziert wurden. Sitzkissen aus nicht verformbarem Polyurethanschaum mit Dichte D45, Rückenissen in D18S; Armlehnen in D30. Alle sind mit 300 g thermogekoppeltem Polyester-Nadelfilz (100 %) gepolstert und mit einem Bezug aus Polyesterharz (100 %) und Polyestersamt (100 %) an der Struktur befestigten überzogen. Rückenissen mit Musselinbezug, Baumwolle, Polyester, mit getrennten Kammern, die mit sterilisierten Federn und 100% Polyester-Stapelfaser gefüllt sind.

PIEDI

In metallo H 120 mm con finitura carbon look, disponibile nella versione stiletto classico o stiletto con base Ray Circle (optional). Completo di gommini antiscivolo.

FEET

In metal H 120 mm with carbon look finish, available in the classic stiletto version or stiletto with Ray Circle base version (optional). Complete with non-slip rubber pads.

PIEDS

En métal H 120 mm avec finition carbon look, disponible en version stiletto classique ou stiletto avec base Ray Circle (en option). Complet avec patins en caoutchouc antidérapants.

FÜSSE

Die Füße sind aus Metall, haben eine Höhe von 120 mm und sind in der klassischen Stiletto-Version oder in der Stiletto-Version mit Ray-Circle-Sockel (optional) erhältlich. Komplet mit rutschfesten Gummipads.

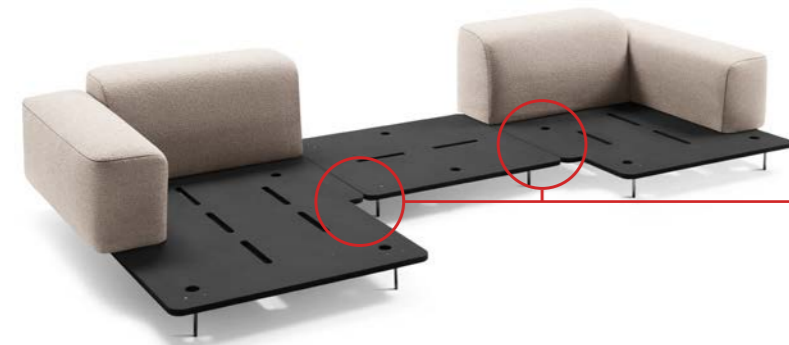

Il cuscino della seduta è amovibile e ritorna facilmente in posizione grazie ad un pratico innesto posto alla base.

The seat cushion is removable and easily clicks back into position thanks to a practical slot located on the base.

Le coussin du siège est amovible et revient facilement en position grâce à un mécanisme de raccordement pratique situé à la base.

Das Sitzkissen ist abnehmbar und kehrt leicht wieder in seine Position zurück, und zwar dank einer praktischen Einkupplung an der Basis.

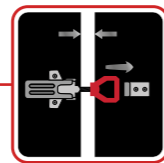

APERTO
OPEN
OUVERT
OFFEN

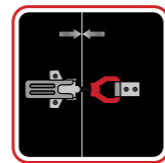

CHIUSO
CLOSED
FERMÉ
GESCHLOSSEN

RAY
STANDARD



RAY CIRCLE
OPTIONAL

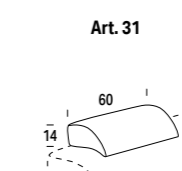
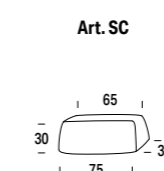
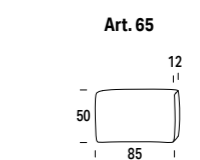
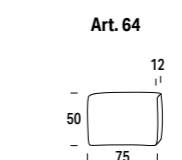
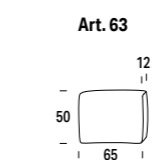
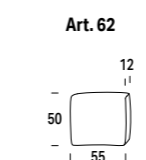
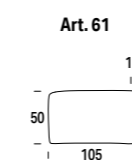
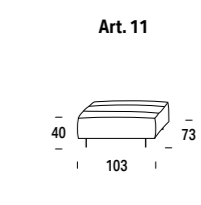
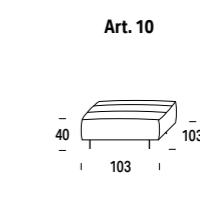
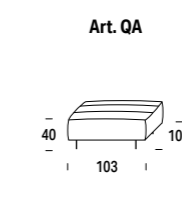
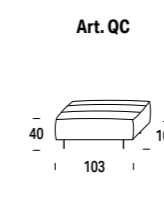
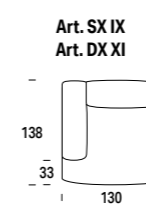
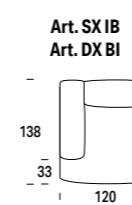
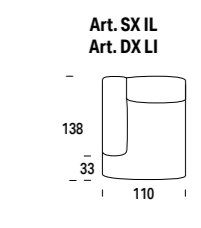
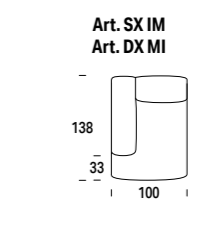
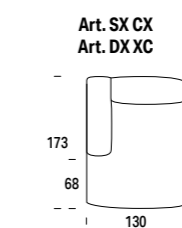
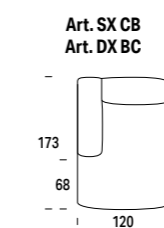
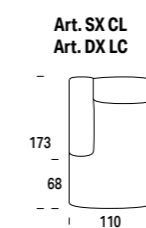
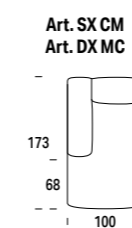
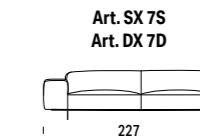
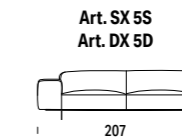
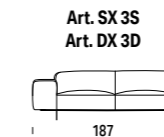
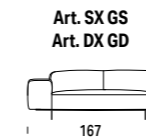
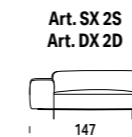
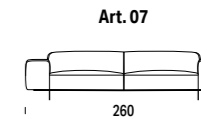
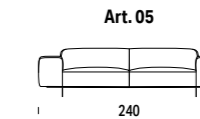
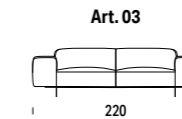
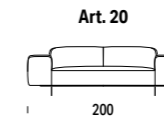
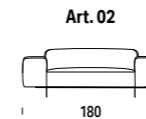
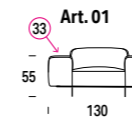
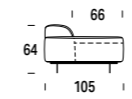

ESEMPI COMPOSITIVI / COMPOSITION EXAMPLES / EXEMPLES DE COMPOSITION / KOMPOSITORISCHE BEISPIELE

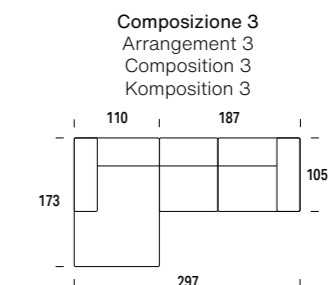
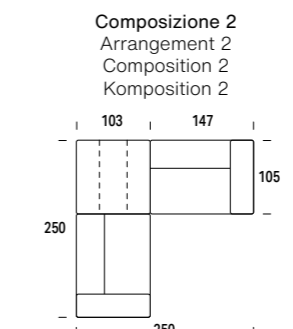
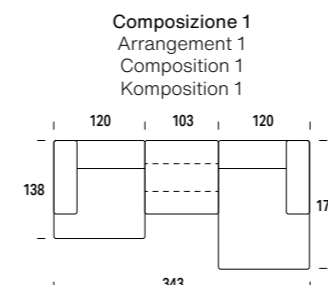

Love - Story

COMPLETAMENTE SFODERABILE / COMPLETELY REMOVABLE FABRIC COMPLÈTEMENT DÉHOUSSABLE / VOLLSTÄNDIG ENTFERNBAR

STRUTTURA

Struttura portante a pannelli di agglomerato di legno da 18 mm a bassa emissione di formaldeide (classe E1). Il tutto rivestito con resinato da 200g accoppiato a maglina 100% poliestere. Struttura tubolare in metallo carbon look.

FRAME

Bearing structure with low formaldehyde emission 18mm wooden back panels (class E1). The entire structure is coated with 200 g resin, coupled with 100% polyester jersey. Carbon look, metal tubular structure.

STRUCTURE

Structure portante en panneaux de bois aggloméré de 18 mm à basse émission de formaldéhyde (classe E1). Le tout revêtu par 200 g. de résiné accouplé à de la maille 100% polyester. Structure tubulaire en métal look carbone.

KORPUS

Tragende Struktur aus 18 mm starken Holz-Agglomeratplatten mit geringer Formaldehyd-Emission (Klasse E1). Das Ganze ist mit 200g Harz und 100% Polyester laminiert. Rohrrahmen aus Metall in Karbon-Optik.

IMBOTTITURA

Cuscino seduta in espanso indeformabile densità 35S. Cuscino schienale in espanso densità D25CM. Entrambi i cuscini sono rivestiti con falda termolegata da 300g.

PADDING

Non-deformable foam seat cushion, density 35S. Foam backrest cushion, density D25CM. Both cushions are coated with 300g thermo-bonded layer.

REMBOURRAGE

Coussin d'assise en expansé indéformable densité 35S. Coussin du dossier en expansé densité D25CM. Tous les deux revêtus par 300 gr. de couche thermo-liée.

POLSTERUNG

Sitzkissen aus unverformbarem Schaumstoff mit einer Dichte von 35S. Rückenissen aus Schaumstoff mit einer Dichte von D25CM. Beide Kissen sind mit einem 300 g schweren, thermoverklebten Überzug ausgestattet.

PIEDI

Poltroncina dotata di due piedi antiscivolo in ABS e 2 rotelline antiraffio.

FEET

Armchair fitted with two anti-slip ABS feet and 2 scratch resistant wheels.

PIEDS

Petit fauteuil doté de deux pieds antidérapants en ABS et deux roues anti-rayures.

FÜSSE

Ein kleiner Sessel mit zwei rutschfesten ABS-Füßen und zwei Anti-Kratz-Rollen.

LOVE



Art. 01



STORY



Art. 01



NEMESI POUF



Art. 01

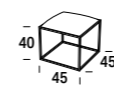

Art. 02

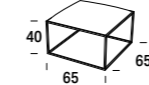

Art. 03

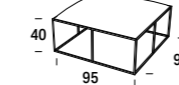

NEMESI COFFEE TABLE



Art. 01

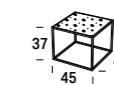

Art. 02

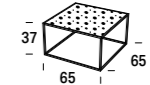

Art. 03

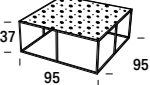

Art. 04

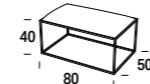

Art. 05

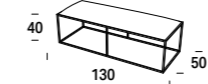

Art. 04

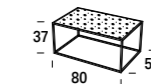

Art. 05

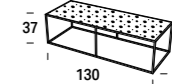

Art. 06

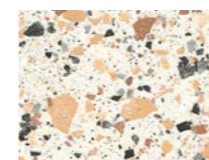
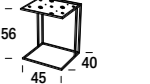

Venice



Calacatta

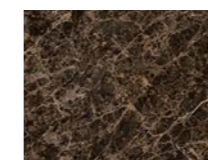

Emperador

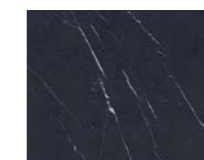

Marquinia

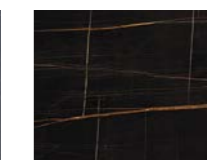

Sahara noir

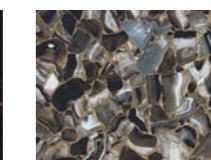

Agata black



Wave Glass

Nemo

COMPLETAMENTE SFODERABILE / COMPLETELY REMOVABLE FABRIC COMPLÈTEMENT DÉHOUSSABLE / VOLLSTÄNDIG ENTFERNBAR

STRUTTURA

Realizzata con masselli portanti in legno di abete massiccio di vari spessori, parti di tamponamento in fibra grezza e/o compensato di legno. Fianchi in agglomerato di legno da 18 mm. Il tutto è in classe E1, pertanto a bassa emissione di formaldeide. Il tutto rivestito con resinato 200 gr termoaccoppiato a vellutino in fibra di poliestere 100%.

IMBOTTITURA

Cuscino seduta in poliestere espanso indeformabile D.35 SR, il tutto rivestito con falda termolegata da 300 gr. Schienale e braccioli in espanso indeformabile D.30 S. Tamponi esterni in espanso indeformabile in varie densità D.21. Lastra interna poggiatesta in D.18 M, il tutto rivestito con falda termolegata da 300 gr.

MOLLEGGIO

Realizzato con nastri elastici da 80 mm tesi meccanicamente, composti da fili di gomma ricoperti da filo di nylon avvolto a spirale.

PIEDI

Piedi H150 mm in metallo pressofuso. Finitura: Nero Opaco.

FRAME

Supporting frame made of solid fir wood of various thicknesses, reinforcement parts produced from wood fibre and/or plywood. 18 mm particleboard sides. All in Class E1, therefore with low formaldehyde emissions. All covered with 200 g resin thermo-bonded to 100% polyester fibre velveteen.

PADDING

Seat cushion in non-deformable expanded polyester D.35 SR, all covered with heat-bonded layer 300 gr. Backrest and armrests in non-deformable foam D.30 S. External buffers in non-deformable foam in various densities D.21. Inner plate rests in D.18 M, all covered with thermo-bonded layer of 300 gr.

SPRINGING

Made of 80 mm wide mechanically tensioned webbing composed of nylon strands wound into a spiral.

FEET

H150 mm die-cast metal feet. Finish: Matt Black.

STRUCTURE

Réalisée en bois massif de pin portant de différentes épaisseurs. Fileurs de remplissage en fibre brute et/ou contreplaqué. Côtés en aggloméré de bois et/ou multicouches de bois 18 mm. Fibre brute et aggloméré de bois en Classe E1, donc à basse émission de formaldéhydes. Le châssis est revêtu par du velours 100% polyamine couplé à chaud à de l'ouate résinée de 200 gr. 100% polyester.

REMOUVRAGE

Coussin d'assise en polyester expansé indéformable D.35 SR, le tout recouvert d'une couche thermoliée de 300 gr. Dossier et accoudoirs en mousse indéformable D.30 S. Tampons externes en mousse indéformable en différentes densités D.21. Plaque interne repose-reins en D.18 M, le tout recouvert d'une couche thermoliée de 300 gr.

SUSPENSION

Réalisée avec des bandes élastiques de 80 mm tendues mécaniquement, composées par des fils de gomme recouverts par du fil de nylon enroulé à spirale.

PIEDS

Pieds H150 mm en métal moulé sous pression. Finition: Noir Mat.

KORPUS

Aus massivem Tannenholz in verschiedenen Stärken, Füllungen aus Rohfaser und/oder Sperrholz. Seiten aus 18 mm Spanplatte. Alles entspricht der Klasse E1, also mit geringer Formaldehydabgabe. All dies ist mit Samt aus 100% Polyamid bezogen, der mit Schaumstoff und/oder geharztem Material zu 200 g heiß aufkaschiert wurde, der bzw. das wiederum auf Samt aus 100% Polyesterfaser heiß aufkaschiert wurde.

POLSTERUNG

Sitzkissen aus formstabilem Polyesterschaumstoff D.35 SR, das mit einer wärmegebundenen Schicht zu 300g versehen ist. Rückenlehne und Armlehnen aus formstabilem Schaumstoff D.30 S., Außenpolster aus formstabilem Schaumstoff in verschiedenen Dichten D.21. Interne Lendenwirbelstütze in D.18 M, verkleidet mit einer wärmegebundenen Schicht zu 300g.

FEDERUNG

Besteht aus elastischen, mechanisch gespannten 80mm breiten Gurten, die aus Gummifäden bestehen, die mit spiralförmig gewickelten Nylonfäden ummantelt sind.

FÜSSE

Füsse H150 mm aus druckgegossenem Metall. Finish: Mattschwarz.

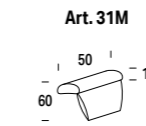
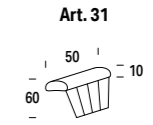
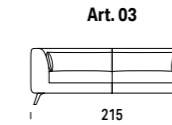
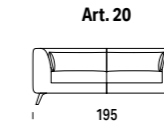
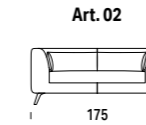
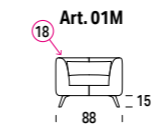
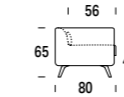
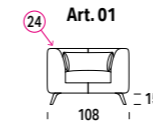
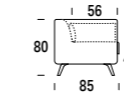

VARIANTE STANDARD CON SUPPORTO LOMBARE AMOVIBILE
STANDARD VERSION WITH REMOVABLE LUMBAR SUPPORT
VARIANTE STANDARD AVEC SUPPORT LOMBAIRE AMOVIBLE
STANDARD AUSFÜHRUNG MIT ABNEHMBARER LENDENWIRBELSTÜTZE



OPTIONAL CON POGGIATESTA
OPTIONAL WITH HEADREST
OPTION AVEC APPUI-TÊTE
OPTIONAL MIT KOPFSTÜTZE



Pantheon

COMPLETAMENTE SFODERABILE / COMPLETELY REMOVABLE FABRIC COMPLÈTEMENT DÉHOUSSABLE / VOLLSTÄNDIG ENTFERNBAR

STRUTTURA

Struttura realizzata con masselli portanti in legno di abete massiccio di vari spessori, parti di tamponamento in fibra grezza e/o compensato. Fianchi in agglomerato di legno e/o multistrato di legno da 18 mm. Fibra grezza e agglomerato di legno in classe E1, pertanto a bassa emissione di formaldeide. Il telaio è rivestito con resinato da 200 gr. termoaccoppiato a vellutino 100% poliestere.

IMBOTTITURA

Seduta in poliuretano espanso indeformabile D45 SR. Schienale e braccioli in espanso indeformabile D18 SS.

MOLLEGGIO

Realizzato con nastri elastici da 80 mm tesi meccanicamente, composti da fili di nylon avvolti a spirale.

PIEDI

Piedi in ABS nero da H 40 mm, non visibili.

FRAME

Made of solid fir wood in various thicknesses. Reinforcement parts in wood fibre and/or plywood. Sides made of 18 mm particleboard and/or multilayered wood. Wood fibre and particleboard Class E1 therefore low formaldehyde emissions. The frame is covered with 200 gr resinat, thermos-coupled to 100% polyester velveteen.

PADDING

Seat made of non-deformable polyurethane foam D45 SR. Backrest and armrests made of non-deformable foam D18 SS.

SPRINGING

Made of 80 mm wide mechanically tensioned webbing composed of nylon strands wound into a spiral.

FEET

Black ABS plastic feet H 40 mm, not visible.

STRUCTURE

Réalisée en bois massif de sapin portant de différentes épaisseurs. Fileurs de remplissage en fibre brute et/ou contreplaqué. Côtés en aggloméré de bois et/ou multicouches de bois 18 mm. Fibre brute et aggloméré de bois en Classe E1, donc à basse émission de formaldéhydes. Le châssis est revêtu par du velours 100% polyamide couplé à chaud à de l'ouate résinée de 200 gr. 100% polyester.

REMBOURRAGE

Assise en expansé indéformable de polyuréthane D45 SR. Dossier et accoudoirs en expansé flexible et indéformable de polyuréthane D18 SS.

SUSPENSION

Réalisée avec des bandes élastiques de 80 mm tendues mécaniquement, composées par des fils de gomme recouverts par du fil de nylon enroulé à spirale.

PIEDS

Pieds en ABS noir H. 40 mm, non visibles.

KORPUS

Aufbau aus massivem Tannenholz in verschiedenen Stärken, Füllungen aus Rohfaser und/oder Sperrholz. Seiten aus 18 mm Spanplatte. Alles entspricht der Klasse E1, also mit geringer Formaldehydabgabe. Der Rahmen ist mit 200 gr Resinat überzogen, das mit 100% Polyester Samt verbinden ist.

POLSTERUNG

Der Sofasitz besteht aus unverformbarem Polyurethanschaum D45 SR. Rückenlehne und Armlehnen bestehen aus Polyurethanschaum D18SS.

FEDERUNG

Hergestellt aus mechanisch gedehnten 80-mm-Elastikbändern, bestehend aus spiralförmig gewickelten Nylonfäden.

FÜSSE

Füße aus schwarzem ABS H. 40mm nicht sichtbar.

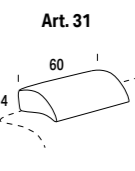
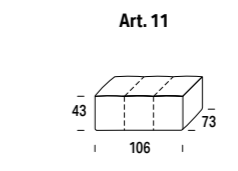
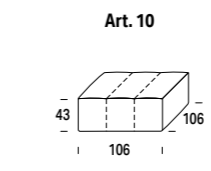
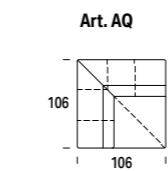
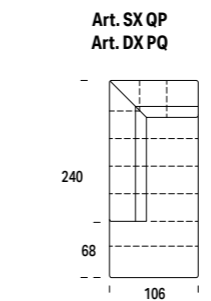
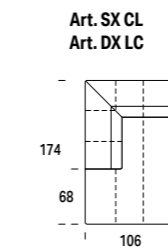
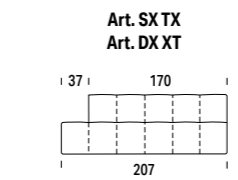
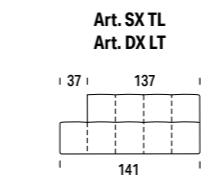
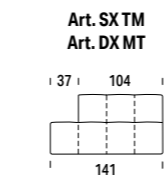
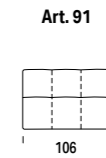
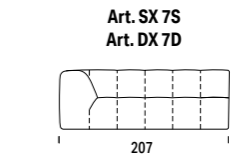
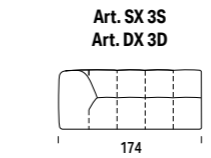
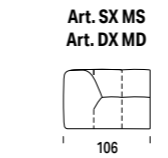
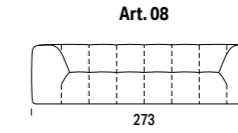
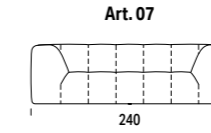
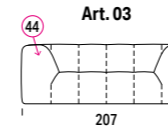
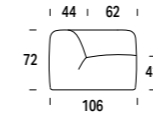
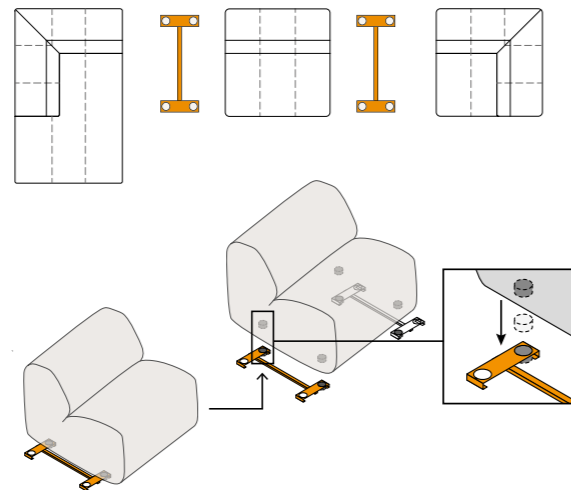

ESEMPI COMPOSITIVI / COMPOSITION EXAMPLES / EXEMPLES DE COMPOSITION / KOMPOSITORISCHE BEISPIELE

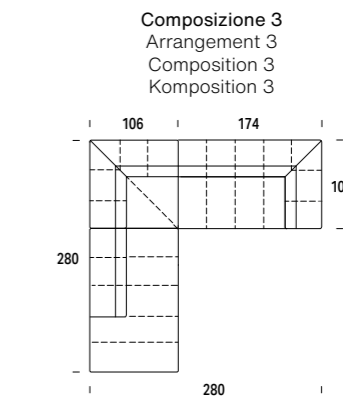
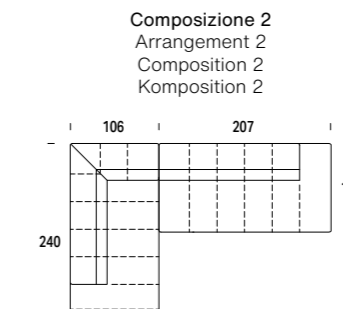
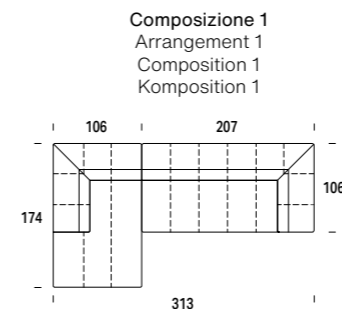

Pills

COMPLETAMENTE SFODERABILE / COMPLETELY REMOVABLE FABRIC COMPLÈTEMENT DÉHOUSSABLE / VOLLSTÄNDIG ENTFERNBAR

STRUTTURA

Pannello in multistrato di pino e/o abete e/o pioppo da 25 mm con predisposizione bossole per l'applicazione di piedi in metallo. Il tutto trattato al naturale in classe E1, pertanto a bassa emissione di formaldeide. Il telaio è completamente rivestito con vellutino 100% poliammine termoaccoppiato a ovatta resinato da 200 gr di 100% poliesteri.

IMBOTTITURA

Seduta: lastra in poliuretano espanso flessibile e indeformabile in densità D30TL fresato tondo sul perimetro, totalmente rivestito in vellutino in poliammine 100% accoppiato a falda di resinato in poliesteri da 200 gr. I materiali corrispondono alle normative europee 91/156/etc. Informazioni ambientali sulla sicurezza: la deperibilità del prodotto, secondo la sua composizione, è praticamente nulla. Le resine non sono contenute nella lista della normativa di classificazione dei rifiuti per materiali soggetti a particolare sorveglianza. Le resine espansive sono esenti da freon e solventi clorurati. Le resine espansive non contengono sostanze che danneggiano l'ozonosfera e non vengono fabbricate con prodotti menzionati nel protocollo di Montreal e Regolamento (CE) n. 3093/94.

PIEDINI

Piedini in metallo saldati e levigati a mano disponibili in quattro diverse finiture a bagno di galvanica.

FRAME

Panel made of 25 mm pine and/ or fir and/ or poplar multilayered wood ready for metal feet to be fitted. All treated naturally in Class E1, thus with low formaldehyde emissions. The frame is completely covered with 100% polyamines velveteen thermo-bonded to 200 g. 100% polyester wadding resin.

PADDING

Seat: sheet of flexible, and nondeformable polyurethane foam, D30TL density, milled around the perimeter, completely covered with 100% polyamine velveteen bonded to a layer of 200g polyester resin. The materials meet European standards 91/156/ etc. Environmental information on safety: the perishability of the product, based on its composition, is practically nil. Resins are not included in the list of standards for the classification of waste materials subject to special monitoring. Resin foams are free from freon and chlorinated solvents. Resin foams do not contain substances that damage the ozone layer and are not manufactured using products mentioned in the Montreal Protocol and (CE) Regulation no. 3093/94.

FEET

Welded and hand polished metal feet, available in four different electroplated finishes.

STRUCTURE

Panneau stratifié en pin et/ ou sapin et/ ou peuplier de 25 mm avec prédisposition pour l'application des pieds en métal. Le tout traité au naturel en classe E1, soit à faible émission de formaldéhydes. Le cadre est entièrement recouvert de velours 100% polyamines couplé à chaud à de la ouate résinée de 200 g 100% polyester.

REBOURRAGE

Siège: plaque en mousse de polyuréthane souple et indéformable densité D30TL fraisée ronde sur le pourtour et totalement recouverte de velours 100% polyamines couplé à chaud à une couche de résine de polyester de 200 g. Les matériaux sont conformes aux normes européennes 91/156/ etc Informations environnementales sur la protection: la nature périssable du produit, sur la base de sa composition, est pratiquement nulle. Les résines ne figurent pas dans la liste établie par la norme de classification des déchets de matériaux soumis à une surveillance particulière. Les résines expansées ne contiennent pas de fréon ni de solvants chlorés. Les résines expansées ne contiennent pas de substances nuisibles à la couche d'ozone et ne sont pas fabriquées avec des produits figurant dans le Protocole de Montréal et le Règlement (CE) n° 3093/94.

PIEDS

Pieds en métal soudés et polis à la main disponibles en quatre finitions galvanisées.

KORPUS

25mm Sperrholzplatte aus Kiefer und/oder Fichte und/oder Pappel mit Vorbereitung von Hülsen zur Anbringung der Metallfüße. Alles wurde natürlich behandelt und entspricht der Klasse E1, also mit geringer Formaldehydabgabe. Der Rahmen ist komplett mit 100% Polyamid-Samt bezogen, der auf gehartzte Watte zu 200g aus 100% Polyester heiß aufkaschiert ist.

POLSTERUNG

Sitzfläche: formbeständiger, elastischer Polyurethanschäumkern mit einer Dichte von D30TL, rundum gefräst, vollständig mit 100% Polyamidsamt bezogen, der auf Polyesterharzwatte zu 200g aufkaschiert ist. Die Materialien entsprechen den europäischen Normen 91/156/ etc. Hinweise zur Umweltsicherheit: Die Verderblichkeit des Produkts ist aufgrund seiner Zusammensetzung praktisch gleich Null. Die Schaumstoffe/ Harze sind nicht in der Liste der Abfallklassifizierungsvorschriften für besonders überwachungsbedürftige Stoffe aufgeführt. Die Schaumstoffe sind frei von Freon und chlorierten Lösungsmitteln. Die Schaumstoffe enthalten keine Substanzen, welche die Ozonschicht schädigen, und werden nicht mit Produkten hergestellt, die im Montrealer Protokoll und der Verordnung (EG) Nr. 3093/94 genannt sind.

FÜSSE

Die Metallfüße sind geschweißt und von Hand poliert, sowie in vier verschiedenen Ausführungen (Galvanobad) erhältlich.

Art. 15

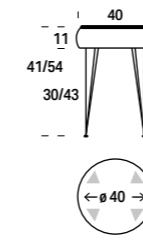

Piano rotondo ø 40 cm / 4 gambe
Round top ø 40 cm / 4 legs
Plateau rond ø 40 cm / 4 pieds
Runde Platte ø 40 cm / 4 Füße



Gambe cromo
Cromo legs
Pieds chromés
Chrom Füße



Gambe oro
Gold legs
Pieds or
Gold Füße



Gambe carbon look
Carbon look legs
Pieds look carbone
Carbon-Look Füße



Gambe rame
Copper legs
Pieds cuivre
Kupfer Füße

Art. 16

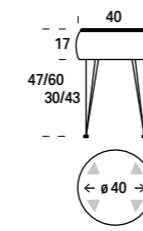

Piano rotondo ø 40 cm / 4 gambe
Round top ø 40 cm / 4 legs
Plateau rond ø 40 cm / 4 pieds
Runde Platte ø 40 cm / 4 Füße



Gambe cromo
Cromo legs
Pieds chromés
Chrom Füße



Gambe oro
Gold legs
Pieds or
Gold Füße



Gambe carbon look
Carbon look legs
Pieds look carbone
Carbon-Look Füße



Gambe rame
Copper legs
Pieds cuivre
Kupfer Füße

Art. 17

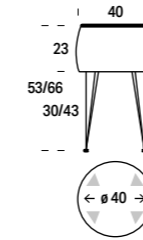

Piano rotondo ø 40 cm / 4 gambe
Round top ø 40 cm / 4 legs
Plateau rond ø 40 cm / 4 pieds
Runde Platte ø 40 cm / 4 Füße



Gambe cromo
Cromo legs
Pieds chromés
Chrom Füße



Gambe oro
Gold legs
Pieds or
Gold Füße



Gambe carbon look
Carbon look legs
Pieds look carbone
Carbon-Look Füße



Gambe rame
Copper legs
Pieds cuivre
Kupfer Füße

SPECIFICARE COLORE DEL BORDO (IN TINTA O CONTRASTO)
SPECIFY COLOUR OF TRIM (SAME OR CONTRASTING COLOUR)
SPECIFIER LA COULEUR DU PASSPOIL (MEME COULEUR OU EN CONTRASTE)
FARBE DER KANTE ANGEBEN (TON-IN-TON ODER FARBLICH ABGESETZT)

FINITURE GAMBE
LEG FINISHES
FINITIONS PIEDS
AUSFÜHRUNG DER FÜSSE



H. 30/43
Cromo
Chrome
Chrome
Chrom
Oro
Gold
Or
Gold
Rame
Copper
Cuivre
Kupfer
Carbon look lucido
Shining carbon look
Look carbone brillant
Carbon - Look Hochglanz

Art. 18

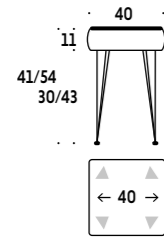

Piano quadrato 140 cm / 4 gambe
 Square top 140 cm / 4 legs
 Plateau carré 140 cm / 4 pieds
 Quadratische Platte B 40 cm / 4 Füße



Gambe cromo
 Cromo legs
 Pieds chromés
 Chrom Füße



Gambe oro
 Gold legs
 Pieds or
 Gold Füße



Gambe carbon look
 Carbon look legs
 Pieds look carbone
 Carbon-Look Füße



Gambe rame
 Copper legs
 Pieds cuivre
 Kupfer Füße

Art. 19

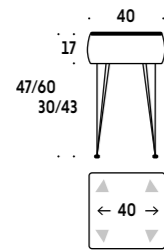

Piano quadrato 140 cm / 4 gambe
 Square top 140 cm / 4 legs
 Plateau carré 140 cm / 4 pieds
 Quadratische Platte B 40 cm / 4 Füße



Gambe cromo
 Cromo legs
 Pieds chromés
 Chrom Füße



Gambe oro
 Gold legs
 Pieds or
 Gold Füße



Gambe carbon look
 Carbon look legs
 Pieds look carbone
 Carbon-Look Füße



Gambe rame
 Copper legs
 Pieds cuivre
 Kupfer Füße

Art. 20

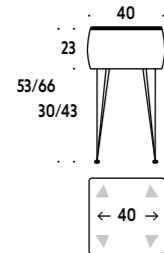

Piano quadrato 140 cm / 4 gambe
 Square top 140 cm / 4 legs
 Plateau carré 140 cm / 4 pieds
 Quadratische Platte B 40 cm / 4 Füße



Gambe cromo
 Cromo legs
 Pieds chromés
 Chrom Füße



Gambe oro
 Gold legs
 Pieds or
 Gold Füße



Gambe carbon look
 Carbon look legs
 Pieds look carbone
 Carbon-Look Füße



Gambe rame
 Copper legs
 Pieds cuivre
 Kupfer Füße

Art. 14

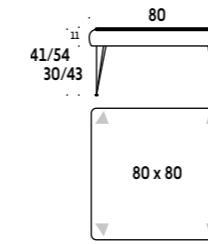

Piano rettangolare 80 x 60 cm / 4 gambe
 Rectangular top 80 x 60 cm / 4 legs
 Plan rectangulaire 80 x 60 cm / 4 pieds
 Rechteckige Platte 80 x 60 cm / 4 Füße



Gambe cromo
 Cromo legs
 Pieds chromés
 Chrom Füße



Gambe oro
 Gold legs
 Pieds or
 Gold Füße



Gambe carbon look
 Carbon look legs
 Pieds look carbone
 Carbon-Look Füße



Gambe rame
 Copper legs
 Pieds cuivre
 Kupfer Füße

Art. 13

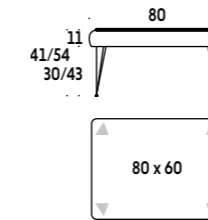

Piano quadrato 80 x 80 cm / 4 gambe
 Square top 80 x 80 cm / 4 legs
 Plateau carré 80 x 80 cm / 4 pieds
 Quadratische Platte 80 x 80 cm / 4 Füße



Gambe cromo
 Cromo legs
 Pieds chromés
 Chrom Füße



Gambe oro
 Gold legs
 Pieds or
 Gold Füße



Gambe carbon look
 Carbon look legs
 Pieds look carbone
 Carbon-Look Füße



Gambe rame
 Copper legs
 Pieds cuivre
 Kupfer Füße

Art. 21

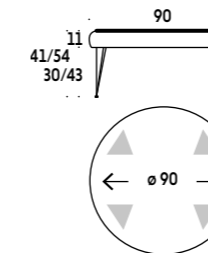

Piano rotondo ø 90 cm / 4 gambe
 Round top ø 90 cm / 4 legs
 Plateau rond ø 90 cm / 4 pieds
 Runde Platte ø 90 cm / 4 Füße



Gambe cromo
 Cromo legs
 Pieds chromés
 Chrom Füße



Gambe oro
 Gold legs
 Pieds or
 Gold Füße



Gambe carbon look
 Carbon look legs
 Pieds look carbone
 Carbon-Look Füße



Gambe rame
 Copper legs
 Pieds cuivre
 Kupfer Füße

Art. 12

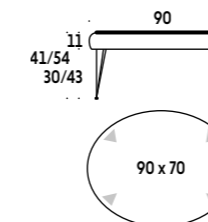

Piano ovale 90 x 70 cm / 4 gambe
 Oval top 90 x 70 cm / 4 legs
 Plan oval 90 x 70 / 4 pieds
 Ovale Platte 90 x 70 cm / 4 Füße



Gambe cromo
 Cromo legs
 Pieds chromés
 Chrom Füße



Gambe oro
 Gold legs
 Pieds or
 Gold Füße



Gambe carbon look
 Carbon look legs
 Pieds look carbone
 Carbon-Look Füße



Gambe rame
 Copper legs
 Pieds cuivre
 Kupfer Füße

Platform

COMPLETAMENTE SFODERABILE / COMPLETELY REMOVABLE FABRIC COMPLÈTEMENT DÉHOUSSABLE / VOLLSTÄNDIG ENTFERNBAR

STRUTTURA

Sedute realizzate con pannelli in multistrato da 18mm rinforzate con masselli portanti in legno di abete massiccio vario spessore. Schiene realizzate in agglomerato di legno da 18mm. Il tutto in classe E1, pertanto a bassa emissione di formaldeide.

FRAME

Seats made from 18 mm multi-layered panels reinforced with solid fir wood supporting frame of various thicknesses. Backs made of 18mm particleboard. All in Class E1, therefore with low formaldehyde emissions.

STRUCTURE

Assises réalisées avec des panneaux en multicouches de 18mm renforcées par du pin massif portant d'épaisseur variable. Dossiers réalisés en bois aggloméré de 18mm. Le tout en classe E1, donc à basse émission de formaldéhyde.

KORPUS

Sitzflächen aus 18mm Sperrholzplatten, verstärkt mit Massivholz aus Tanne als tragendes Element in verschiedenen Stärken. Rückenlehnen aus 18 mm Spanplatte. Alles entspricht der Klasse E1, also mit geringer Formaldehydabgabe.

IMBOTTITURA

Sedute in espanso indeformabile 30SR ricoperto con resinato da 200 gr. accoppiato a maglina 100% poliestere. Schiene in espanso indeformabile FEE21 ricoperto con resinato da 200 gr. accoppiato a maglina 100% poliestere. Cuscini schiena in "pelle d'uovo", cotone, poliestere a camere separate riempite con misto piuma sterilizzata e fiocco di poliestere vergine 100%.

PADDING

Seats made of 30SR non-deformable foam covered with 200 g resin bonded to 100% polyester jersey. Backs made of FEE21 non-deformable foam covered with 200 g resin bonded to 100% polyester jersey. Muslin back cushions made of cotton and polyester in separate chambers stuffed with sterilised mixed feather padding and 100% virgin polyester flock.

REMOURRAGE

Assises en espanso indéformable 30SR recouvert par 200gr de résiné accouplé à une petite maille 100% polyester. Dossiers en espanso indéformable FEE21 recouvert par 200gr de résiné accouplé à une petite maille 100% polyester. Coussins du dossier en "peau d'œuf", coton, polyester à chambres séparées rembourrées par un mixte de plume stérilisée et de flocon de polyester 100% vierge.

POLSTERUNG

Sitzflächen aus formstabilem Schaumstoff in 30SR, bezogen mit gehärtetem Material zu 200g, auf das 100% Polyester-Jersey aufkaschiert ist. Rückenlehnen aus formstabilem Schaumstoff in FEE21, bezogen mit gehärtetem Material zu 200g, auf das 100% Polyester-Jersey aufkaschiert ist. Rückenkissen mit Musselinbezug, Baumwolle, Polyester, mit getrennten Kammern, die mit sterilisierten Federn und 100% Polyester-Stapelfaser gefüllt sind.

PIEDI

Piedi in ABS nero H40mm non visibile.

FEET

Black ABS feet H40 mm not visible.

PIEDS

Pieds en ABS noir H. 40mm non visible.

FÜSSE

40mm hohe Füße aus nicht sichtbarem ABS in Schwarz.

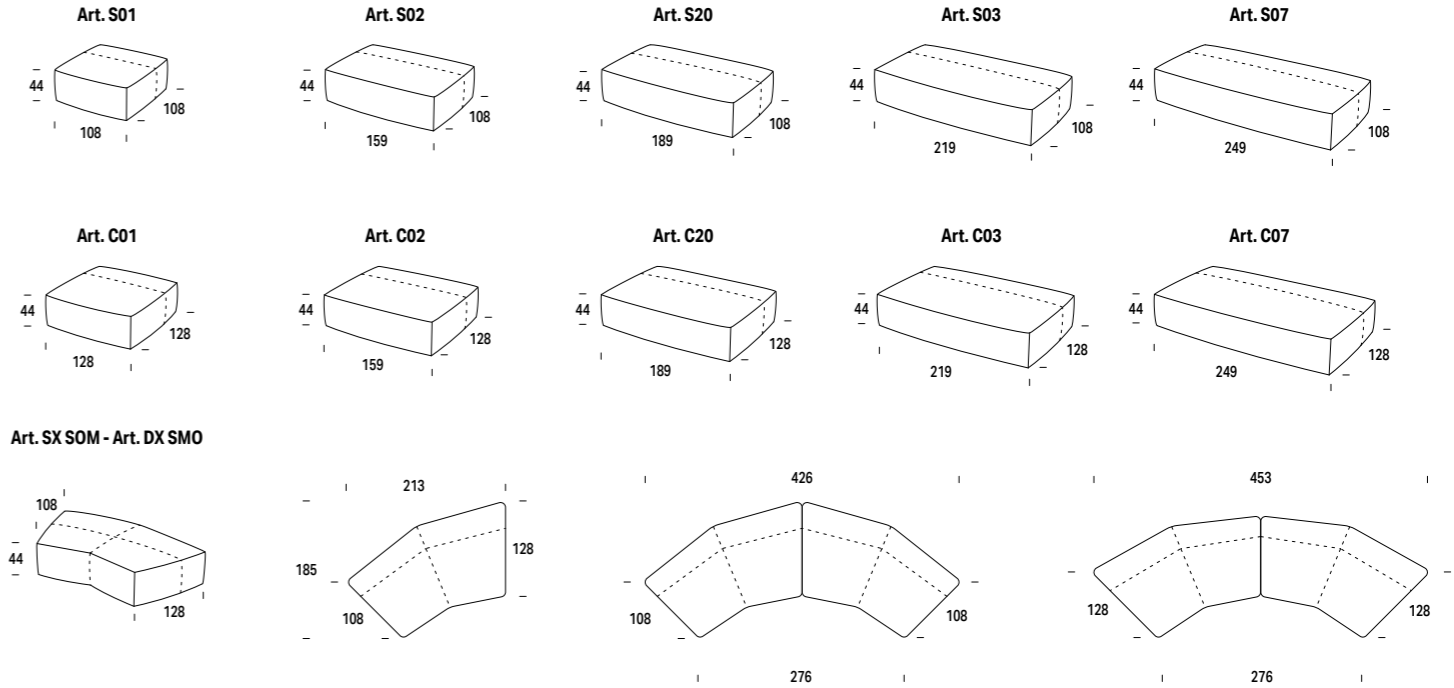

Tutti gli elementi sono rifiniti in ogni parte, in modo da poter essere utilizzati sia in composizione sia singolarmente.
 All the elements are finished in all parts so that they can be used both jointly or individually.
 Tous les éléments sont finis de tous les côtés, de façon à être utilisés que ce soit en composition que séparément.
 Alle Elemente sind komplett fertiggestellt, so dass sie sowohl in Kombinationen als auch einzeln verwendet werden können.

Modalità di aggancio degli elementi.
 Coupling system method.
 Modalité d'accrochage des éléments.
 Verbindungsmodus der Elemente.

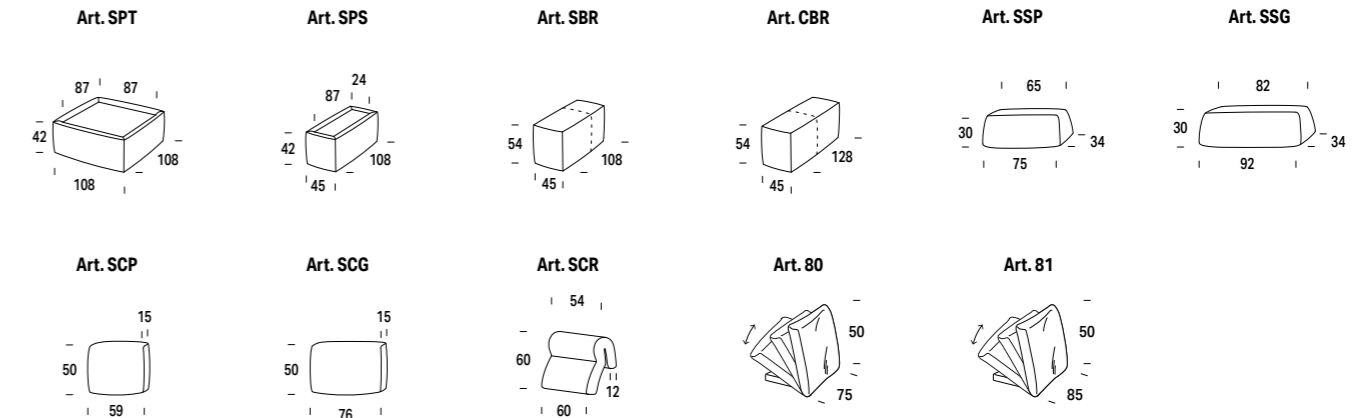
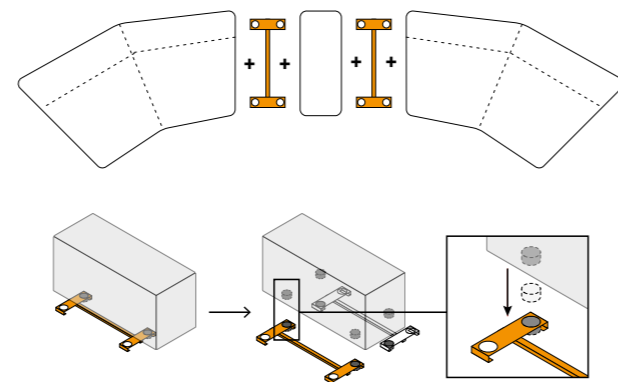

ESEMPI COMPOSITIVI / COMPOSITION EXAMPLES / EXEMPLES DE COMPOSITION / KOMPOSITORISCHE BEISPIELE

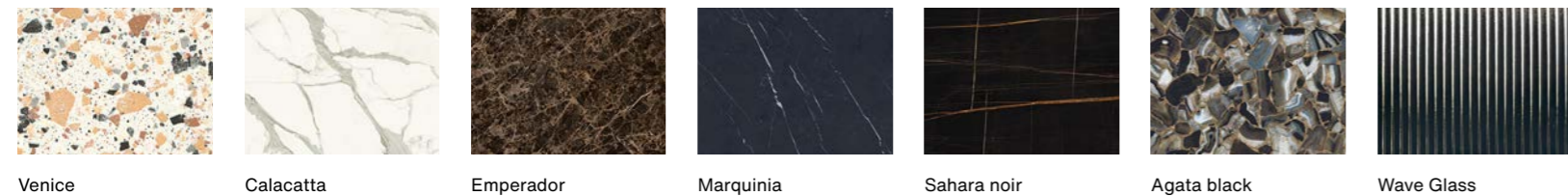
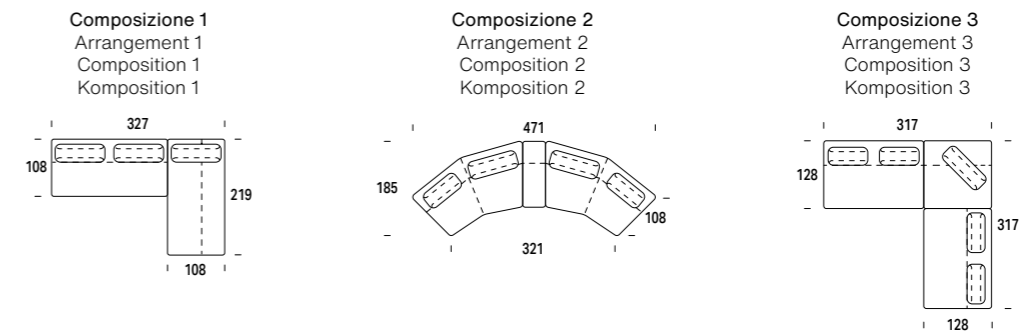

Prince

COMPLETAMENTE SFODERABILE / COMPLETELY REMOVABLE FABRIC COMPLÈTEMENT DÉHOUSSABLE / VOLLSTÄNDIG ENTFERNBAR

STRUTTURA

Realizzata in agglomerato di legno di spessore 10mm. Il tutto trattato al naturale in classe E1, pertanto a bassa emissione di formaldeide. Polistirolo espanso in densità 10N.

IMBOTTITURA

Seduta: lastra in poliuretano espanso flessibile e indeformabile in densità D30HS fresato tondo sul perimetro. Parti di tamponamento perimetrale: lastre sagomate di poliuretano indeformabile in D16S. Falda termolegata da 300 gr/mq in ovatta di poliestere 100 %. Il tutto rivestito con poliuretano accoppiato a maglia resinata da 200g 100 % poliestere. I materiali corrispondono alle normative europee 91/156/etc. Informazioni ambientali sulla sicurezza: la deperibilità del prodotto, secondo la sua composizione, è praticamente nulla. Le resine non sono contenute nella lista della normativa di classificazione dei rifiuti per materiali soggetti a particolare sorveglianza. Le resine espanse sono esenti da freon e solventi clorurati. Le resine espanse non contengono sostanze che danneggiano l'ozonofera e non vengono fabbricate con prodotti menzionati nel protocollo di Montreal e Regolamento (CE) n. 3093/94.

PIEDINI

Piedini in ABS nero da 20mm.

FRAME

Made of 10mm thick particleboard. All treated naturally in class E1, therefore with low formaldehyde emissions. 10N density polystyrene foam.

PADDING

Seat: flexible non-deformable D30HS density polyurethane foam sheet with round milled perimeter. Perimeter reinforcement parts: shaped D16S non-deformable polyurethane sheets. Thermo-bonded layer 100 % polyester wadding 300 g/sq. m. All covered with polyurethane bonded to 200 g 100% polyester resin jersey. Materials comply with European regulations 91/156/ etc. Environmental safety information: product perishability, according to its composition, is practically zero. Resins are not on the waste classification regulations list for materials subject to special supervision. Resin foams are free from Freon and chlorinated solvents. Resin foams do not contain substances that damage the ozone layer and are not manufactured using substances mentioned in the Montreal Protocol or Council Regulation (EC) No 3093/94.

FEET

20mm black ABS feet.

STRUCTURE

Réalisée en bois aggloméré épaisseur 10 mm. Le tout traité au naturel en classe E1, pour autant à basse émission de formaldéhyde. Polystyrène expansé en densité 10N.

REMOUVRAGE

Assise : plaque en polyuréthane expansé flexible et indéformable densité D30HS fraisé arrondi sur le périmètre. Parties de remplissage périmétrale : plaques modelées en polyuréthane indéformable en D16S. Bord thermo-lié de 300gr./m² en 100% ouate de polyester. Le tout revêtu par du polyuréthane accouplé à 200 gr. de maille résinée 100% polyester. Les matériaux correspondent aux normes européennes 91/156/etc. Informations environnementales sur la sécurité : la nature périssable du produit, selon sa composition, est pratiquement nulle. Les résines ne font pas parties de la liste de la normative de classification des déchets de matériaux sujets à une surveillance particulière. Les résines expansées sont exemptes de fréon et de solvants chlorurés. Les résines expansées ne contiennent pas de substances qui endommagent la couche d'ozone et ne sont pas fabriquées avec des produits mentionnés dans le protocole de Montréal et le Règlement (CE) n° 3093/94.

PIEDS

Pieds en ABS de 20 mm.

KORPUS

Aus Spanholz hergestellt, mit Stärke 10 mm. Alles wurde natürlich behandelt und entspricht Klasse E, d.h. mit geringer Formaldehydabgabe. Polystyrol aufgeschäumt mit einer Dichte von 10N.

POLSTERUNG

Sitzfläche: formbeständiger, elastischer Polyurethanschäumkern mit einer Dichte von D30HS, rundum gefräst. Umlaufende Polsterung aus formstabilem Polyurethan in D16S. Wärmegebundene Schicht zu 300g/qm aus 100% Polyesterwatte. Das Ganze ist mit Polyurethan verkleidet, der auf geharzte Watte zu 200g aus 100% Polyester aufkaschiert ist. Die Materialien entsprechen den europäischen Normen 91/156/ etc. Hinweise zur Umweltsicherheit: Die Verderblichkeit des Produkts ist aufgrund seiner Zusammensetzung praktisch gleich Null. Die Schaumstoffe/ Harze sind nicht in der Liste der Abfallklassifizierungsvorschriften für besonders überwachungsbedürftige Stoffe aufgeführt. Die Schaumstoffe sind frei von Freon und chlorierten Lösungsmitteln. Die Schaumstoffe enthalten keine Substanzen, welche die Ozonschicht schädigen, und werden nicht mit Produkten hergestellt, die im Montrealer Protokoll und der Verordnung (EG) Nr. 3093/94 genannt sind.

FÜSSE

Füsse aus schwarzem ABS zu 20 mm.

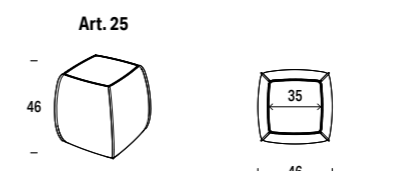
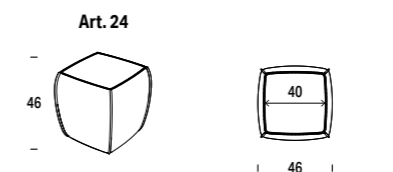
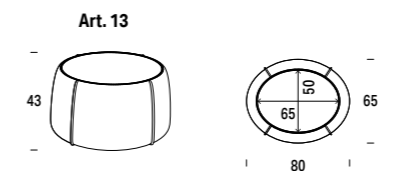
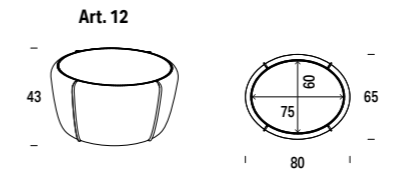
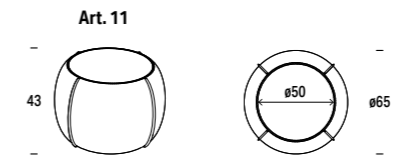
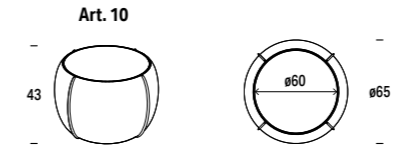

Cordoncino in tinta o a contrasto

Piping in same or contrasting colour
Cordonnet en teinte ou en contraste
Bordüre Ton-in-Ton oder farblich abgesetzt

N.B.

Il filato della cucitura seguirà la tinta del bordo
The thread used for the stitching will follow the colour of the trim
Le fil de la couture suivra la teinte du bord
Nähgarn in der gleichen Farbe wie die Kante

Reverso

COMPLETAMENTE SFODERABILE / COMPLETELY REMOVABLE FABRIC COMPLÈTEMENT DÉHOUSSABLE / VOLLSTÄNDIG ENTFERNBAR

STRUTTURA

Sedute realizzate con pannelli in multistrato da 18mm rinforzate con masselli portanti in legno di abete massiccio vario spessore.
Schiene realizzate in agglomerato di legno da 18mm.
Il tutto in classe E1, pertanto a bassa emissione di formaldeide.

FRAME

Seats made from 18 mm multilayered panels reinforced with solid fir wood supporting frame of various thicknesses.
Backs made of 18mm particleboard.
All in Class E1, therefore with low formaldehyde emissions.

STRUCTURE

Assises réalisées avec des panneaux en multicouches de 18mm renforcées par du pin massif portant d'épaisseur variable.
Dossiers réalisés en bois aggloméré de 18mm.
Le tout en classe E1, donc à basse émission de formaldéhyde.

KORPUS

Sitzflächen aus 18mm Sperrholzplatten, verstärkt mit Massivholz aus Tanne als tragendes Element in verschiedenen Stärken.
Rückenlehnen aus 18 mm Spanplatte.
Alles entspricht der Klasse E1, also mit geringer Formaldehydabgabe.

IMBOTTITURA

Sedute in espanso indeformabile 30SR ricoperto con resinato da 200 gr. accoppiato a maglia 100% poliestere.
Schiene in espanso indeformabile FEE21 ricoperto con resinato da 200 gr. accoppiato a maglia 100% poliestere.
Cuscini schiena in "pelle d'uovo", cotone, poliestere a camere separate riempite con misto piuma sterilizzata e fiocco di poliestere vergine 100%.

PADDING

Seats made of 30SR nondeformable foam covered with 200 g resin bonded to 100% polyester jersey.
Backs made of FEE21 nondeformable foam covered with 200 g resin bonded to 100% polyester jersey.
Muslin back cushions made of cotton and polyester in separate chambers stuffed with sterilised mixed feather padding and 100% virgin polyester flock.

REMOURRAGE

Assises en expansé indéformable 30SR recouvert par 200gr de résiné accouplé à une petite maille 100% polyester.
Dossiers en expansé indéformable FEE21 recouvert par 200gr de résiné accouplé à une petite maille 100% polyester.
Coussins du dossier en "peau d'œuf", coton, polyester à chambres séparées rembourrées par un mixte de plume stérilisée et de flocon de polyester 100% vierge.

POLSTERUNG

Sitzflächen aus formstabilem Schaumstoff in 30SR, bezogen mit gehartztem Material zu 200g, auf das 100% Polyester-Jersey aufkaschiert ist.
Rückenlehnen aus formstabilem Schaumstoff in FEE21, bezogen mit gehartztem Material zu 200g, auf das 100% Polyester-Jersey aufkaschiert ist.
Rückenkissen mit Musselinbezug, Baumwolle, Polyester, mit getrennten Kammern, die mit sterilisierten Federn und 100% PolyesterStapelfaser gefüllt sind.

MOLLEGGIO

Il molleggio è realizzato in nastri da 80 mm tesi meccanicamente, composti da fili di nylon avvolto a spirale.

SPRINGING

Made of 80 mm wide mechanically tensioned webbing composed of nylon strands wound into a spiral.

SUSPENSION

Réalisée avec des bandes élastiques de 80 mm tendues mécaniquement, composées par des fils de gomme recouverts par du fil de nylon enroulé à spirale.

FEDERUNG

Hergestellt aus mechanisch gedehnten 80-mmElastikbändern, bestehend aus spiralförmig gewickelten Nylonfäden.

PIEDI

Piedi in ABS nero H 40 mm non visibile.

FEET

Black ABS feet H 40 mm not visible.

PIEDS

Pieds en ABS noir H. 40mm non visible.

FÜSSE

40mm hohe Füße aus nicht sichtbarem ABS in Schwarz.

STANDARD



LUX



EASY MOVE SYSTEM

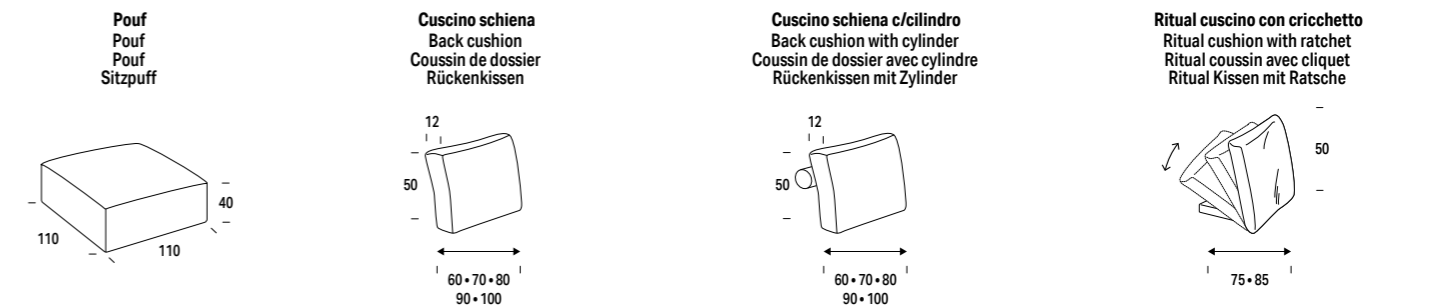
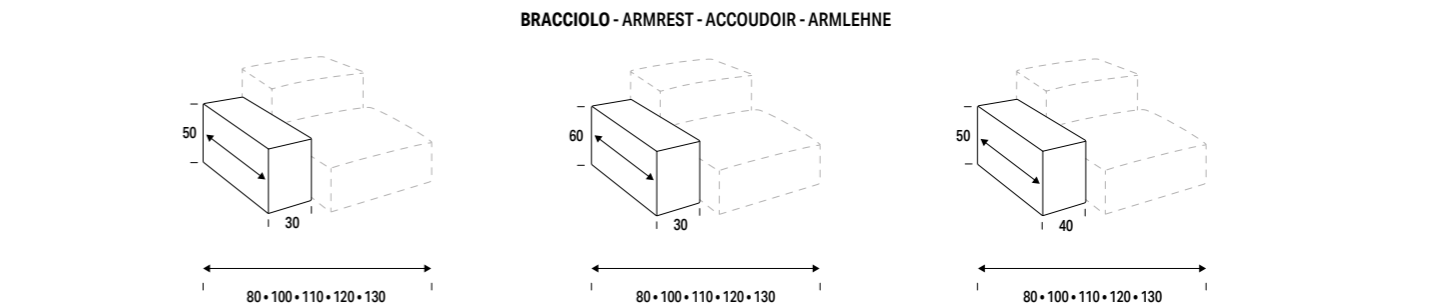
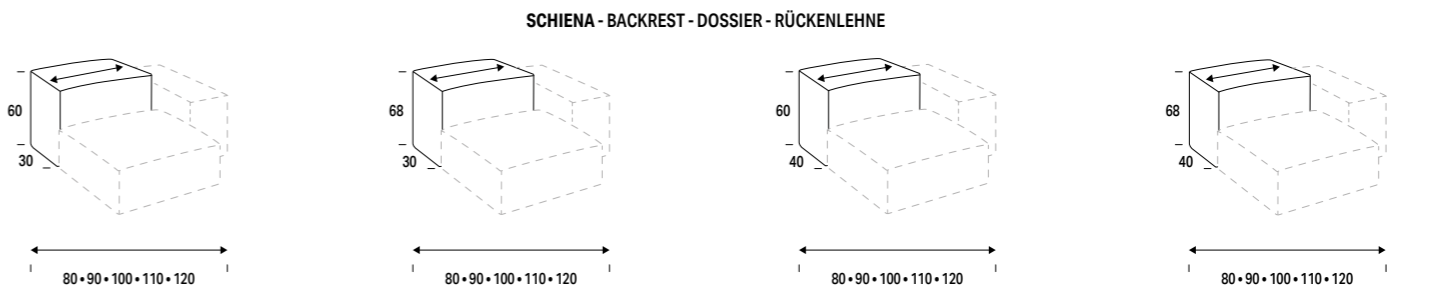
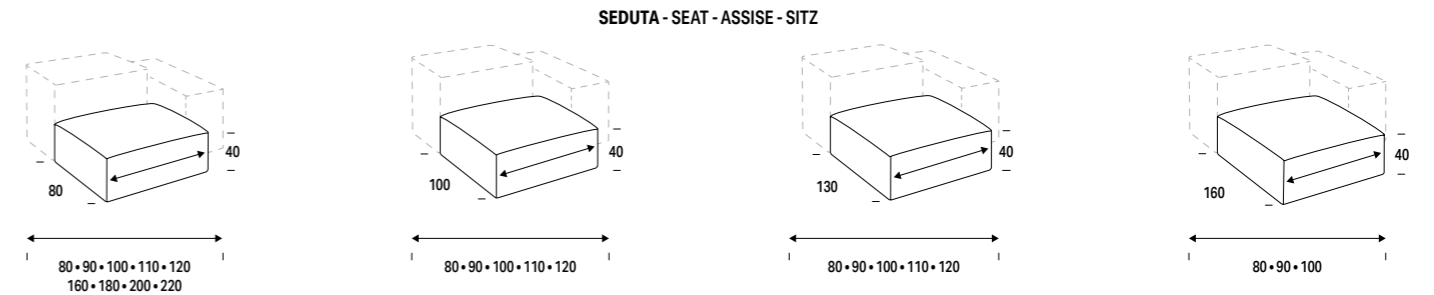
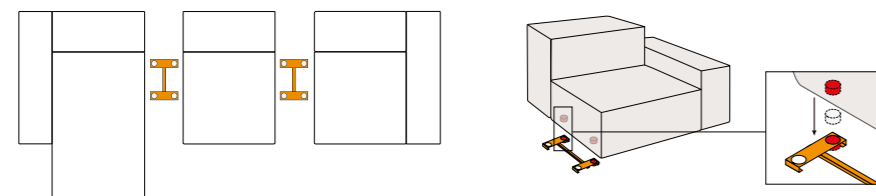

ESEMPI COMPOSITIVI / COMPOSITION EXAMPLES / EXEMPLES DE COMPOSITION / KOMPOSITORISCHE BEISPIELE

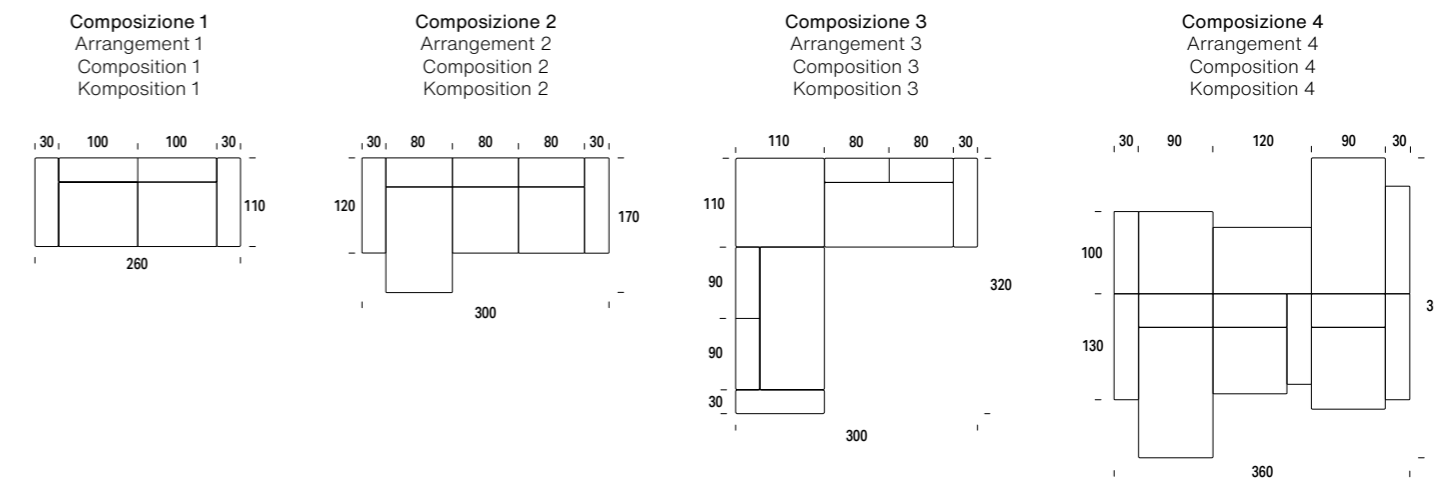

Sigmund

COMPLETAMENTE SFODERABILE / COMPLETELY REMOVABLE FABRIC COMPLÈTEMENT DÉHOUSSABLE / VOLLSTÄNDIG ENTFERNBAR

STRUTTURA

Struttura portante a pannelli in multistrato di legno da 25 mm a bassa emissione di formaldeide (classe E1), con parti in legno massello di abete e/o pioppo e pannelli di fibre di legno compresse a caldo. Il tutto rivestito con resinato da 200g accoppiato a maglina 100% poliester.

FRAME

Supporting frame made of 25 mm multi-layered wood panels with low formaldehyde emissions (class E1), with parts made of solid fir and/or poplar and hot compressed wood fibreboard panels. All covered with 200g resin bonded to 100% polyester jersey.

STRUCTURE

Structure portante de panneaux en bois multicouches de 25 mm à basse émission de formaldéhyde (classe E1), avec des parties en pin massif et/ou peuplier et panneaux de fibre de bois comprimé à chaud. Le tout revêtu par 200g. de résiné accouplé à une maille 100% polyester.

KORPUS

Tragende Struktur aus 25 mm dicken Sperrholzplatten mit geringer Formaldehyd-Emission (Klasse E1), mit Massivholzteilen aus Tanne und/oder Pappel und heißgepressten Holzfaserplatten. All das verkleidet mit geharztem Material zu 200g, auf das 100% Polyester-Jersey aufkaschiert ist.

IMBOTTITURA

Cuscini e parti di tamponamento in espanso indeformabile densità 30E.

PADDING

Cushions and reinforcement parts made from 30E density non-deformable foam.

REMBOURRAGE

Coussins et parties de remplissage en espansé indéformable densité 30E.

POLSTERUNG

Kissen und ein Teil der Polster Elemente aus formstabilem Schaumstoff mit der Dichte 30E.

PIEDI

Piedi in metallo pressofuso verniciati con polveri epossidiche e dotati di gommino antiscivolo. Disponibile nelle finiture: ottone, carbon look, rame, cromo lucido.

FEET

Die-cast metal feet with epoxy powder coating fitted with non-slip rubber pad. Available in the finishes: brass, carbon look, copper, polished chrome.

PIEDS

Pieds en métal moulé sous pression vernis aux poudres époxydiques et dotés de gomme antidérapante. Disponibles dans les finitions : laiton, look carbone, cuivre, chrome brillant.

FÜSSE

Füsse aus Metalldruckguss, mit Epoxidpulver-Beschichtung und rutschfestem Gummi versehen. In den folgenden Ausführung erhältlich: Messing, Carbon-Look, Kupfer, Chrom Hochglanz.

SIGMUND - A



Art. 1A

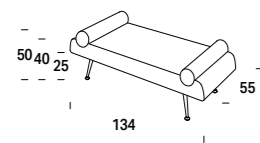

SIGMUND - B



Art. 1B

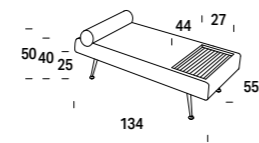

POLTRONCINA GIREVOLE

SWIVEL ARMCHAIR
FAUTEUIL PIVOTANT
DREHSESSEL



Art. 01

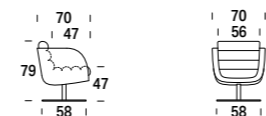

POLTRONCINA GIREVOLE DINNING

DINNING SWIVEL ARMCHAIR
FAUTEUIL PIVOTANT DINNING
DINNING DREHSESSEL



Art. 01X

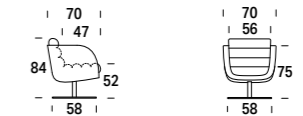

Piedini disponibili nelle finiture

Feet available in finishes / Petits pieds disponibles dans les finitions / Füsse erhältlich mit dem Finish:

PIEDE SIXTY H 25 / Sixty H 25 foot / Pied Sixty H25 / Fuss Sixty H 25



Rame / Copper
/ Cuivre / Kupfer

Carbon look

Ottone / Brass
/ Laiton / Messing

Cromo lucido / Shining chrome
/ Chrome brillant / Chrom Hochglanz

Tubes

COMPLETAMENTE SFODERABILE / COMPLETELY REMOVABLE FABRIC COMPLÈTEMENT DÉHOUSSABLE / VOLLSTÄNDIG ENTFERNBAR

STRUTTURA

Realizzata con masselli portanti in legno di abete massiccio di vari spessori. Il telaio è completamente rivestito con resinato da 200gr accoppiato a maglina di 100% poliester.

FRAME

Construction features load-bearing frames in solid fir wood of various thicknesses. All covered with 200g resin bonded to 100% polyester jersey.

STRUCTURE

Réalisée en bois de pin massif portant de différentes épaisseurs. Le tout recouvert avec un résiné de 200 gr. accouplé à une maille 100% polyester.

KORPUS

Aus massivem Tannenholz in verschiedenen Stärken. Alles mit Harz 200 gr bedeckt. gepaart mit 100% Polyester Pullover.

IMBOTTITURA

Cuscino seduta in espanso densità D40RC. Cuscino schiena in espanso indeformabile densità 35S. Entrambi i cuscini sono rivestiti con falda termolegata da 150g.

PADDING

Seat cushion in non-deformable foam density D40RC. Back cushion in density foam 35S. Both cushions are covered with a thermo-bonded layer of 150g felt.

REMBOURRAGE

Coussin d'assise en espansé indéformable D40RC. Coussin dossier en espansé 35S. Les deux oreillers sont rembourrés avec couche thermo-liée de 150 gr/mc.

POLSTERUNG

Sitzkissen aus Schaumstoff Dichte D40RC. Rückenkissen aus formbeständigem Schaumstoff Dichte 35S. Beide Kissen sind mit einer wärmegebundenen Schicht zu 150g versehen.

PIEDI

Basamento in metallo girevole con ritorno e finitura cromo.

FEET

Metal base, swivel with return and chrome finish.

PIEDS

Base en métal, pivotant avec retour et finition chrome.

FÜSSE

Drehbarer Metallfuß mit Rücklauf und verchromter Oberfläche.

Vibe

COMPLETAMENTE SFODERABILE / COMPLETELY REMOVABLE FABRIC COMPLÈTEMENT DÉHOUSSABLE / VOLLSTÄNDIG ENTFERNBAR

STRUTTURA

Realizzata con masselli in legno di abete massiccio di vari spessori, parti di tamponamento in fibra grezza e/o compensato di pino; fianchi in agglomerato di legno a bassa emissione di formaldeide (appartenente alla Classe E1). Poggiatesta dotato di cricchetto estraibile in acciaio con finitura cromo lucido. Possibilità di regolare l'inclinazione in 15 posizioni. Meccanismo sottoposto a severi test di resistenza.

FRAME

Made of solid fir in various thicknesses. Reinforcement parts in poplar wood fibre and/or plywood. Sides made of low formaldehyde emissions particleboard (Class E1). Headrest equipped with polished chrome finish steel pull-out ratchet. Inclination can be adjusted to 15 positions. Mechanism subject to strict resistance testing.

STRUCTURE

Réalisée en bois massif de pin portant de différentes épaisseurs. Fileurs de remplissage en fibre brute et/ou contreplaqué de peuplier. Côtés en aggloméré de bois à basse émission de formaldéhydes (appartenant à la Classe E1). Appui-tête doté de cliquet extractible en acier finition chrome brillant. Possibilité de régler l'inclinaison en 15 positions. Mécanisme soumis à de sévères tests de résistance.

KORPUS

Gefertigt aus Tannenmassivholz unterschiedlicher Stärke, gepolsterte Teile aus Rohfaser und Sperrholz aus Pappel; Seiten aus Spanplatte mit niedriger Formaldehydemission (eingestuft in die Klasse E1). Kopfstütze mit herausziehbarer Stahlratsche, glänzend verchromt. 15 Neigungspositionen einstellbar. Die Mechanik wurde schweren Beständigkeitsprüfungen unterzogen.

IMBOTTITURA

Cuscino seduta in espanso indeformabile con D30HS, il tutto rivestito in falda termolegata 300 gr. Cuscino poggiatesta in espanso D16S indeformabile, rivestito in falda termolegata 300 gr. Poggiatesta con meccanismo, in espanso indeformabile in D18S, il tutto rivestito in resinato di poliesteri 200 gr. accoppiato a vellutino 100% poliesteri.

PADDING

Seat cushion padding made of D30HS non-deformable foam, completely covered with 300 g thermo-bonded felt. Lumbar cushions made of D16S non-deformable foam covered with 300 g thermobonded felt. Headrest complete with mechanism made of D18S nondeformable foam, completely upholstered in 200 g polyester resin thermo-bonded to 100% polyester velveteen.

REBOURRAGE

Coussin assise en expansé indéformable de polyuréthane D30HS, le tout revêtu en couche thermo-liée 300gr. Coussin appui-reins en expansé indéformable de polyuréthane D16S, revêtu en couche thermo-liée 300gr. Appui-tête avec mécanisme, en expansé indéformable de polyuréthane D18S, le tout revêtu en résiné de polyester 200gr. couplé à chaud en velours 100% polyester.

POLSTERUNG

Sitzkissen aus unverformbarem Schaumstoff mit D30HAS, alles mit 300 g thermoverbundenem Vlies bezogen. Nierenstützkissen aus unverformbarem Schaumstoff D16S, bezogen mit 300 g themoverbundenem Vlies. Kopfstütze mit Mechanik, aus unverformbarem Schaumstoff D18S, beschichtet mit 200 g Polyesterharz in Kombination mit 100% Polyestersamt.

MOLLEGGIO

Il molleggio è realizzato in nastri da 80 mm tesi meccanicamente, composti da fili di nylon avvolto a spirale.

SPRINGING

Made of 80 mm wide mechanically tensioned webbing composed of nylon strands wound into a spiral.

SUSPENSION

Réalisée avec des bandes élastiques de 80 mm tendues mécaniquement, composées par des fils de gomme recouverts par du fil de nylon enroulé à spirale.

FEDERUNG

Hergestellt aus mechanisch gedehnten 80-mm-Elastikbändern, bestehend aus spiralförmig gewickelten Nylonfäden.

PIEDI

In alluminio pressofuso lucidato meccanicamente con finitura acciaio satinato - bronzo H 140 mm.

FEET

Made of die-cast aluminium polished mechanically with a satinized steel - bronze finish H 140 mm.

PIEDS

Pieds en aluminium moulés sous pression, mécaniquement, brillants avec finition en acier satiné - bronze H. 140 mm.

FÜSSE

Aus druckgegossenem Aluminium mechanisch mit satiniertem Stahlfinish Bronze lackiert H 140 mm.

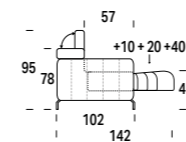

Art. 01

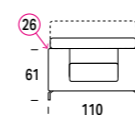

Art. 02

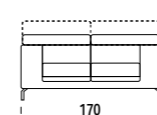

Art. 20

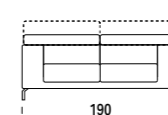

Art. 03

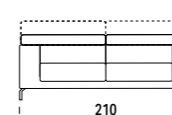

Art. 07

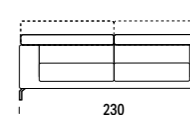

Art. SX MS
Art. DX MD

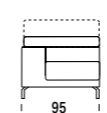

Art. SX LS
Art. DX LD

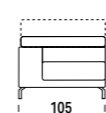

Art. SX 2S
Art. DX 2D

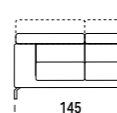

Art. SX GS
Art. DX GD

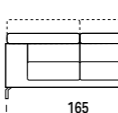

Art. SX 3S
Art. DX 3D

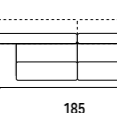

Art. SX 7S
Art. DX 7D

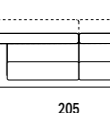

Art. SX CM
Art. DX MC

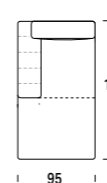

Art. SX CL
Art. DX LC

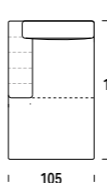

Art. SX QP
Art. DX PQ

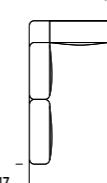

Art. AQ

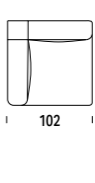

Art. 91



Art. 92

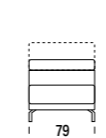

Art. 14

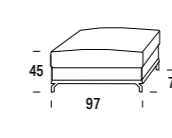

Art. 15

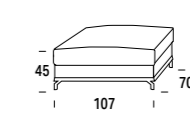

BRONZO

BRONZE
BRONZE
BRONZIERT



SATINATO

SATIN
SATINÉ
SATINIERT



ESEMPI COMPOSITIVI / COMPOSITION EXAMPLES / EXEMPLES DE COMPOSITION / KOMPOSITORISCHE BEISPIELE

Special 1

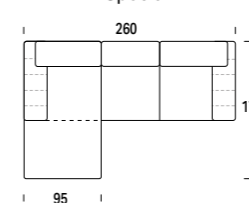

Special 2

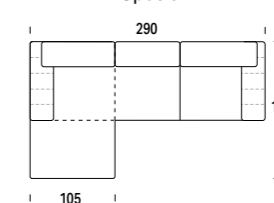

Isabel / Daisy

COMPLETAMENTE SFODERABILE / COMPLETELY REMOVABLE FABRIC COMPLÈTEMENT DÉHOUSSABLE / VOLLSTÄNDIG ENTFERNBAR

IMBOTTITURA

Le imbottiture dei cuscini sono in fodera pelle d'uovo poliestere-cotone, riempito del 70% di piume d'oca sterilizzate e del 30% di fiocco di poliestere 100% "verGINE".

PADDING

The cushion padding is made of polyester-cotton fine muslin lining, filled with 70% sterilised goose feathers and 30% "virgin" 100% polyester staple fibre.

REBOURRAGE

Les rembourrages des coussins sont en peau d'œuf polyester-coton, rempli à 70 % de plumes d'oie stérilisées et à 30 % de flocon de polyester 100 % « vierge ».

POLSTERUNG

Polsterung der Kissen mit Musselin-Bezug, gefüllt mit 70 % sterilisierten Gänsefedern und 30 % 100 % reiner Polyester-Stapelfaser.



Maury / Clara / Conny / Ben / Charlie / Mya / Carol / Bryan / Candy

COMPLETAMENTE SFODERABILE / COMPLETELY REMOVABLE FABRIC COMPLÈTEMENT DÉHOUSSABLE / VOLLSTÄNDIG ENTFERNBAR

IMBOTTITURA

Cuscini in fiocco vergine di poliestere al 100% ricoperti in tessuto non tessuto di poliestere.

PADDING

Cushions made of 100% virgin polyester staple fibre covered in non-woven polyester fabric.

REBOURRAGE

Coussins en flocon de polyester 100 % vierge recouverts de tissu non tissé en polyester.

POLSTERUNG

Kissen aus 100 % reinem Polyester-Stapelfasergewebe, bezogen mit Polyestervlies.



Clyde

COMPLETAMENTE SFODERABILE / COMPLETELY REMOVABLE FABRIC COMPLÈTEMENT DÉHOUSSABLE / VOLLSTÄNDIG ENTFERNBAR

IMBOTTITURA

Espanso in densità D18 SS ricoperto in resinato da 200gr.

PADDING

Foam with D18 SS density covered in 200g polyester resin.

REBOURRAGE

Mousse en densité D18 SS recouverte de résine de polyester de 200 g.

POLSTERUNG

Schaumstoff mit Dichte D18 SS, bezogen mit 200 g Polyesterharz.



Ritual

COMPLETAMENTE SFODERABILE / COMPLETELY REMOVABLE FABRIC COMPLÈTEMENT DÉHOUSSABLE / VOLLSTÄNDIG ENTFERNBAR

STRUTTURA

Realizzata in agglomerato di legno di spessore 18mm con struttura perimetrale in ferro. Cricchetti regolabili in 14 posizioni.

FRAME

Made of 18mm thick chipboard with iron perimeter structure. Ratchets adjustable to 14 positions.

STRUCTURE

Réalisé en aggloméré de bois de 18 mm d'épaisseur avec structure périmétrale en fer. Cliquets réglables en 14 positions.

KORPUS

Hergestellt aus 18 mm dicken Spanplatten mit einer Eisenstruktur am Rand. Verstellbare Ratschen in 14 Positionen.

IMBOTTITURA

Lastra in espanso indeformabile in densità D18 SS. Il tutto è rivestito con resinato da 200gr e accoppiato a maglia da 8mm entrambi termoaccoppiati a vellutino 100% poliestere. Cuscino ricoperto in pelle d'uovo. Cotone poliestere riempite al 70% piuma d'oca sterilizzata e 30% fiocco vergine di poliestere al 100%.

PADDING

Non-deformable foam sheet with D18 SS density. The entire assembly is covered with 200g resin and laminated with 8 mm jersey, both heat-coupled with 100% polyester velveteen. Cushion covered in fine muslin. Polyester cotton filled with 70% sterilised goose down and 30% virgin 100% polyester staple fibre.

REBOURRAGE

Plaque en mousse indéformable en densité D18 SS. Le tout est recouvert de résine de 200 g et couplé à une maille de 8 mm, tous deux thermocouplés à du velours 100 % polyester. Oreiller recouvert de peau d'œuf. Coton polyester rempli de 70 % de duvet d'oie stérilisé et de 30 % de fibres discontinues de polyester 100 % vierge.

POLSTERUNG

Nicht verformbare Schaumstoffplatte mit einer Dichte von D18 SS. Das Ganze ist mit 200 g Harz überzogen und mit 8 mm starkem Jersey laminiert, beides mit 100 % Polyester-Samtstoff wärmegekoppelt. Kissen mit Musselin-Polsterung. Polyester-Baumwolle, gefüllt mit 70% sterilisierten Gänsedaunen und 30% 100% Polyesterflock.

STRUTTURA

Schienale realizzato con nastri elastici composti da fili di gomma ricoperti da filo di nylon avvolto a spirale da 50 mm, tesi meccanicamente.

SPRINGING

Backrest made of elastic straps consisting of rubber threads covered with 50 mm spiral-wound nylon thread, mechanically stretched.

SUSPENSION

Dossier réalisé avec bandes élastiques composées de fils de caoutchouc recouverts de fil de nylon enroulé en spirale de 50 mm, tendus mécaniquement.

FEDERUNG

Rückenlehne aus elastischen Gurten, bestehend aus Gummifäden, die mit einem 50 mm dicken, spiralförmig gewickelten Nylonfaden ummantelt sind, der mechanisch gespannt wird.



Art. 80 – 75 x 50

Art. 81 – 85 x 50



Daisy

COMPLETAMENTE SFODERABILE / COMPLETELY REMOVABLE FABRIC COMPLÈTEMENT DÉHOUSSABLE / VOLLSTÄNDIG ENTFERNBAR



Rifinitura: standard
Finish: standard
Finition: standard
Verarbeitung: Standard

Art. 51 – 55 x 55

Bryan



Rifinitura: pizzicato 1,5
Finish: pinched 1.5
Finition: pincé 1,5
Verarbeitung: in Pinched-Optik 1,5

Art. 51 – 50 x 50
Art. 52 – 60 x 60
Art. 53 – 50 x 35

Maury

COMPLETAMENTE SFODERABILE / COMPLETELY REMOVABLE FABRIC COMPLÈTEMENT DÉHOUSSABLE / VOLLSTÄNDIG ENTFERNBAR



Rifinitura: punto croce
Finish: cross stitch
Finition: point de croix
Verarbeitung: Kreuzstich

Bordo in tinta o bordo a contrasto
Piping in same or contrasting colour
Bord en teinte ou en contraste
Kante Ton-in-Ton oder farblich abgesetzt

Art. 50 – 40 x 40
Art. 51 – 50 x 50

quadro – square
carré – quadratische



Art. 53 – 50 x 35

rettangolare – rectangular
rectangulaire – rechteckige



Disponibili cuciture di finitura in tinta e/o in contrasto
Available with top stitching in the same and/or contrasting colour
Disponibilité des coutures de finition en teinte et/ou en contraste
Kante Ton-in-Ton oder farblich abgesetzt

2000		575	
419		578	
42		326	
415		379	
4000		1185	
113		565	
118		262	
123		864	
504		1097	
1314		1091	
600		816	
1411		821	
869			

Candy



Rifinitura: bordo 2 cm
Finish: 2 cm border
Finition: bordure de 2 cm
Verarbeitung: 2 cm Rand

Art. 51 – 50 x 50
Art. 52 – 60 x 60
Art. 53 – 50 x 35

Isabel



Rifinitura: ribattuta
Finish: felled seam
Finition: couture rabattue
Verarbeitung: Kappnaht

Art. RM – 55 x 30
Art. RL – 65 x 30
Art. RI – 75 x 30
Art. RX – 85 x 30



Clara

COMPLETAMENTE SFODERABILE / COMPLETELY REMOVABLE FABRIC COMPLÈTEMENT DÉHOUSSABLE / VOLLSTÄNDIG ENTFERNBAR



Rifinitura: pizzicato 0,5
Finish: pinched 0.5
Finition: pincé 0,5
Verarbeitung: in Pinched-Optik 0,5

Conny



Rifinitura: bordo
Finish: piped
Finition: bordé
Verarbeitung: Kante

Bordo in tinta o bordo a contrasto
Piping in same or contrasting colour
Bord en teinte ou en contraste
Kante Ton-in-Ton oder farblich abgesetzt

Ben

COMPLETAMENTE SFODERABILE / COMPLETELY REMOVABLE FABRIC COMPLÈTEMENT DÉHOUSSABLE / VOLLSTÄNDIG ENTFERNBAR



Rifinitura: bordo con bottone
Finish: piping with button
Finition: bord avec bouton
Verarbeitung: Kante mit Knopf

Bordo in tinta o bordo a contrasto
Piping in same or contrasting colour
Bord en teinte ou en contraste
Kante Ton-in-Ton oder farblich abgesetzt

Charlie



Rifinitura: standard
Finish: standard
Finition: standard
Verarbeitung: Standard

Art. 50 – 40 x 40
Art. 51 – 50 x 50

quadro – square
carré – quadratische



Art. 50 – 40 x 40
Art. 51 – 50 x 50

quadro – square
carré – quadratische



Art. 50 – 40 x 40
Art. 51 – 50 x 50

quadro – square
carré – quadratische



Art. 50 – 40 x 40
Art. 51 – 50 x 50

quadro – square
carré – quadratische



Art. 53 – 50 x 35

rettangolare – rectangular
rectangulaire – rechteckige



Art. 53 – 50 x 35

rettangolare – rectangular
rectangulaire – rechteckige



Art. 53 – 50 x 35

rettangolare – rectangular
rectangulaire – rechteckige



Art. 53 – 50 x 35

rettangolare – rectangular
rectangulaire – rechteckige



Art. 43 – ø50

tondo – round
rond – runden



Art. 43 – ø50

tondo – round
rond – runden

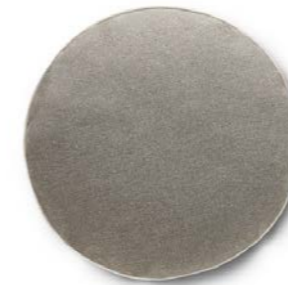

Art. 43 – ø50

tondo – round
rond – runden



Art. 43 – ø50

tondo – round
rond – runden



Mya

COMPLETAMENTE SFODERABILE / COMPLETELY REMOVABLE FABRIC COMPLÈTEMENT DÉHOUSSABLE / VOLLSTÄNDIG ENTFERNBAR



Rifinitura: con cucitura 4 cm
Finish: with 4cm stitching
Finition: coutures de 4 cm
Verarbeitung: Kissen mit 4cm Nähten

Art. 51 – 50 x 50

quadro – square
carré – quadratische



Carol



Rifinitura: ribattuta
Finish: felled seam
Finition: couture rabattue
Verarbeitung: Kappnaht

Art. 50 – 40 x 40
Art. 51 – 50 x 50

quadro – square
carré – quadratische



Clyde

COMPLETAMENTE SFODERABILE / COMPLETELY REMOVABLE FABRIC COMPLÈTEMENT DÉHOUSSABLE / VOLLSTÄNDIG ENTFERNBAR



Art. 71A – ø18 x 60

cilindro – cylinder
cylindre – zylinder

Rifinitura: liscio
Finish: smooth/plain
Finition: lisse
Verarbeitung: glatt

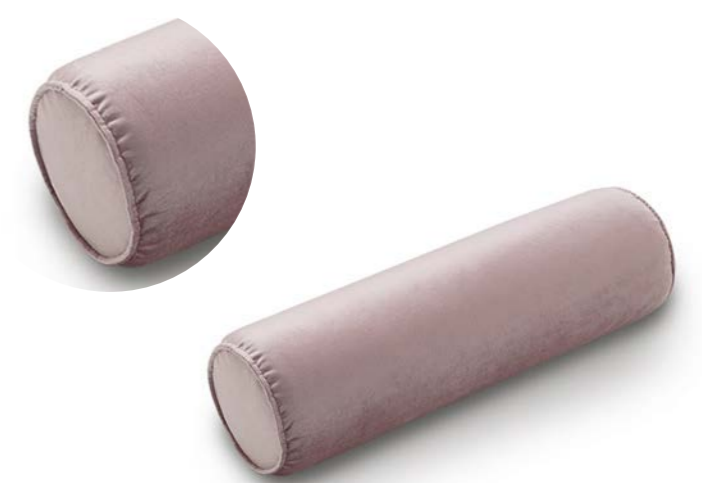

Art. 71B – ø18 x 60

cilindro – cylinder
cylindre – zylinder

Rifinitura: pizzicato 0,5
Finish: pinched 0.5
Finition: pincé 0,5
Verarbeitung: in Pinched-Optik 0,5



Art. 71C – ø18 x 60

cilindro – cylinder
cylindre – zylinder

Rifinitura: bordo
Finish: piped
Finition: bordé
Verarbeitung: Kante

Billy - Cubik - Pam - Pika - Ted

COMPLETAMENTE SFODERABILE / COMPLETELY REMOVABLE FABRIC COMPLÈTEMENT DÉHOUSSABLE / VOLLSTÄNDIG ENTFERNBAR

STRUTTURA

Realizzata in agglomerato di legno di spessore 10mm. Il tutto trattato al naturale in classe E1, pertanto a bassa emissione di formaldeide. Polistirolo espanso in densità 10N.

FRAME

Made of 10mm thick particleboard. All treated naturally in class E1, therefore with low formaldehyde emissions. 10N density polystyrene foam.

STRUCTURE

Réalisée en bois aggloméré épaisseur 10 mm. Le tout traité au naturel en classe E1, pour autant à basse émission de formaldéhyde. Polystyrène expansé en densité 10N.

KORPUS

Aus Spanholz hergestellt, mit Stärke 10 mm. Alles wurde natürlich behandelt und entspricht Klasse E, d.h. mit geringer Formaldehydabgabe. Polystyrol aufgeschäumt mit einer Dichte von 10N.

IMBOTTITURA

Seduta: lastra in poliuretano espanso flessibile e indeformabile in densità D30HS fresato tondo sul perimetro. Parti di tamponamento perimetrale: lastre sagomate di poliuretano indeformabile in D16S. Falda termolegata da 300 gr/mq in ovatta di poliestere 100 %. Il tutto rivestito con poliuretano accoppiato a maglia resinato da 200g 100 % poliestere.

PADDING

Seat: flexible non-deformable D30HS density polyurethane foam sheet with round milled perimeter. Perimeter reinforcement parts: shaped D16S non-deformable polyurethane sheets. Thermobonded layer 100 % polyester wadding 300 g/sq. m. All covered with polyurethane bonded to 200 g 100% polyester resin jersey.

REMOURRAGE

Assise : plaque en polyuréthane expansé flexible et indéformable densité D30HS fraisé arrondi sur le périmètre. Parties de remplissage périmétrale : plaques modelées en polyuréthane indéformable en D16S. Bord thermo-lié de 300gr./m2 en 100% ouate de polyester. Le tout revêtu par du polyuréthane accouplé à 200 gr. de maille résinée 100% polyester.

POLSTERUNG

Sitzfläche: formbeständiger, elastischer Polyurethanschäumkern mit einer Dichte von D30HS, rundum gefräst. Umlaufende Polsterung aus formstabilem Polyurethan in D16S. Wärmegebundene Schicht zu 300g/qm aus 100% Polyesterwatte. Das Ganze ist mit Polyurethan verkleidet, der auf geharzte Watte zu 200g aus 100% Polyester aufkaschiert ist.

Secret - Secret Big

COMPLETAMENTE SFODERABILE / COMPLETELY REMOVABLE FABRIC COMPLÈTEMENT DÉHOUSSABLE / VOLLSTÄNDIG ENTFERNBAR

STRUTTURA

Realizzata in agglomerato di legno di spessore 18mm. Rifinitura interna in laminato nero opaco. Il tutto in classe E1, pertanto a bassa emissione di formaldeide.

FRAME

Made of 18mm-thick chipboard. Interior finish in matt black laminate. All in class E1, thus with low formaldehyde emission.

STRUCTURE

Fabriqué en bois aggloméré de 18 mm d'épaisseur. Finition intérieure en stratifié noir mat. Le tout en classe E1, donc à faible émission de formaldéhyde.

KORPUS

Hergestellt aus 18 mm dicken Spanplatten. Innenverkleidung aus mattschwarzem Laminat. Alles in Klasse E1, also mit geringer Formaldehydabgabe

IMBOTTITURA

Lastra in espanso indeformabile in densità 30 rivestito con resinato da 200gr. Il tutto è rivestito con resinato da 200gr termocoppiato a vellutino 100% poliestere.

PADDING

Non-deformable foam sheet with density 30 covered with 200g resin. The entire structure is coated with 200g resin thermobonded with 100% polyester velveteen.

REMOURRAGE

Plaque de mousse indéformable de densité 30 recouverte de 200 g de résine. Le tout est recouvert de résine de 200 g thermocouplée à du velours 100 % polyester.

POLSTERUNG

Formstabile Schaumstoffplatte mit einer Dichte von 30, bedeckt mit 200 g Harz. Das Ganze ist mit 200 g Harz überzogen und mit 100% Polyester-Samt laminiert.

PIEDI

Piedini in ABS nero H60mm. Optional ruote girevoli H60mm.

FEET

Black ABS feet H60mm. Optional swivel castors H60mm.

PIEDS

Pieds en ABS noir H60mm. En option roues pivotantes H60mm.

FÜSSE

Schwarze ABS-Füße H60mm. Optionale Lenkrollen H60mm.

PIEDI

Piedini in ABS nero da 20mm.

FEET

20mm black ABS feet.

PIEDS

Pieds en ABS de 20 mm.

FÜSSE

Füße in schwarzem ABS zu 20 mm.



Zeppelin

COMPLETAMENTE SFODERABILE / COMPLETELY REMOVABLE FABRIC COMPLÈTEMENT DÉHOUSSABLE / VOLLSTÄNDIG ENTFERNBAR

Tutti i comandi a sfioramento touch.

Ascoltare la musica preferita, web radio o podcast, predisporre la radiosveglia, ricaricare in qualunque ambiente della casa. Nella dock station l'aggancio è predisposto per l'iPhone e l'iPod o qualunque altro dispositivo che può essere collegato tramite Bluetooth, porta usb o uscita aux.

All touch controls. Enjoy your favourite music, web radio or podcast, set the radio alarm, recharge in any room of the house. The docking station is designed to take iPhones iPods, or any other device that can be connected by Bluetooth, USB port, and aux output.

Toutes les commandes sont tactiles. Écouter votre musique préférée, la radio sur internet ou des podcasts, régler votre réveil, recharger vos dispositifs mobiles n'importe où chez vous. La centrale est prédisposée pour accueillir un iPhone et un iPod, ou tout autre dispositif pouvant être connecté via Bluetooth, port USB et une sortie AUX.

Touch-Bedienelemente. Hören Sie Ihre Lieblingsmusik, Webradio oder Podcasts, stellen Sie den Radiowecker ein, laden Sie in jedem Raum des Hauses. In der Dockingstation ist die Verbindung für iPhone und iPod oder jedes andere Gerät vorbereitet, das über Bluetooth, USB-Anschluss oder Aux-Ausgang angeschlossen werden kann.

STRUTTURA

Telaio in legno di abete da 18/25 mm, parti di tamponamento in fi bra di legno naturale e in compensato. Il tutto in classe E1, pertanto a bassa emissione di formaldeide.

FRAME

18/25 mm thick fir wood frame with natural wood fi bre and plywood reinforcement parts. All in Class E1, thus with low formaldehyde emissions.

STRUCTURE

Structure en bois de sapin de 18/25 mm, éléments de remplissage en fibre de bois naturel et contreplaqué. Le tout classe E1, soit à faible émission de formaldéhydes.

KORPUS

18/25 mm Tannenholzrahmen, Füllungsteile aus Naturholzfäsern und Sperrholz. Alles in Klasse E1, also mit geringer Formaldehydabgabe.

IMBOTTITURA

Lastra in espanso indeformabile in densità 30 rivestito con resinato da 200gr. Il tutto è rivestito con resinato da 200gr termocoppiato a vellutino 100% poliestere.

PADDING

Non-deformable foam sheet with density 30 covered with 200g resin. The entire structure is coated with 200g resin thermobonded with 100% polyester velveteen.

REMOURRAGE

Plaque de mousse indéformable de densité 30 recouverte de 200 g de résine. Le tout est recouvert de résine de 200 g thermocouplée à du velours 100 % polyester.

POLSTERUNG

Formstabile Schaumstoffplatte mit einer Dichte von 30, bedeckt mit 200 g Harz. Das Ganze ist mit 200 g Harz überzogen und mit 100% Polyester-Samt laminiert.

PIEDI

Piedini in ABS nero da 20mm.

FEET

Black ABS plastic feet H 20 mm, not visible.

PIEDS

Pieds en ABS noir H. 20 mm, non visibles.

FÜSSE

Füße in schwarzem ABS H. 20mm nicht sichtbar.

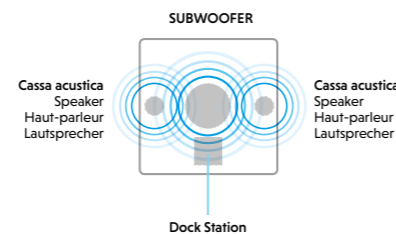

Ted

Art. 21 – ø55 h 40 | Art. 22 – ø65 h 40 | Art. 23 – ø95 h 40

Rifinitura: pizzicato 0,5 / Finish: pinched / 0.5 Finition: pincé 0,5 / Verarbeitung: in Pinched-Optik 0,5

Art. 21
Tondo - ø 55 h 40
Round - ø 55 h 40
Rond - ø 55 h 40
Runden - ø 55 h 40

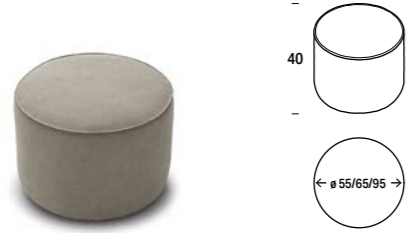

Art. 23
Tondo - ø 95 h 40
Round - ø 95 h 40
Rond - ø 95 h 40
Runden - ø 95 h 40



Billy

Art. 21 – ø55 h 40 | Art. 22 – ø65 h 40 | Art. 23 – ø95 h 40

Rifinitura: bordato / Finish: piped / Finition: bordé / Verarbeitung: eingefasst

Art. 21
Tondo - ø 55 h 40
Round - ø 55 h 40
Rond - ø 55 h 40
Runden - ø 55 h 40

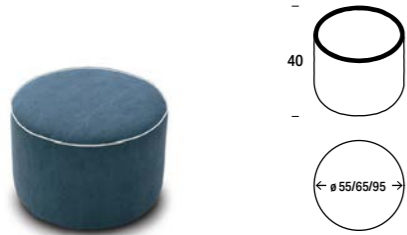

Art. 23
Tondo - ø 95 h 40
Round - ø 95 h 40
Rond - ø 95 h 40
Runden - ø 95 h 40



Pika

Art. 26 – 70 x 100 h 40 | Art. 24 – 60 x 60 h 40 | Art. 25 – 100 x 100 h 40

Rifinitura: pizzicato 0,5 / Finish: pinched / 0.5 Finition: pincé 0,5 / Verarbeitung: in Pinched-Optik 0,5

Art. 26 - 70 x 100 h 40
rettangolare
rectangular
rectangulaire
rechteckige

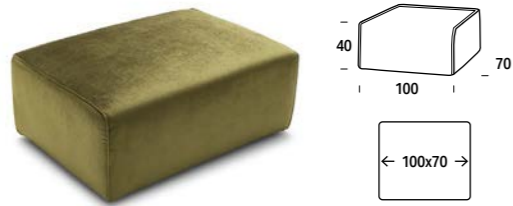

Art. 24 - 60 x 60 h 40
Art. 25 - 100 x 100 h 40
quadro
square
carré
quadratische



Pam

Art. 26 – 70 x 100 h 40 | Art. 24 – 60 x 60 h 40 | Art. 25 – 100 x 100 h 40

Rifinitura: bordato / Finish: piped / Finition: bordé / Verarbeitung: eingefasst

Art. 26 - 70 x 100 h 40
rettangolare
rectangular
rectangulaire
rechteckige

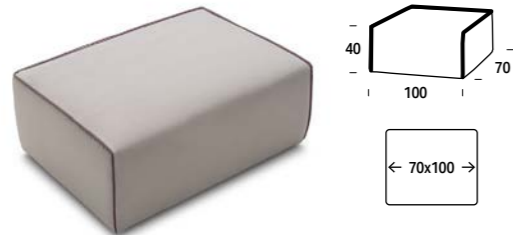

Art. 24 - 60 x 60 h 40
Art. 25 - 100 x 100 h 40
quadro
square
carré
quadratische



Secret

Art. 15 – 52 x 52 h 46

Rifinitura: standard / Finish: standard / Finition: standard / Verarbeitung: Standard

Art. 15 - 52 x 52 h 46
Quadro - 52 x 52 h 46
Square - 52 x 52 h 46
Carré - 52 x 52 h 46
Quadratische - 52 x 52 h 46



Optional - con ruote girevoli
Optional - with rotating castors
Optionnel - avec roues tournantes
Optional - mit Lenkrollen



Secret big

Art. 16 – 72 x 52 h 46

Rifinitura: standard / Finish: standard / Finition: standard / Verarbeitung: Standard

Art. 16 – 72 x 52 h 46
Rettangolare - 72 x 52 h 46
Rectangular - 72 x 52 h 46
Rectangulaire - 72 x 52 h 46
Rechteckige - 72 x 52 h 46



Optional - con ruote girevoli
Optional - with rotating castors
Optionnel - avec roues tournantes
Optional - mit Lenkrollen

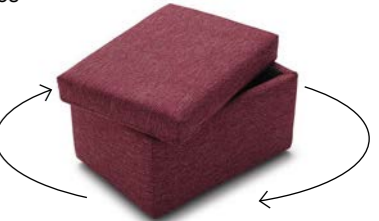

Cubik

Art. 18 – 43 x 43 h 43

Rifinitura: pizzicato 0,5 / Finish: pinched / 0.5 Finition: pincé 0,5 / Verarbeitung: in Pinched-Optik 0,5

Art. 18 – 43 x 43 h 43
Cubo - 43 x 43 h 43
Cube - 43 x 43 h 43
Cube - 43 x 43 h 43
Würfel - 43 x 43 h 43



Zeppelin

Art. 10A – 50 x 50 h 44 | Art. 10B – 50 x 50 h 44

Piano quadrato 50 x 50 cm / Square top 50 x 50 cm / Plan carré 50 x 50 cm / Quadratische Platte 50 x 50

Rifinitura: bordato
Finish: piped
Finition: bordé
Verarbeitung: eingefasst

Art. 10A – 50 x 50 h 44

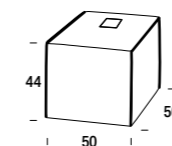

Rifinitura: pizzicato 0,5
Finish: pinched 0.5
Finition: pincé 0,5
Verarbeitung: in Pinched-Optik 0,5

Art. 10B – 50 x 50 h 44

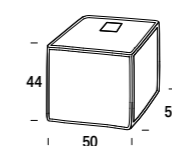

I dispositivi collegati vengono anche ricaricati.
Connected devices are also charged.
Les appareils connectés sont également rechargés.
Angeglichene Geräte werden ebenfalls aufgeladen.

