

Start



**CLEVER**



ITA Dal 1993 Clever progetta e realizza soluzioni per la zona notte dei bambini e dei giovani. Una sfida continua e appassionante, alla quale l'azienda dedica tutta la sua ricerca formale e tecnologica, analizzando gli spazi domestici e i nuovi stili di vita. Da questa esperienza nasce Start: un sistema componibile e trasformabile di letti, guardaroba, cabine armadio, librerie, scrivanie, complementi e soluzioni salvaspazio che prendono forma dalla specializzazione di Clever in questo settore e da un processo produttivo di qualità totale. La vastissima scelta di finiture e colori, insieme alla possibilità di realizzazioni su misura, consente di personalizzare ogni soluzione, sintonizzandosi con ogni scenario d'interni e gusto personale. Tutto questo con la massima attenzione al benessere e alla sostenibilità, grazie all'utilizzo di materiali atossici, vernici con ioni d'argento antibatterici e pannelli ecologici che preservano il patrimonio forestale del pianeta: anche per questo, scegliere Start significa pensare al futuro delle nuove generazioni.

ENG Since 1993 Clever has been designing and manufacturing solutions for children's and young people's sleeping areas. A continuous and exciting challenge, to which the company dedicates all its formal and technological research, analysing domestic spaces and new lifestyles. Start is the result of this experience: a modular and transformable system of beds, wardrobes, walk-in wardrobes, bookcases, desks, complements and space-saving solutions that take shape from Clever's specialisation in this sector and from a total quality production process. The wide choice of finishes and colours, together with the possibility of custom-made products, allows to customize each solution, tuning it to any interior scenario and personal taste. All this with the utmost attention to wellbeing and sustainability, thanks to the use of non-toxic materials, antibacterial silver ion paints and ecological panels that preserve the planet's forest heritage: for this reason too, choosing Start means thinking about the future of new generations.



# INDEX

01	LETTI A TERRA	FLOOR-STANDING BEDS	P.007
02	PONTI	BRIDGES	P.157
03	SALVASPAZIO	SPACE-SAVING BEDS	P.277
04	DATI TECNICI	TECHNICAL DATA	P.321
05	COMPOSIZIONI	COMPOSITIONS	P.333

ITA Un habitat dove studiare, rilassarsi, invitare gli amici, navigare sul web e soprattutto nella fantasia... la camera degli adolescenti è lo spazio più polifunzionale e dinamico e della casa. Uno scenario che si trasforma in continuazione, con il crescere dell'esigenza di organizzare una miriade di oggetti, vestiti, libri e passioni. Un ambiente che dichiara a prima vista la propria indipendenza dalle altre stanze, ma al tempo stesso mantiene una continuità rispetto allo stile di vita e all'atmosfera della casa. Singolo o doppio, il letto a terra è insieme al guardaroba il protagonista di uno spazio ampio e accogliente, tutto da inventare e da abitare.

ENG A habitat where you can study, relax, invite friends over, surf the internet and above all fantasize ... the teenagers' room is the most multifunctional and dynamic space in the house. A scenario that is constantly changing as the need to organize a myriad of objects, clothes, books and passions grows. An environment that at first glance declares its independence from the other rooms, but at the same time maintains continuity with the lifestyle and atmosphere of the house. Single or double, the floor-standing bed is, together with the wardrobe, the protagonist of a large and welcoming space, all to be invented and lived in.



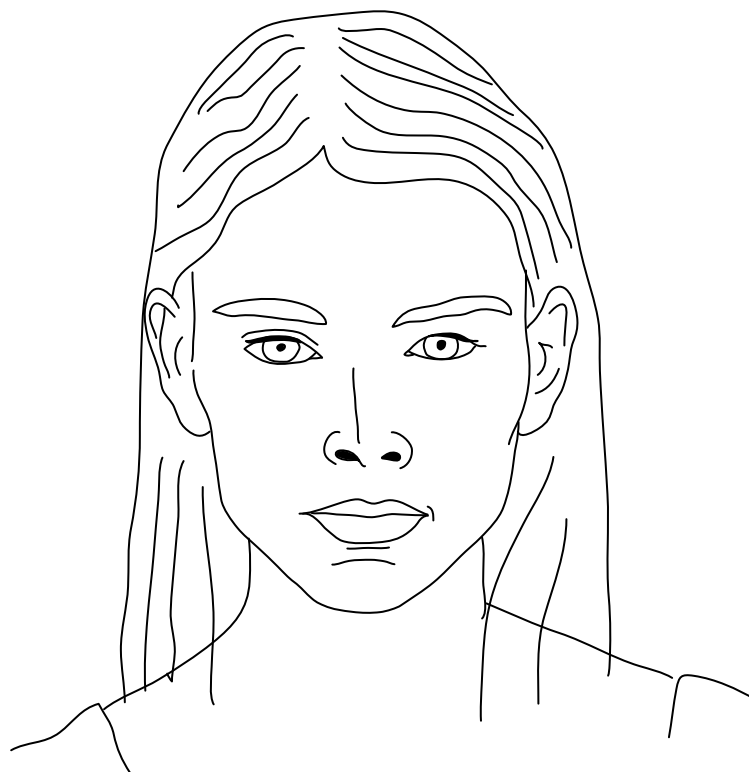

ITA Finalmente è arrivato il grande giorno: da ieri sono ufficialmente diventata maggiorenne. Ma rimango quella di sempre, con il carattere che ho sempre avuto da bambina: un po' timida, inguaribile romantica, molto persa dietro ai miei sogni ad occhi aperti. La mia passione è la danza classica e dopo una giornata di studio "matto e disperatissimo", come dice la cara vecchia prof di italiano, mi rifugio finalmente nella mia camera, faccio partire Tchaikovsky e provo qualche passo, immaginando di essere a teatro. Ma mi raccomando, non ditelo a nessuno!

ENG The big day has finally arrived: as of yesterday I have officially come of age. But I remain the same as ever, with the character I always had as a child: a bit shy, incurable romantic, very lost in my daydreams. My passion is ballet, and after a day of "crazy and desperate" study, as my dear old Italian teacher says, I finally take refuge in my room, play Tchaikovsky and try a few steps, imagining I'm at the theatre. But please, don't tell anyone!











Letto Hadley con giroletto 45° e testiera imbottita in tessuto Marmolada M008, tavolino Dora uso comodo./Hadley bed with 45° bed frame and upholstered headboard in Marmolada M008 fabric, Dora table used as night table.





Zona studio composta da sistemi pensili Sipario retroilluminati, piano scrittoio sp.50mm, sistema Boiserie orizzontale con mensole sp.12 e profondità 250mm./ Study area composed of Sipario wall units with backlight, desk in th.50mm, horizontal Boiserie system with shelves in th.12mm and 250mm in depth.

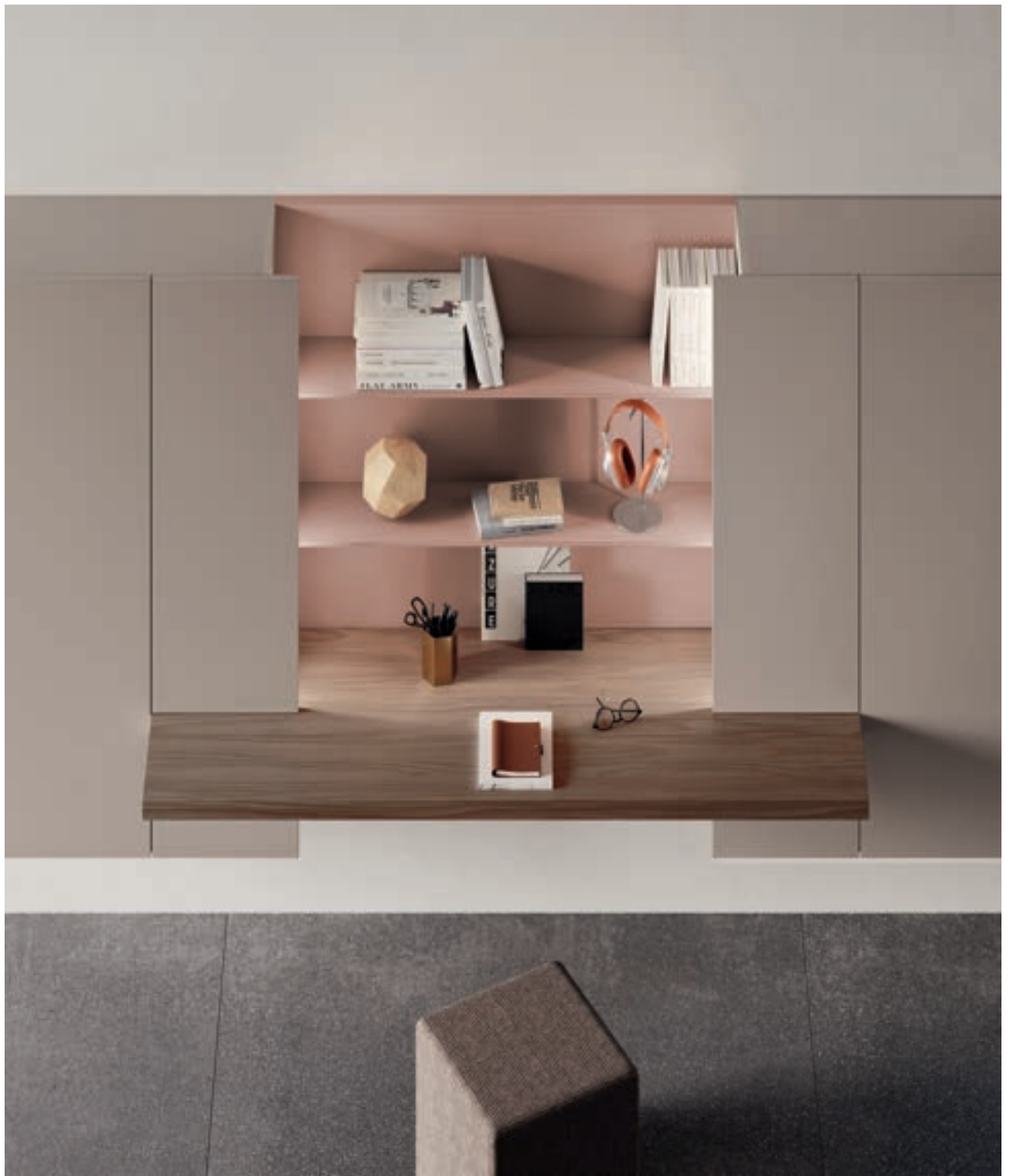









Armadio Box, armadio Sipario con ante battenti sporgenti e retro illuminate, affiancato a sistema Boiserie orizzontale con mensole. / Box wardrobe, Sipario wardrobe with protruding hinged doors with backlight, next to horizontal Boiserie with shelves.





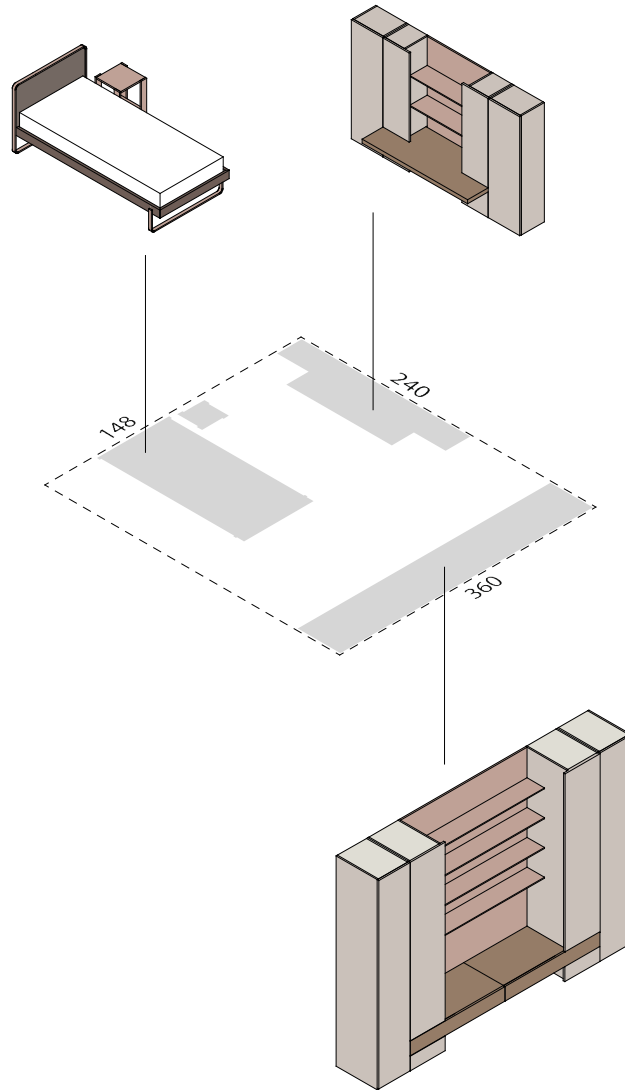

**Finiture/ Finishes:**

- A - Melaminico Noce/ Noce melamine
- B - Melaminico Tortora/ Tortora melamine
- C - Dekor Bronzo
- D - Melaminico Dalia/ Dalia melamine
- E - Tessuto Marmolada M008/ Marmolada M008 fabric



A



B



C



D

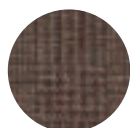

E

**Elementi/ Elements:**

- 1 - Letto Hadley/ Hadley bed
- 2 - Armadio Box/ Box wardrobe
- 3 - Armadio Sipario/ Sipario wardrobe
- 4 - Sistema Boiserie orizzontale/ Horizontal Boiserie System
- 5 - Tavolino Dora/ Dora coffee table



ITA Se fosse per me, domani partirei per un viaggio alla scoperta della natura più selvaggia. Islanda? Australia? Terra del Fuoco? Butterei quattro cose nello zaino, salirei su un aereo e via. Ma prima c'è la sessione di esami e quindi niente, mi ci devo mettere sotto. Del resto, ho sempre avuto la mania di queste cose. L'altro giorno è venuto a trovarmi Enrico e sapete cosa mi ha detto? Si vede che studi Biologia Marina. Da cosa, gli ho chiesto? Dai colori della tua stanza mi ha risposto, e ci siamo messi a ridere.

ENG If it were up to me, tomorrow I would go on a journey of discovery into the wilderness. Iceland? Australia? Tierra del Fuego? I'd throw a few things in my backpack, hop on a plane and go. But first there's the exam session, so nothing, I'll have to get on with it. Besides, I've always been obsessed with these things. The other day Enrico came to see me and do you know what he said? He said You must be studying Marine Biology. From what, I asked him? From the colours in your room, he replied, and we started laughing.

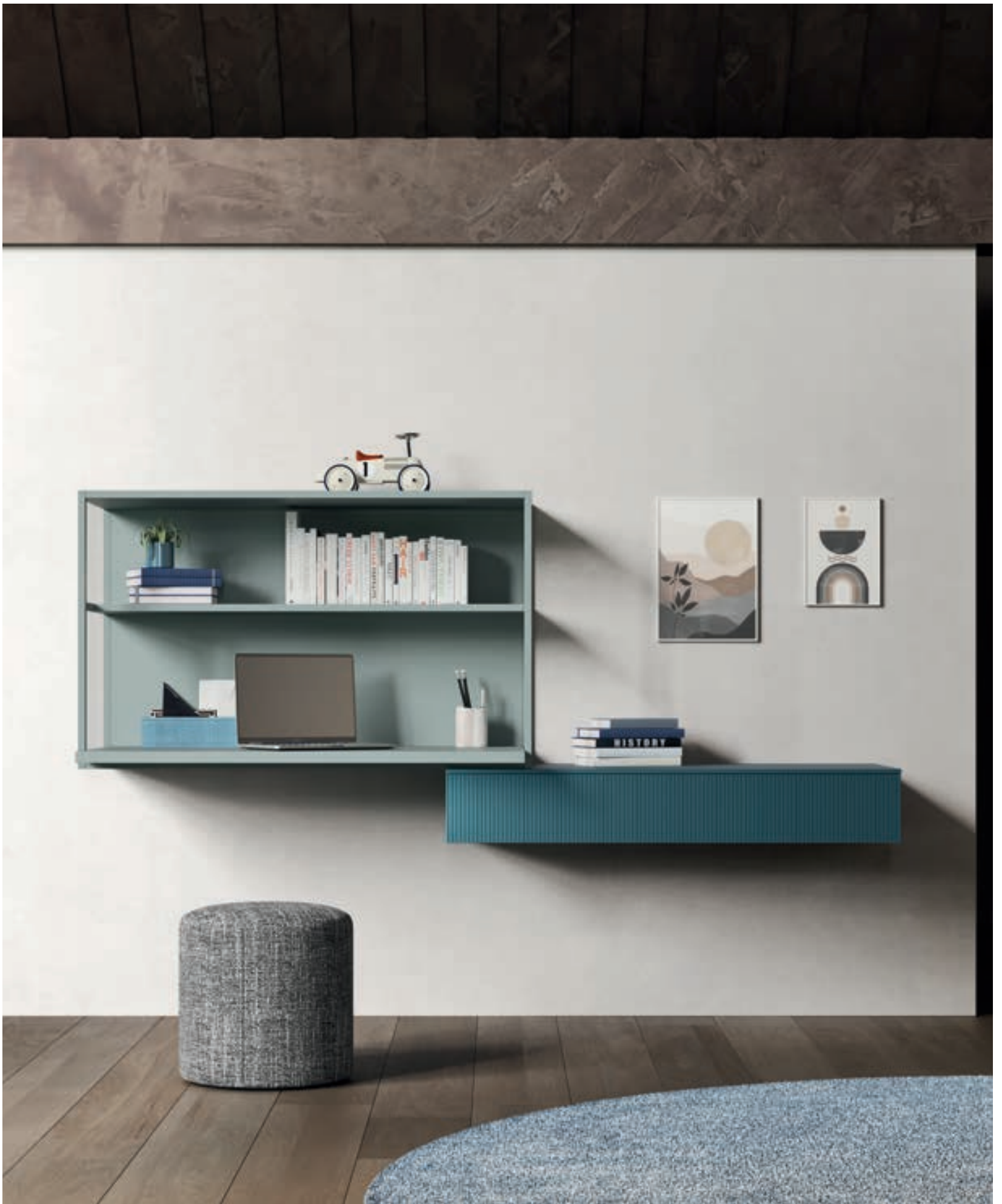





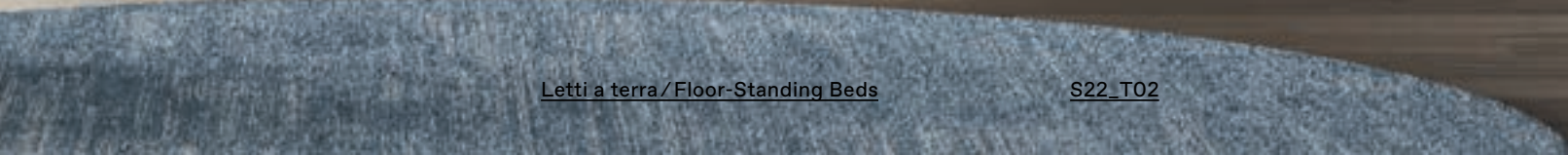
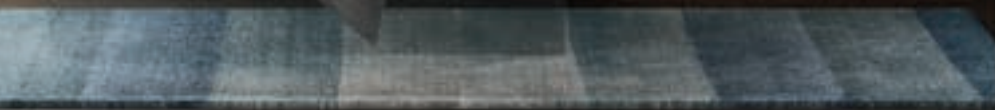



Testiera letto sospesa Kios con cuscino imbottito in tessuto Sarin S304, giroletto 45° con piedi in vetro./Suspended bed headboard with upholstered panel in Sarin S304 fabric, 45° bed frame and glass legs.





Scrivania sospesa Kios in appoggio a pensile con cassetto con frontale linea laccato.  
/Suspended desk Kios resting on a wall unit with drawer in lacquered Linea finish.

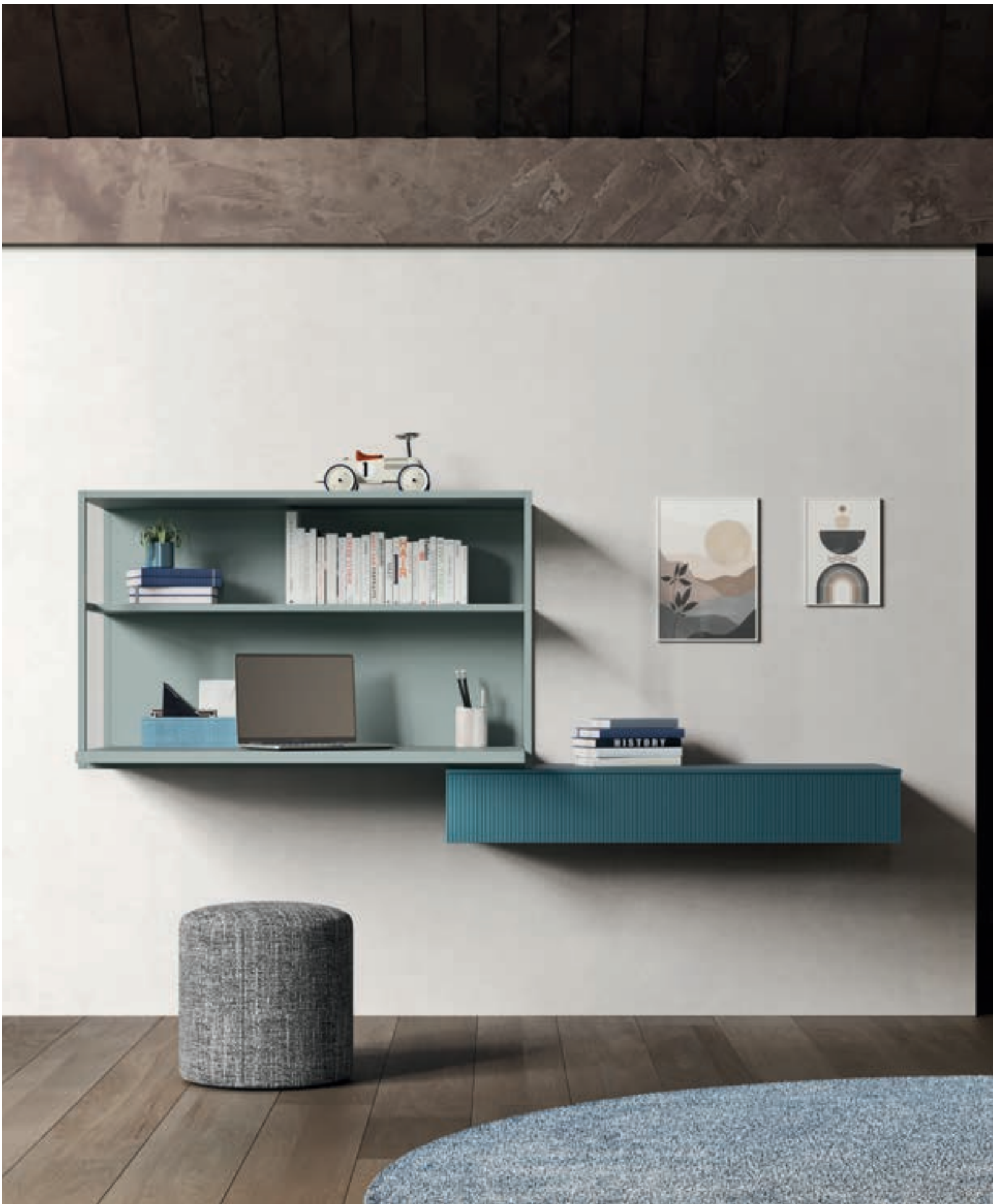







Armadio Box attrezzato internamente da divisori con ripiani, cassettera interna, cestello estraibile e tubo appendiabiti./ Box wardrobe equipped with shelves, drawer pack, movable basket and one hanger tube.







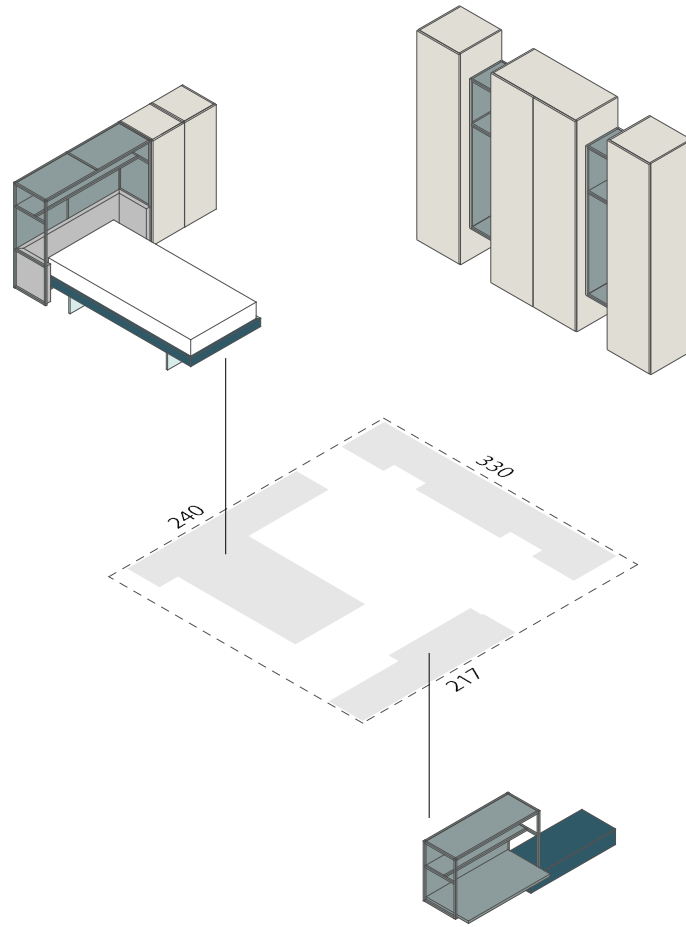

**Finiture / Finishes:**

- A - Melaminico Seta / Seta melamine
- B - Laccato Indaco / Indaco lacquered finish
- C - Laccato Avio / Avio lacquered finish
- D - Tessuto Sarin S304 / Sarin S304 fabric

**Elementi / Elements:**

- 1 - Testata Letto Kios / Kios bed headboard
- 2 - Scrivania Sospeso Kios / Suspended Kios desk
- 3 - Armadio Box / Box wardrobe
- 4 - Elementi Sospesi Kios / Suspended wall units Kios



A



B



C

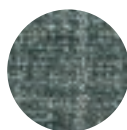

D

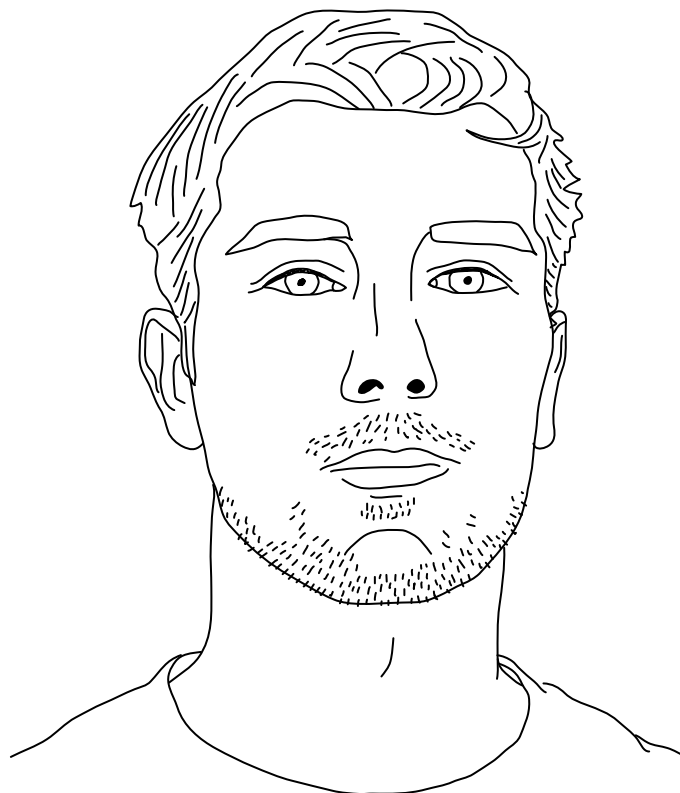

ITA È venerdì sera ed è arrivato il momento di iniziare un favoloso weekend. Prima di sentire gli amici, mi rilasso un po'. La settimana in studio è stata dura: ho appena iniziato e devo imparare tutto. Ma metterò a frutto il mio bel diplomino in Tecnico dell'Ambiente e Territorio: il lavoro mi piace, mi hanno accolto bene e sono tutti ok... certo che al primo colloquio ero emozionato, ma quando gli ho detto che ho la passione per il design, si sono convinti subito a prendermi.

ENG It's Friday night and it's time to start a fabulous weekend. Before hearing from friends, I relax a little. The week in the studio has been tough: I've just started and I have to learn everything. But I'm going to put my diploma in Environmental and Territorial Technician to good use: I like the job, I've been well received and everyone is OK... of course I was excited at the first interview, but when I told them I had a passion for design, they were immediately convinced to take me on.













Armadio Box sospeso con ante battenti e maniglia Ghost. Sistema cabina Kubo con ripiani e tubo appendiabiti./Suspended Box wardrobe with Ghost handle. Kubo element with shelves and one hanger tube.





Letto Sipario con testiera imbottita in tessuto Murano M035 e Demetra D005, giroletto 45° e piede in vetro. Tavolino Tondo uso comodo./Sipario bed with upholstered headboard in Murano M035 and Demetra D005 fabric, 45° bed frame with glass legs. Tondo coffee table used as night table.



Zona studio composta da scrittoio sospeso Kubo in appoggio a pensile con cassetto con frontale Linea laccato e libreria Kubo. / Study area composed of suspended desk Kubo resting on wall units with drawer in lacquered Linea finish and Kubo library.





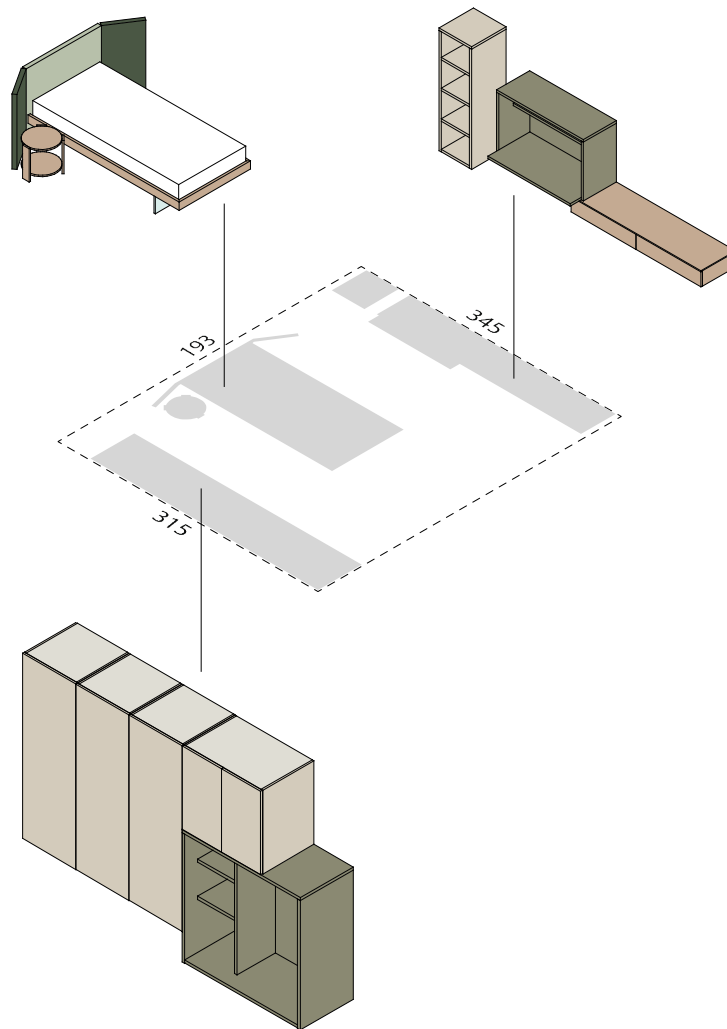

**Finiture / Finishes:**

- A - Melaminico Beige / Beige melamine
- B - Laccato Caramello / Caramello lacquered finish
- C - Laccato Oliva / Oliva lacquered finish
- D - Tessuto Murano M035 / Murano M035 fabric
- E - Tessuto Demetra D005 / Demetra D005 fabric

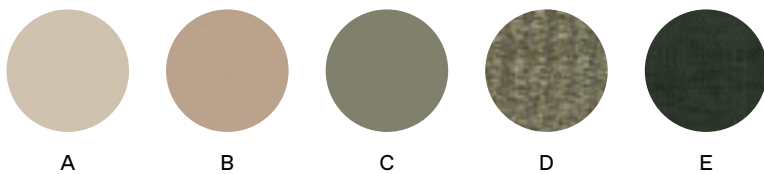

**Elementi / Elements:**

- 1 - Letto Sipario / Sipario bed
- 2 - Tavolino Tondo / Tondo coffee table
- 3 - Armadio sospeso Box / Suspended Box wardrobe
- 4 - Cabina Kubo / Kubo element
- 5 - Scrivania sospesa Kubo / Suspended desk Kubo
- 6 - Libreria Kubo / Kubo library



ITA Lo so, sono un tipo un po' strambo, ma cosa ci posso fare? Datemi qualche aggeggio elettronico, di quelli molto vintage, roba anni settanta-ottanta per intenderci, e mi farete contento. Datemi magari anche una moto, sempre di quegli anni lì e mi farete ancora più contento... anzi strafelice. Sono strambo ma ho gusti semplici, mi accontento di poco. Adesso però basta sognare, la dura realtà mi chiama: domani ho compito di Informatica, vi saluto che devo mettermi a studiare!

ENG I know, I'm a bit of a freak, but what can I do? Give me some electronic gadgets, those very vintage ones, something from the seventies and eighties to be precise, and I'll be happy. Maybe even give me a motorbike, again from those years, and I'll be even happier... or rather overjoyed. I'm weird but I have simple tastes, I'm content with little. But now, enough dreaming, the hard reality is calling me: tomorrow I have a test of Computer Science, I salute you, I have to start studying!











Giroletto 45° con gambe Kios, pannelli testiera Wall imbottiti in tessuto Bono TB26 ed Elba TB36./45° bed frame, upholstered headboard panels Wall in Bono TB26 and Elba TB36 fabric.





helvetica  
neue













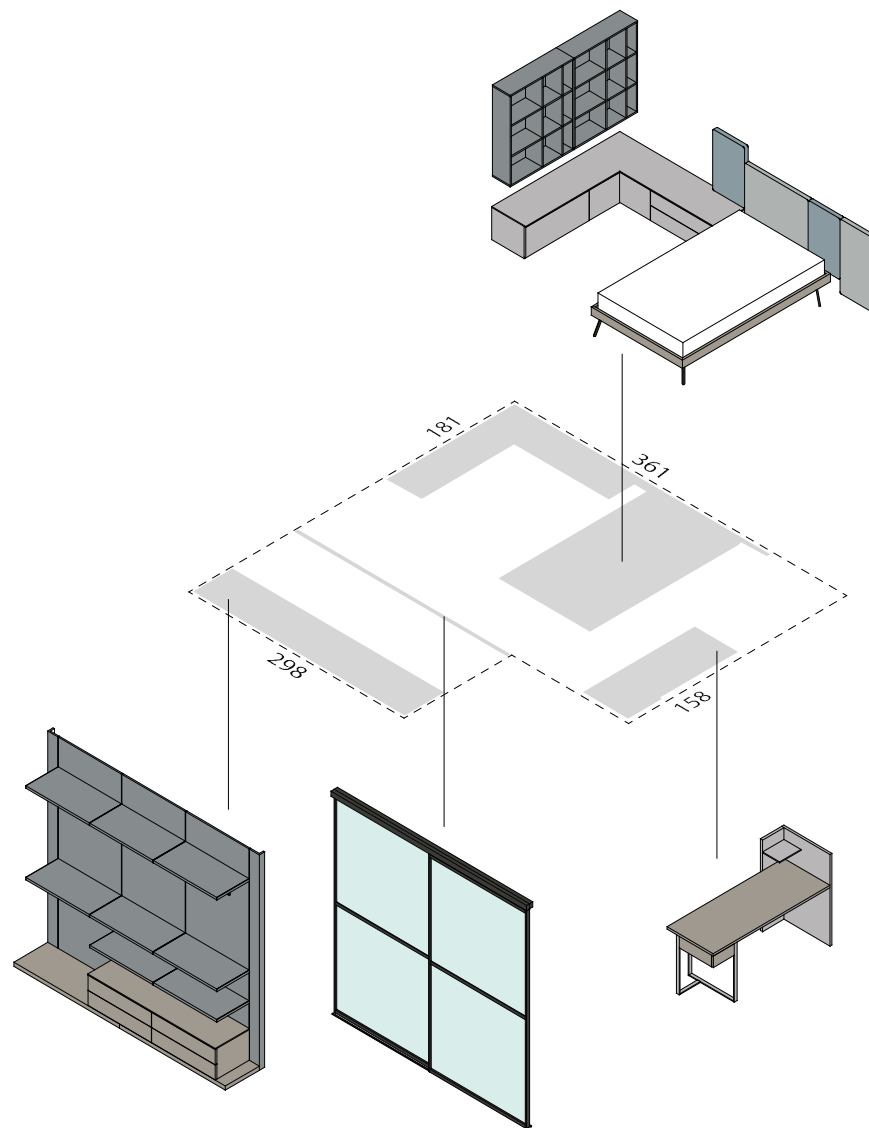

**Finiture / Finishes:**

- A - Melaminico Ossidato / Ossidato wood melamine
- B - Laccato Piuma / Piuma lacquered finish
- C - Laccato Nebbia / Nebbia lacquered finish
- D - Tessuto Bono TB26 / Bono TB26 fabric
- E - Tessuto Elba TB36 / Elba TB36 fabric

**Elementi / Elements:**

- 1 - Sistema letto Wall / Wall Bed System
- 2 - Sistema cabina Boiserie con portale scorrevole / Boiserie Walk-in Closet with Glass sliding doors
- 3 - Scrivania Isola / Isola desk
- 4 - Casellari Gate / Gate wall units



A



B



C

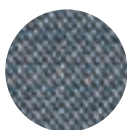

D



E

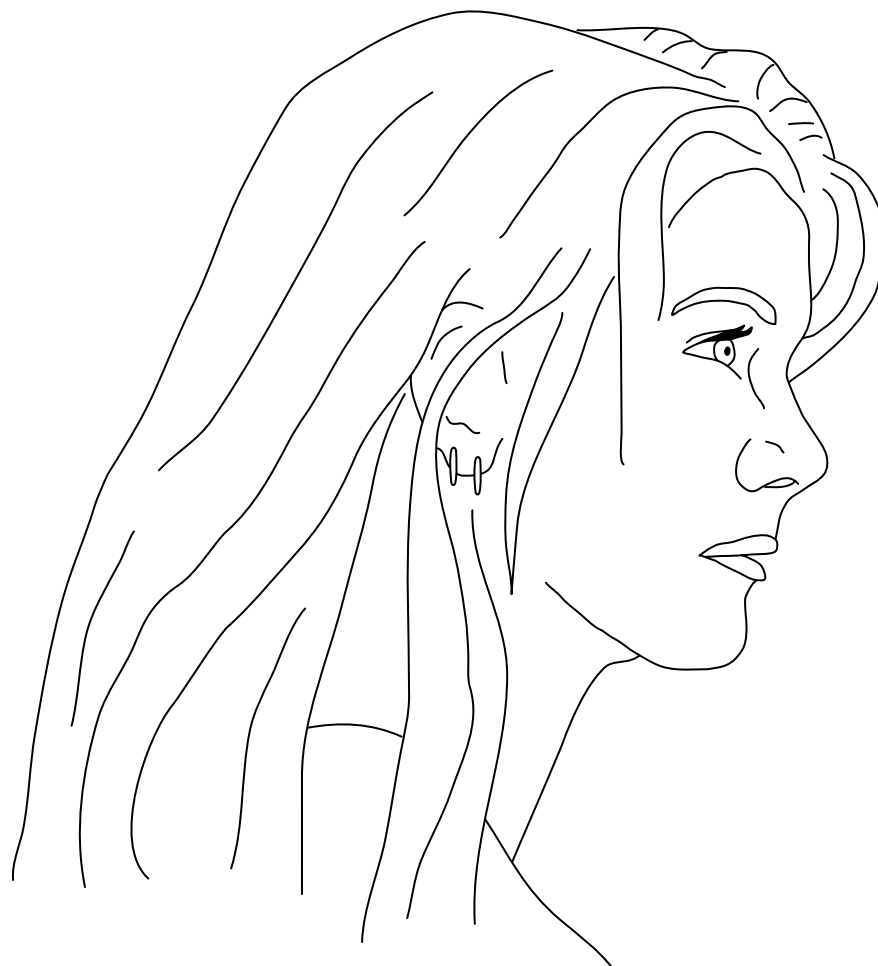

ITA Interno giorno, si vede la stanza di una giovane studentessa di Scienze della Formazione, innamorata dei romanzi di Murakami e dei film di Kubrick: modestamente, sono io. Questo è il mio rifugio personale, lo spazio dove mi sento me stessa, il set dove mi posso immergere nella lettura dell'ennesimo libro o nella visione di uno di quei film pazzeschi che piacciono solo a me. Del resto come diceva Jacques Tati (se non sapete chi era, andate su Wikipedia) "il cinema è una penna, della carta e delle ore a osservare le persone".

ENG Daytime interior, you see the room of a young student of Education Sciences, in love with Murakami's novels and Kubrick's films: modestly, that's me. This is my personal refuge, the space where I feel like myself, the set where I can immerse myself in reading yet another book or watching one of those crazy films that only I like. After all, as Jacques Tati used to say (if you don't know who he was, go to Wikipedia) "cinema is a pen, paper and hours spent observing people".









Zona studio composta da sistema pensili Sipario con ante sporgenti e retro illuminate, sistema Boiserie Orizzontale con mensole, piano scrittoio spess.50mm, gamba scrittoio in vetro./ Study area composed of Sipario wall units with protruding hinged doors and backlight, Boiserie system with shelves th.50mm, glass desk leg.

















Armadio Box attrezzato internamente di cassettera interna, Alveare e tubo appendiabiti.  
Maniglia Ghost 1200./Box wardrobe equipped with drawer pack, Alveare and one hanger tube.  
Ghost 1200 handle.





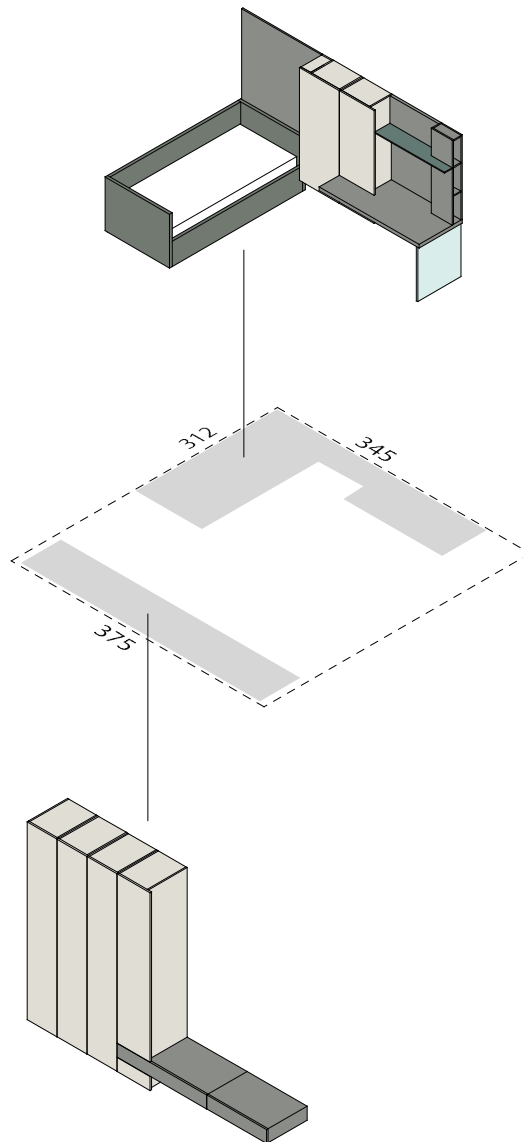

**Finiture / Finishes:**

- A - Melaminico Seta / Seta melamine
- B - Melaminico Petrolio / Petrolio melamine
- C - Laccato Piombo / Piombo lacquered finish
- D - Tessuto Mumble M021 / Mumble M021 fabric

**Elementi / Elements:**

- 1 - Divano letto imbottito Hinge / Hinge upholstered bed
- 2 - Pensili Sipario / Sipario wall units
- 3 - Armadio Box / Box wardrobe
- 4 - Armadio Sipario / Sipario wardrobe



A



B



C

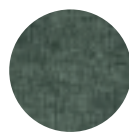

D

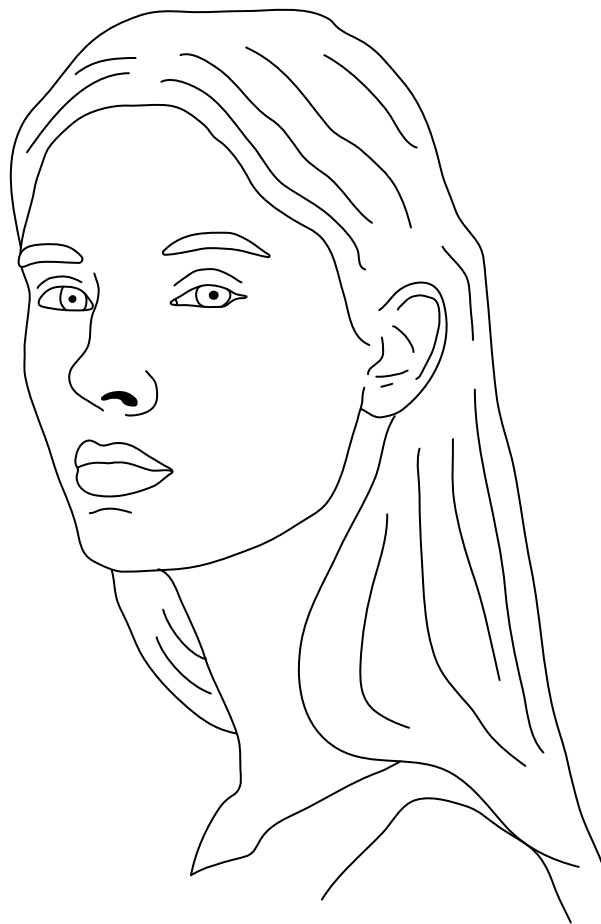

ITA Ma vi sembra possibile che proprio mentre sto sperimentando quell'effetto grafico incredibile, quella là si affaccia sulla porta e mi dice di rimettere a posto la stanza? E va bene, lo farò dopo. Adesso però devo finire ancora un paio di tavole e appenderle sulla parete. Accidenti, dove avrò messo il biadesivo? Era in questo cassetto, o forse è finito sotto il letto. E il taglierino, dove sarà andato a finire? Forse la mamma non ha tutti i torti... ma quando avrò il mio studio di design a New York, terrò tutto un po' più in ordine: lo prometto.

ENG But is it possible that just as I'm experimenting with that incredible graphic effect, that woman comes to the door and tells me to tidy up the room? All right, I'll do it later. Right now I have to finish a couple of more boards and hang them on the wall. Damn, where did I put the double-sided tape? It was in this drawer, or maybe it went under the bed. And the cutter, where did it go? Maybe mum's got a point... but when I get my own design studio in New York, I'll keep everything a bit tidier: I promise.









Letto Sipario con testiera imbottita in tessuto Mumble M018, giroletto raggiato con piedino in metallo Tondo. Libreria spalla sospesa prof.328mm./Sipario bed with upholstered headboard in Mumble M018, rounded bed frame with Tondo leg. Suspended library in 328mm depth.







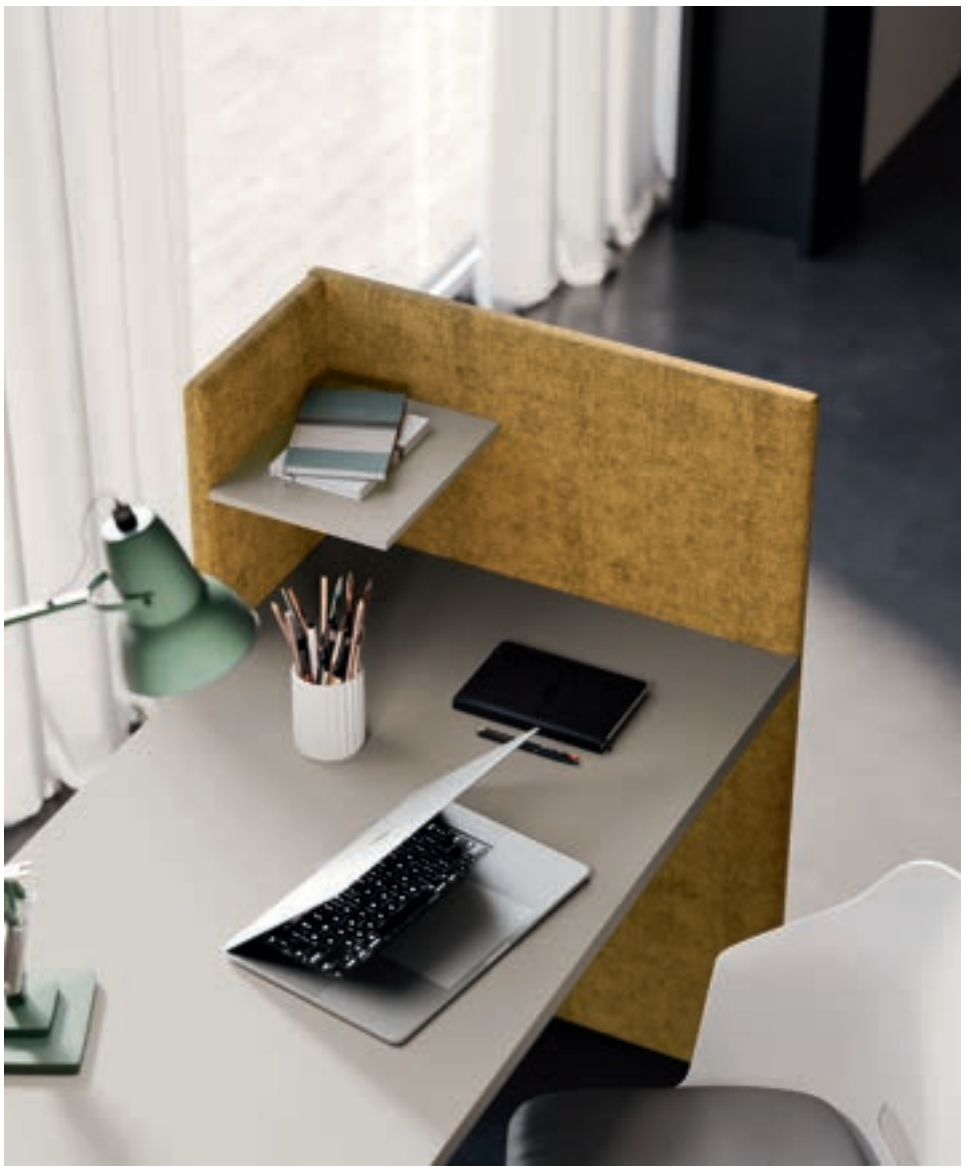

Scrittoio Isola con pannelli imbottiti in tessuto Mumble M018./Isola desk with upholstered panels in Mumble M018 fabric.







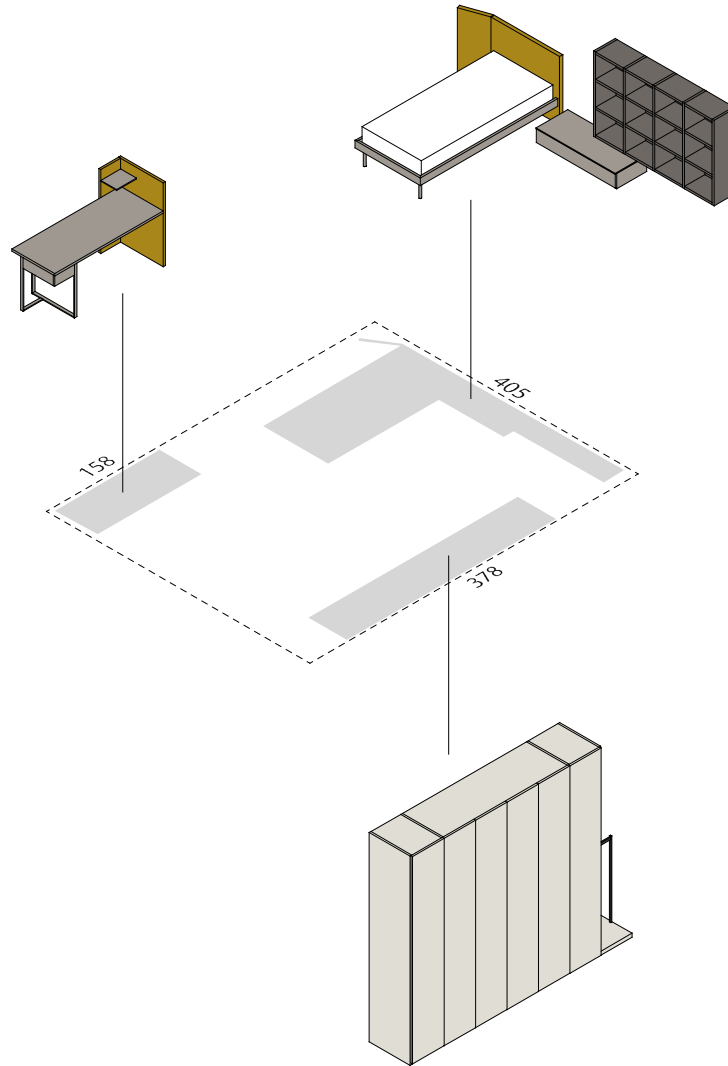

**Finiture / Finishes:**

- A - Melaminico Seta / Seta melamine
- B - Melaminico Platino / Platino melamine
- C - Laccato Antracite / Antracite lacquered finish
- D - Tessuto Mumble M018 / Mumble M018 fabric



A

B

C

D

**Elementi / Elements:**

- 1 - Letto Sipario / Sipario bed
- 2 - Libreria a spalla sospesa / Suspended library
- 3 - Armadio a spalla con cabina Best / Supporting side wardrobe with Best walk-in closet
- 4 - Scrivania Isola / Isola desk



ITA La vita in due non è sempre facile, soprattutto quando si è sorelle. Giorgia ha la mania degli animali, dice che da grande vuole fare la veterinaria: se fosse per lei riempirebbe la stanza di cani, gatti e criceti. Ma io non sono d'accordo e le dico: accontentati della tua collezione di peluche. In fondo sono la sorella più grande e quindi decido io... comunque abbiamo tutte e due il nostro spazio per le nostre passioni, i nostri libri, i nostri vestiti. L'importante è che non tocchi la mia pochette con i trucchi, o l'IIl become an animal!

ENG Life as a couple is not always easy, especially when you are sisters. Giorgia is obsessed with animals, she says she wants to be a vet when she grows up: if it were up to her she would fill her room with dogs, cats and hamsters. But I don't agree and tell her: be content with your collection of soft toys. After all, I'm her older sister, so I decide... anyway, we both have our own space for our passions, our books, our clothes. The important thing is that she doesn't touch my make-up bag, or I'll become an animal!













Letto XL per materasso da 1200mm con cassettoni estraibili, pannelli a muro con Cloud uso testiera imbottita e pensili sospesi Sipario con anta laccata Linea./XL bed for 1200mm mattress with movable drawers, wall panels with Cloud upholstered panels as headboard and Sipario wall units with Linea lacquered doors.





Zona studio composta da sistema Palko con scrittoio e pensili sospesi a giorno e cassettiere.  
/Study area composed of Palko system with desks, shelves and drawers.





Armadi Box attrezzati internamente di cassettiere, cestelli estraibili, tubi appendi abiti, affiancati a sistema Boiserie con mensole prof.250mm e colonne contenitori Sipario con ante sporgenti retro illuminate./ Box wardrobe equipped with drawer packs, movabl baskets and hanger tubes, horizontale Boiserie system with shelves and Sipario wardrobe with protruding hinged doors and backlight.





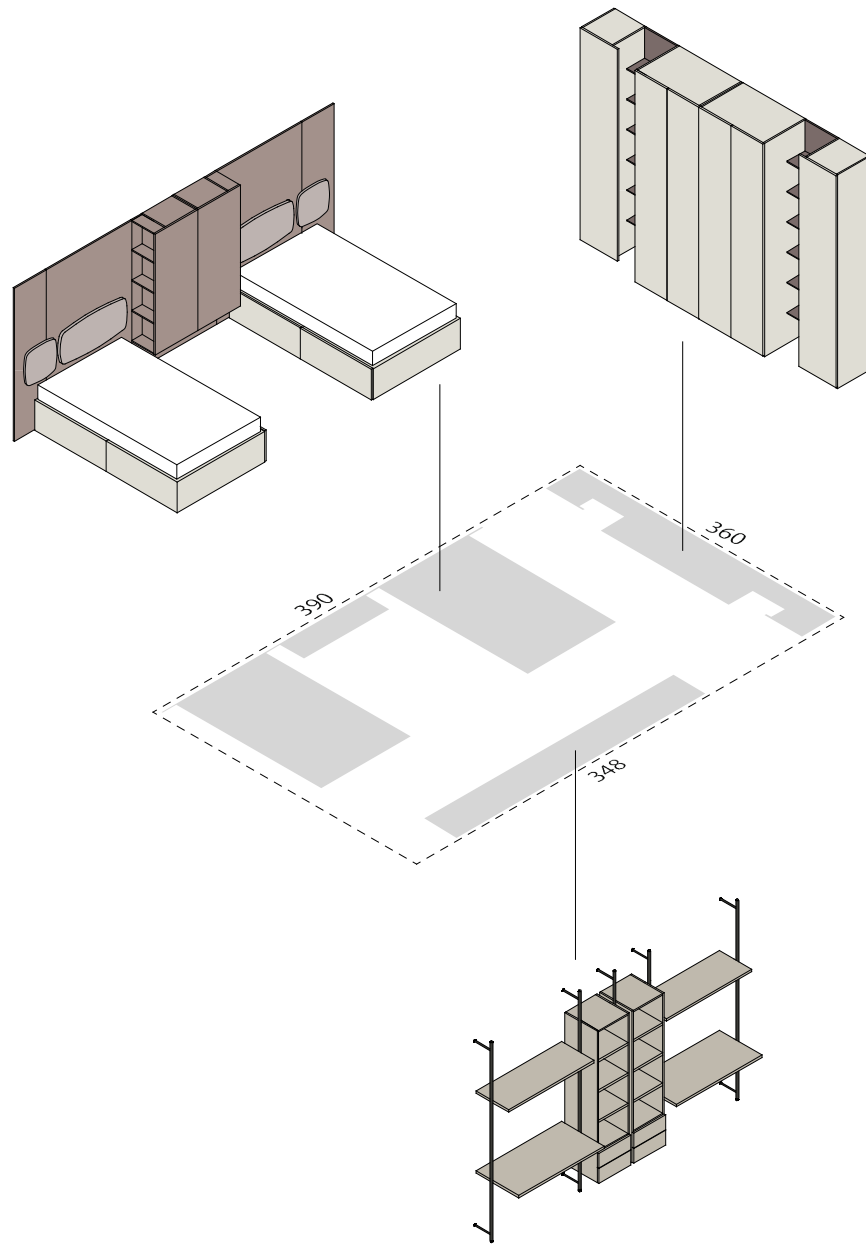

**Finiture/Finishes:**

- A - Melaminico Ossidato/Ossidato wood melamine
- B - Melaminico Seta/Seta melamine
- C - Laccato Ortensia/Ortensia lacquered finish
- D - Laccato Argilla/Argilla lacquered finish
- E - Tessuto Marmolada M002/Marmolada M002 fabric

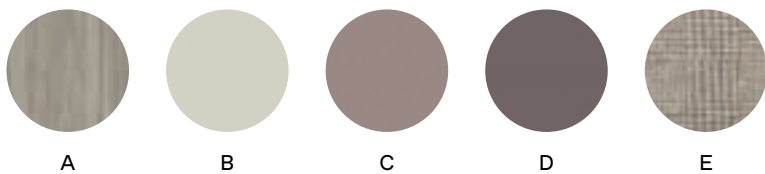

**Elementi/Elements:**

- 1 - Letti XL/XL beds
- 2 - Cabina Palko/Palko walk-in closet
- 3 - Armadi Box/Box wardrobe
- 4 - Contenitori Sipario/Sipario wall units

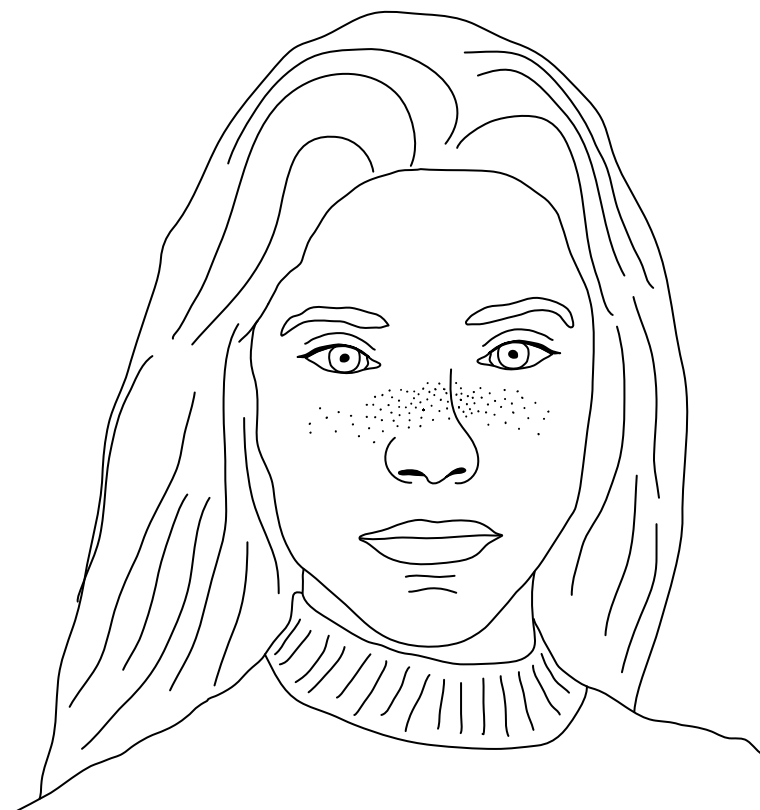

ITA Oh no, domani è venerdì e ho compito di latino... speriamo bene. Il fatto è che sabato avrò anche il saggio di pianoforte e se devo essere sincera, mi sono impegnata di più a studiare per quello. La mia vera passione è la musica, mi piace suonare e soprattutto cantare, fino da quando ero bambina. Lo so che è una carriera difficile, ma non è bello sognare un po'? E poi chissà che non diventi una cantante famosa, un giorno... nel frattempo mi faccio coraggio e affronto la versione di Orazio... in fondo anche nel latino c'è un po' di musica.

ENG Oh no, tomorrow is Friday and I have a Latin test... let's hope well. The thing is that on Saturday I'll also have my piano recital and if I have to be honest, I've put more effort into studying for that. My real passion is music, I like playing and especially singing, ever since I was a child. I know it's a difficult career, but isn't it nice to dream a little? And who knows, maybe one day I'll become a famous singer... in the meantime, I'll work up the courage to take on Horace's version... after all, there is a bit of music in Latin too.









Giroletto 45° con piedi Kios, pannelli Wall imbottiti in tessuto Sarin S306 e Demetra D031, basi a terra uso comodino con maniglia C16./45° bed frame with Kios legs, Wall upholstered panels in Sarin S306 and Demetra D031 fabric, base units with C16 handle.







Zona studio composta da piano scrittoio sp.30mm, casellari Kios, basi sospese con cassetti.  
/Study area composed of th.30mm desk, Kios wall units and suspended units with drawers.









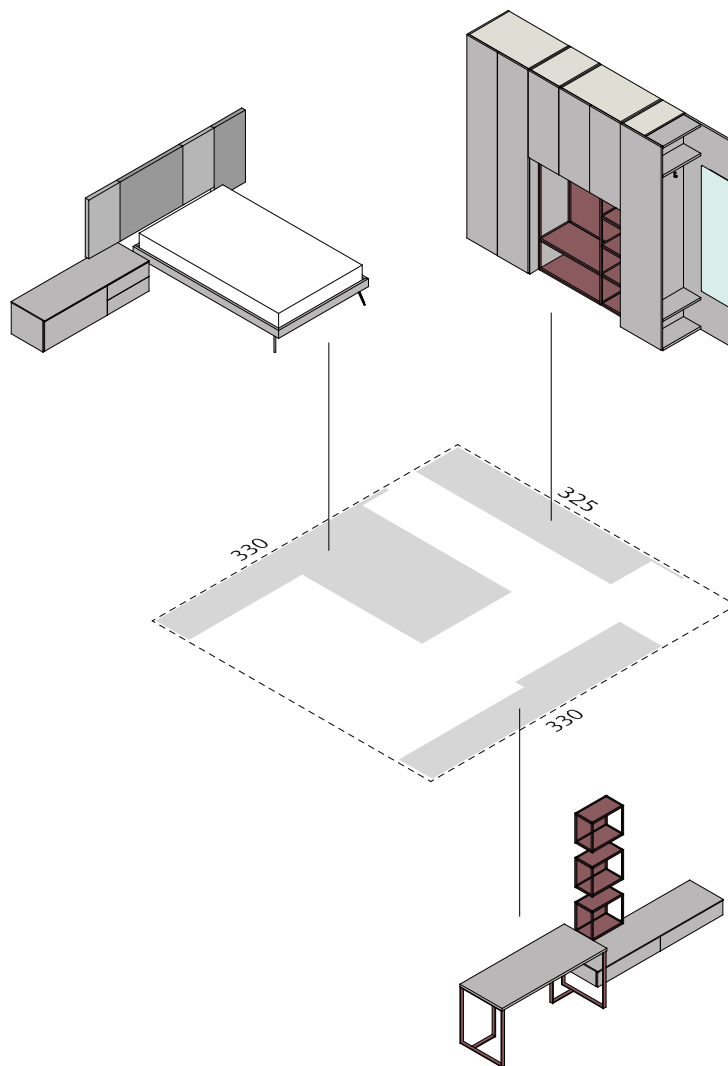

**Finiture/Finishes:**

- A - Melaminico Seta/Seta melamine
- B - Laccato Piuma/Piuma lacquered finish
- C - Laccato Prugna/Prugna lacquered finish
- D - Tessuto Sarin S306/Sarin S306 fabric
- E - Tessuto Demetra D031/Demetra D031 fabric



A

B

C

D

E

**Elementi/Elements:**

- 1 - Letto sistema Wall/Wall bed system
- 2 - Armadio Box/Box wardrobe
- 3 - Cabina Kios/Kios cabinet
- 4 - Scrivania Kios/Kios desk
- 5 - Casellari Kios/Kios wall units



ITA Sul mio futuro ho le idee molto chiare: quando avrò finito il liceo, mi iscriverò a Medicina. Voglio diventare un chirurgo e quindi mi devo preparare ad anni e anni di studio... ma non mi dispiace, anzi mi appassiona. Mi sto documentando anche sull'Africa, perché dopo la laurea, voglio fare un periodo di volontariato. Insomma mi aspetta un periodo importante, ma io mi sento pieno di energie: e comunque trovo sempre il tempo per rilassarmi un po', leggere, vedere i miei amici.

ENG I have very clear ideas about my future: when I finish high school, I'm going to study medicine. I want to become a surgeon and so I have to prepare myself for years and years of study... but I don't mind, in fact I'm passionate about it. I am also reading up on Africa, because after graduating, I want to do some voluntary work. In short, I have an important period ahead of me, but I feel full of energy: and in any case I always find time to relax a bit, read, see my friends.











Divano letto Apollo con cassettoni estraibili./Apollo bed with movable drawers.











Zona studio composta da colonne Sipario con ante battenti sporgenti retro illuminate, piano scrittoio sp.50mm, sistema Boiserie orizzontale con mensole./Study area composed of Sipario elements with protruding hinged doors and backlight, th.50mm desk, horizontal Boiserie system with shelves.





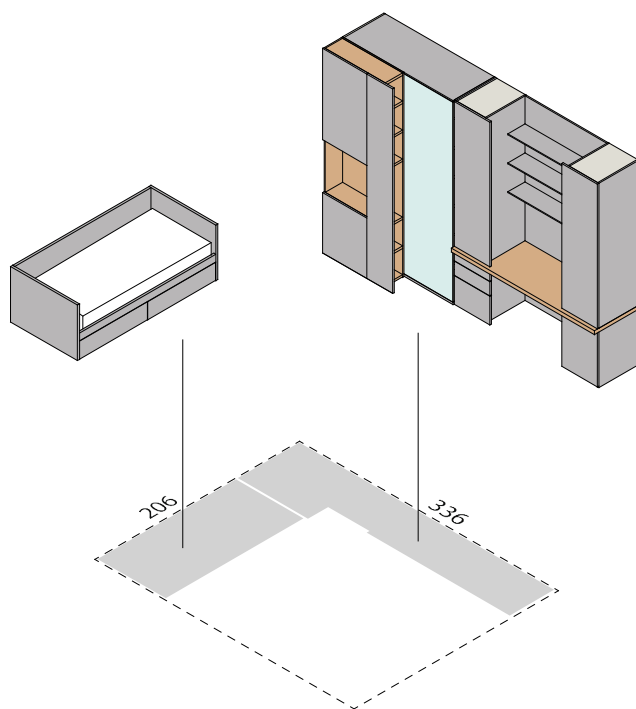

**Finiture / Finishes:**

- A - Melaminico Rovere / Rovere wood melamine
- B - Laccato Piuma / Piuma lacquered finish
- C - Laccato Nebbia / Nebbia lacquered finish

**Elementi / Elements:**

- 1 - Divano letto Apollo / Apollo bed
- 2 - Cabina Gulliver / Gulliver wardrobe
- 3 - Sistema Sipario / Sipario system



A



B



C

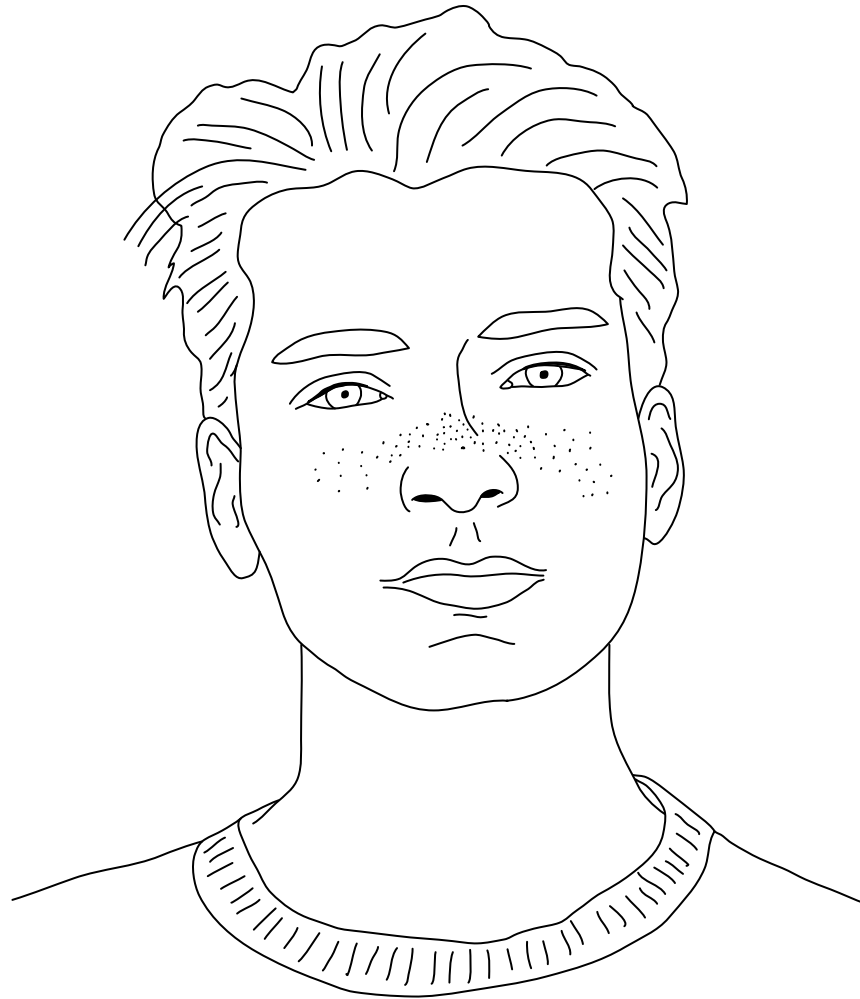

ITA Lunedì, total body workout. Martedì, cardio. Mercoledì, bodyweight. Giovedì, addominali e gambe. Venerdì, cioè oggi, calcetto con gli amici. Lo so, dovrei rallentare un po' il ritmo, i muscoli avrebbero bisogno di recuperare e la mente anche. Ci sono pure gli esami a Ingegneria, però io non riesco proprio a stare fermo, sono fatto così. Accidenti, che ore sono? Mi devo preparare per la partita. Prima però un po' di relax, metto su un po' di musica e mi distendo sul letto... sperando di non addormentarmi.

ENG Monday, total body workout. Tuesday, cardio. Wednesday, bodyweight. Thursday, abs and legs. Friday, i.e. today, five-a-side with friends. I know, I should slow down a bit, my muscles might need to recover and my mind too. There are also exams in Engineering, but I just can't stay still, that's how I am. Damn, what time is it? I have to prepare for the game. But first a bit of relaxation, I put some music on and lie down on the bed... hoping not to fall asleep.











Letto Soter con giroletto 45°./Soter bed with 45° bed frame.



Mensole Snake sp.50mm, scrittoio sp.50mm in appoggio a colonne Sipario con ante sporgenti retroilluminate./Snake shelves th.50mm, th50mm desk, Sipario wardrobe with protruding hinged door and backlight.







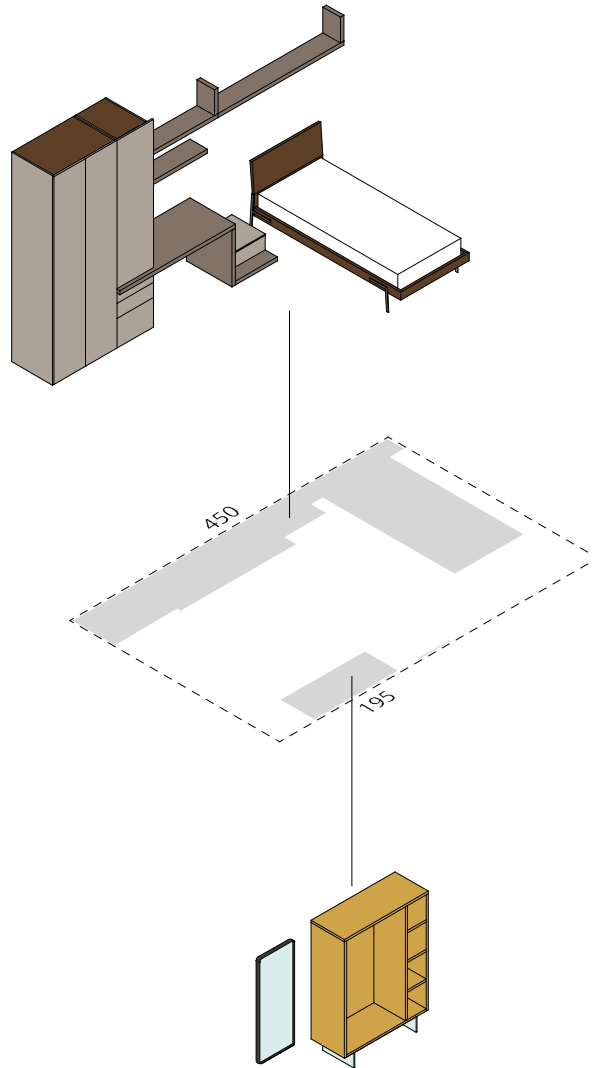

**Finiture / Finishes:**

- A - Melaminico Cotto / Cotto wood melamine
- B - Dekor Avana
- C - Laccato Terra / Terra lacquered finish
- D - Melaminico Curcuma / Curcuma melamine

**Elementi / Elements:**

- 1 - Letto Soter / Soter bed
- 2 - Armadi Box / Box wardrobe
- 3 - Armadi Sipario / Sipario wardrobe
- 4 - Elemento Kube / Kube element



A



B



C



D



ITA Accidenti che domenica ho passato, non vedo l'ora di mettermi a letto. Tutta la mattina al centro commerciale e il pomeriggio a studiare matematica. I miei brontolano: "cosa ti sei messa in testa di lavorare il fine settimana in quel negozio di abbigliamento?" Ma io li lascio dire, a me piace così, anche se ho poco tempo per le amiche. Metto da parte qualche soldino per l'università, faccio curriculum e magari questa estate, mi concedo un bel viaggio... intanto volo nel mondo dei sogni, buonanotte!

ENG Damn what a Sunday I've had, I can't wait to get to bed. All morning at the mall and the afternoon studying maths. My parents grumble: "What were you thinking, working at that clothing shop on the weekend?" But I let them talk, I like it that way, even if I have little time for friends. I'll save up some money for university, do my curriculum and maybe this summer I'll treat myself to a nice trip... in the meantime I'm flying to the world of dreams, good night!









Turca imbottita in tessuto Demetra D031 con contenitore e meccanismo di apertura verticale.  
Testiera letto imbottita in tessuto Kora K006, con pensili laterali Sipario uso comodino./Turca  
bed in Demetra D031 fabric, with bed base lift-up mechanism. Upholstered headboard in Kora  
K006 fabric with Sipario wall unit used as night table.















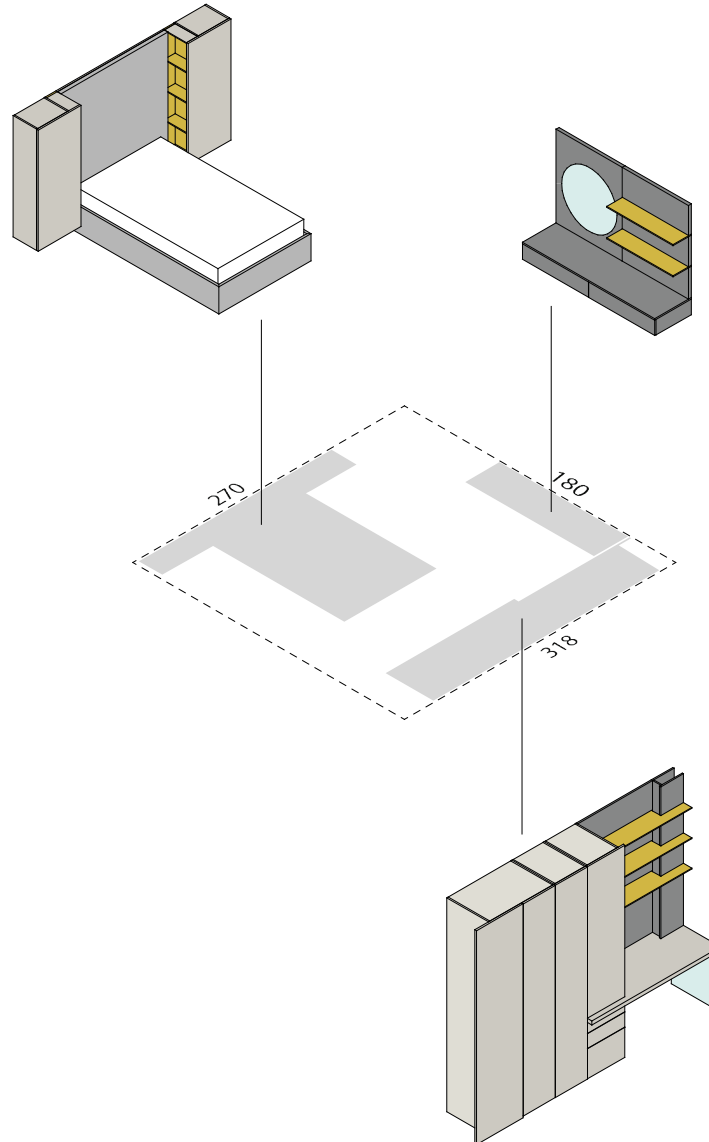

**Finiture/Finishes:**

- A - Laccato Perla/Perla lacquered finish
- B - Melaminico Grigio/Grigio melamine
- C - Laccato Miele/Miele lacquered finish
- D - Tessuto Demetra D031/Demetra D031 fabric
- E - Tessuto Kora K006/Kora K006 fabric



A



B



C

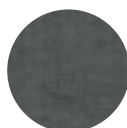

D

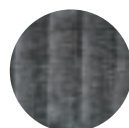

E

**Elementi/Elements:**

- 1 - Turca imbottita/Turca upholstered bed
- 2 - Armadio Box/Box wardrobe
- 3 - Armadio Sipario/Sipario wardrobe
- 4 - Sistema Sipario/Sipario system
- 5 - Sistema Boiserie orizzontale/Horizontal Boiserie system

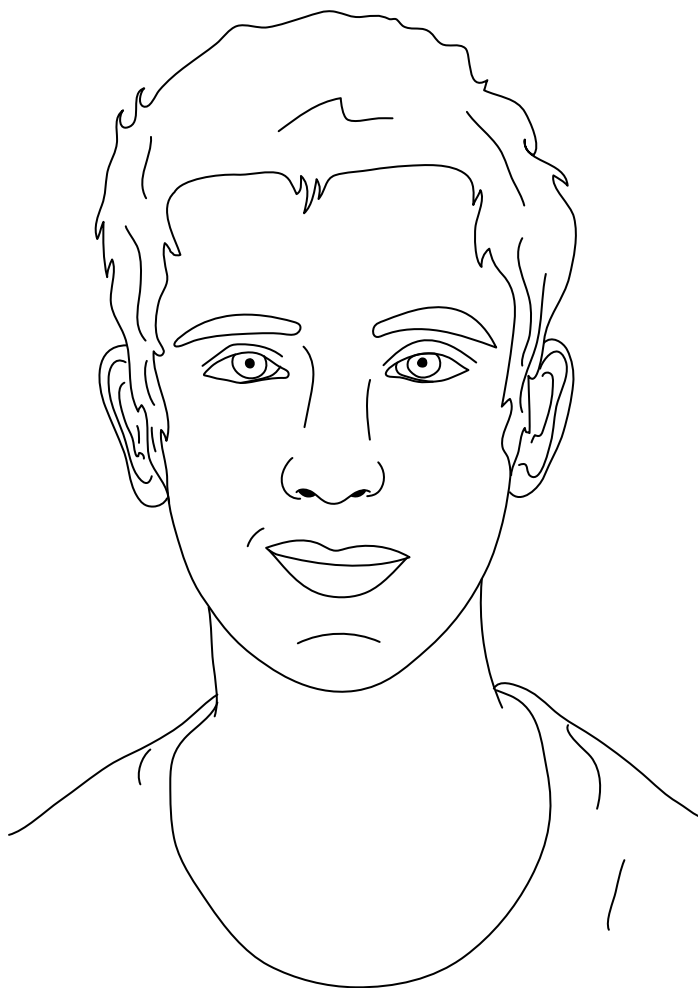

ITA Sono un tipo che va al sodo, la filosofia non fa per me. Preferisco l'hardware, il software, le periferiche, un modem da smontare e aggiustare, un sistema operativo da sistemare, un malware da snidare. Datemi una stampante impazzita, uno scanner che non ne vuole sapere di funzionare, un disco rigido che è andato in palla: ci penso io. Non per vantarmi, ma ormai tutti i clienti del negozio vogliono solo me. E poi parliamoci chiaro: anche per scrivere un libro di filosofia, ci vuole un computer che funziona.

ENG I'm a straightforward guy, philosophy is not my thing. I prefer hardware, software, peripherals, a modem to be disassembled and repaired, an operating system to be fixed, malware to be hunted down. Give me a crazy printer, a scanner that doesn't want to know about functioning, a hard disk that has crashed: I'll take care of it. I don't want to brag, but nowadays all the customers in the shop want only me. And let's face it: even to write a philosophy book, you need a computer that works.













Letto Slitta imbottito in tessuto Demetra D022 con piede in metallo Tondo, comodino Kios con cassetto./Slitta upholstered bed in Demetra D022 fabric with Tondo legs, Kios night table with drawer.

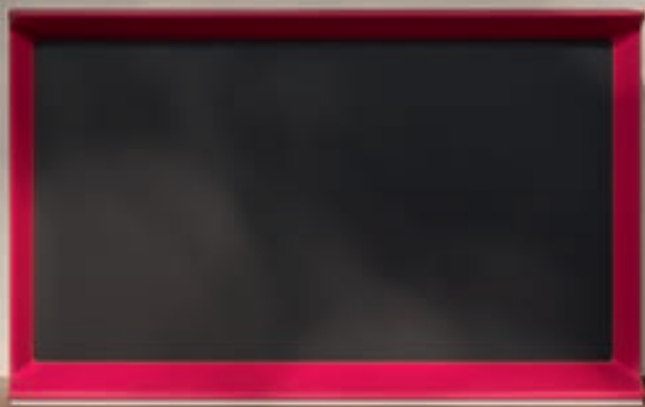
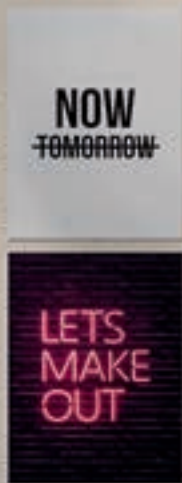









Armadio scorrevole Ghost 1200, attrezzato con divisori e ripiani, porta pantaloni e servetto.  
/Ghost 1200 sliding door wardrobe, equipped with shelves, trouser rack and Servetto hanger tube.



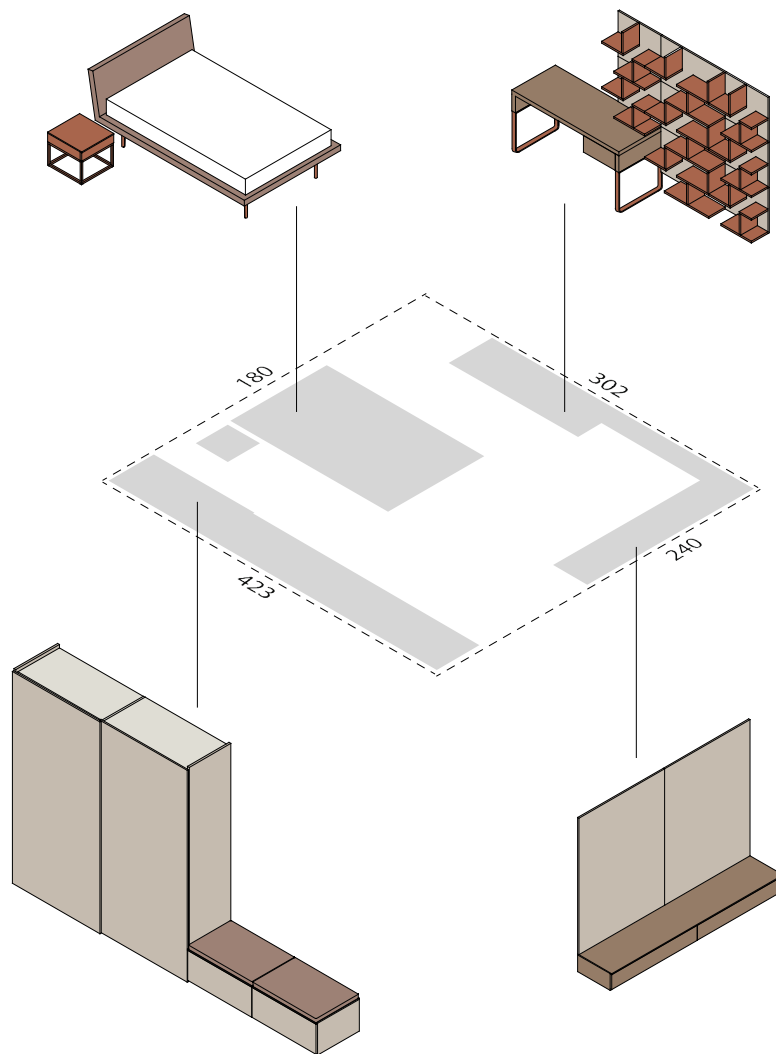

**Finiture / Finishes:**

- A - Melaminico Noce / Noce wood melamine
- B - Dekor Canapa
- C - Laccato Cannella / Cannella lacquered finish
- D - Tessuto Demetra D022 / Demetra D022 fabric



A



B



C



D

**Elementi / Elements:**

- 1 - Letto Slitta / Slitta bed
- 2 - Comodino Kios / Kios night table
- 3 - Armadio scorrevole Ghost 1200 / Ghost 1200 sliding door wardrobe
- 4 - Scrivania Slitta / Slitta desk
- 5 - Casellari Cross / Cross wall units

ITA Una soluzione pratica che integra, in un'unica composizione, le funzioni principali di una camera singola o doppia. Contiene, dormire, studiare: tutto in uno spazio ideale e con una filosofia contemporanea, fatta di linee essenziali e di alternanza dinamica fra volumi sospesi ed a terra, vani chiusi ed a giorno, citazioni dal mondo dell'home office e dei negozi di tendenza, sensazioni naturali e piacevoli abbinamenti cromatici. La camera dei ragazzi così strutturata diventa un'architettura nell'architettura, una città dove i sogni prendono forme concrete, intelligenti e amichevoli: per immaginare il domani, ogni giorno.

ENG A practical solution, that integrates, in a single composition, the main functions of a single or double room. To contain, to sleep, to study: all in an ideal space and with a contemporary philosophy, made up of essential lines and dynamic alternation between suspended and floor-standing volumes, closed and open compartments, quotations from the world of the home office and trendy shops, natural sensations and pleasant colour combinations. The children's room thus structured becomes an architecture within an architecture, a city where dreams take concrete, intelligent and friendly forms: to imagine the future, every day.



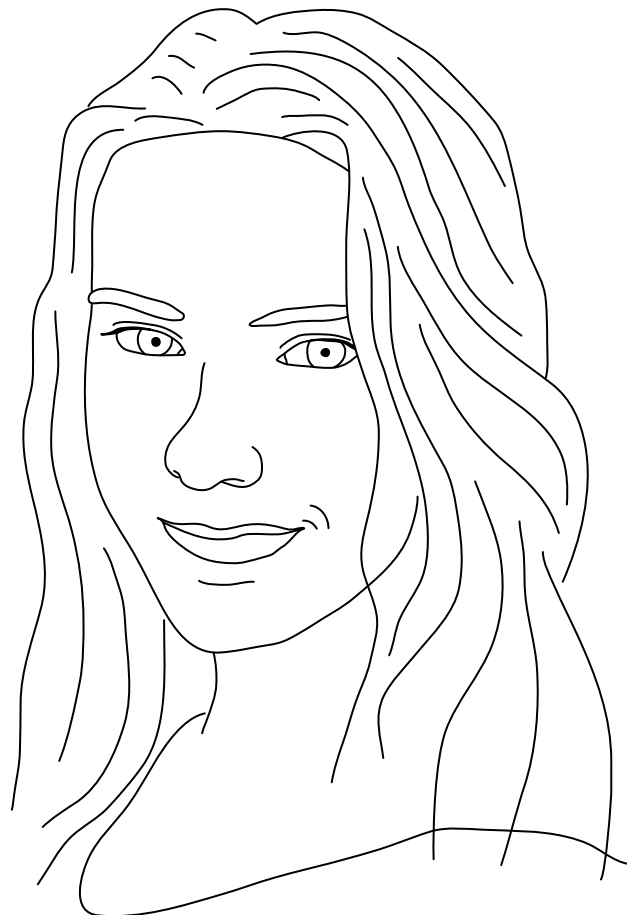

ITA Ho due passioni nella vita: la cucina e il fantasy. Non lo so se mi dà più emozione scoprire una ricetta pazzesca, mai vista nè provata prima, oppure guardarmi per l'ennesima volta la trilogia del Signore degli Anelli. A scuola mi dicono che sono un po' strana, ma in fondo le grandi donne chef hanno tutte una personalità speciale, no? Carattere, talento, personalità, fantasia e magia ci vogliono in cucina. Un giorno anche io avrò un ristorante a 3 stelle, anzi ho già deciso il nome: lo chiamerò Galadriel.

ENG I have two passions in life: cooking and fantasy. I don't know if I'm more excited about discovering a crazy recipe that I've never seen or tried before, or watching the Lord of the Rings trilogy for the umpteenth time. At school they tell me I'm a bit weird, but after all, great women chefs all have special personalities, don't they? Character, talent, personality, imagination and magic are all needed in the kitchen. One day I too will have a three-star restaurant, and I have already decided on the name: I will call it Galadriel.













Letto Botton imbottito in tessuto Sarin S305 con piede Tondo laccato Cannella./Botton upholstered bed in Sarin S305 fabric, with Tondo leg in Cannella lacquered finish.



Cabina Palko attrezzata di ripiani con tubi appendi abiti, illuminazione verticale, base a terra con cassetti e specchio./Palko walk-in closet equipped with shelves, hanger tubes, vertical lighting, base unit with drawers and mirror.



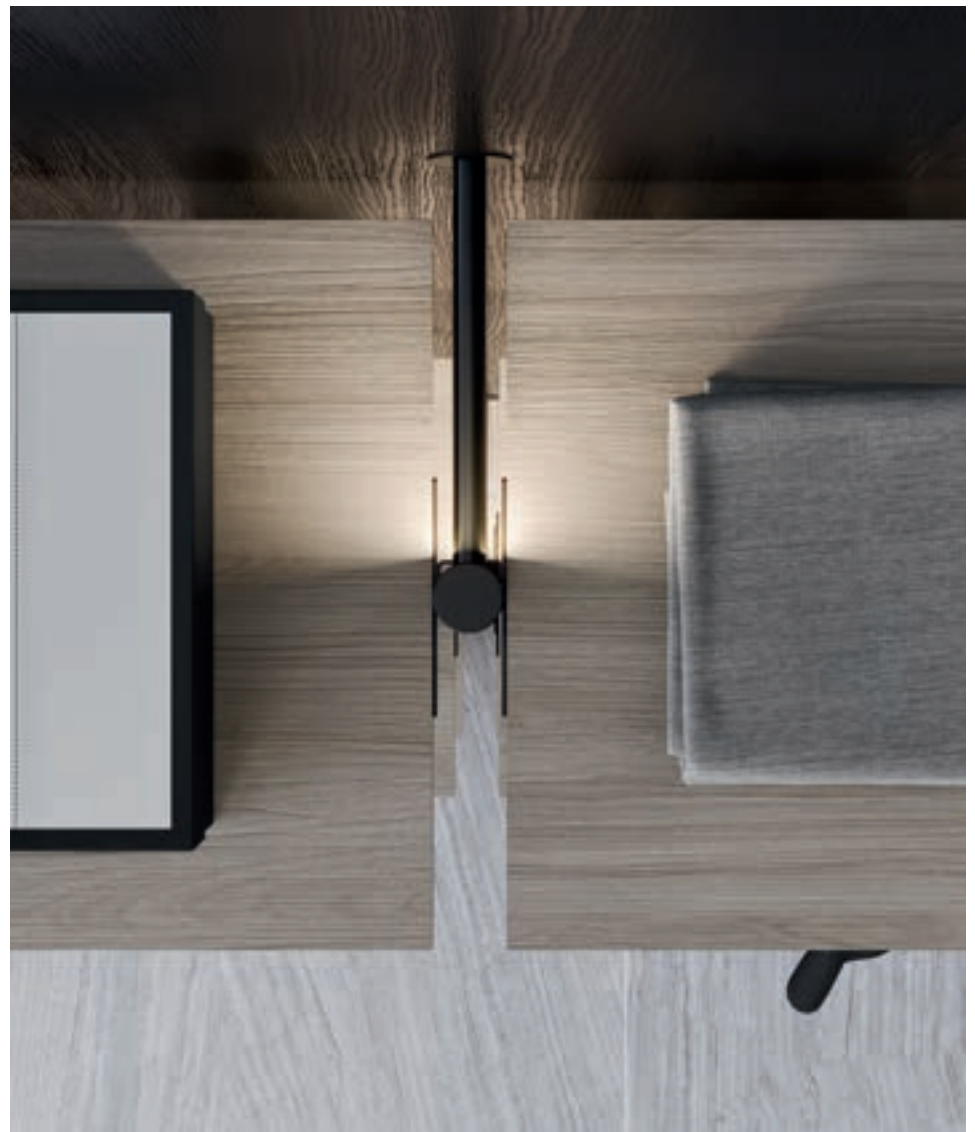

Cabina Palko predisposta di piede a terra regolabile, ancoraggio a muro, staffe supporta mensole e retroilluminazione led./Palko walk-in closet made of height-adjustable ground base, wall fixation elements, brackets for shelves support and led backlight.

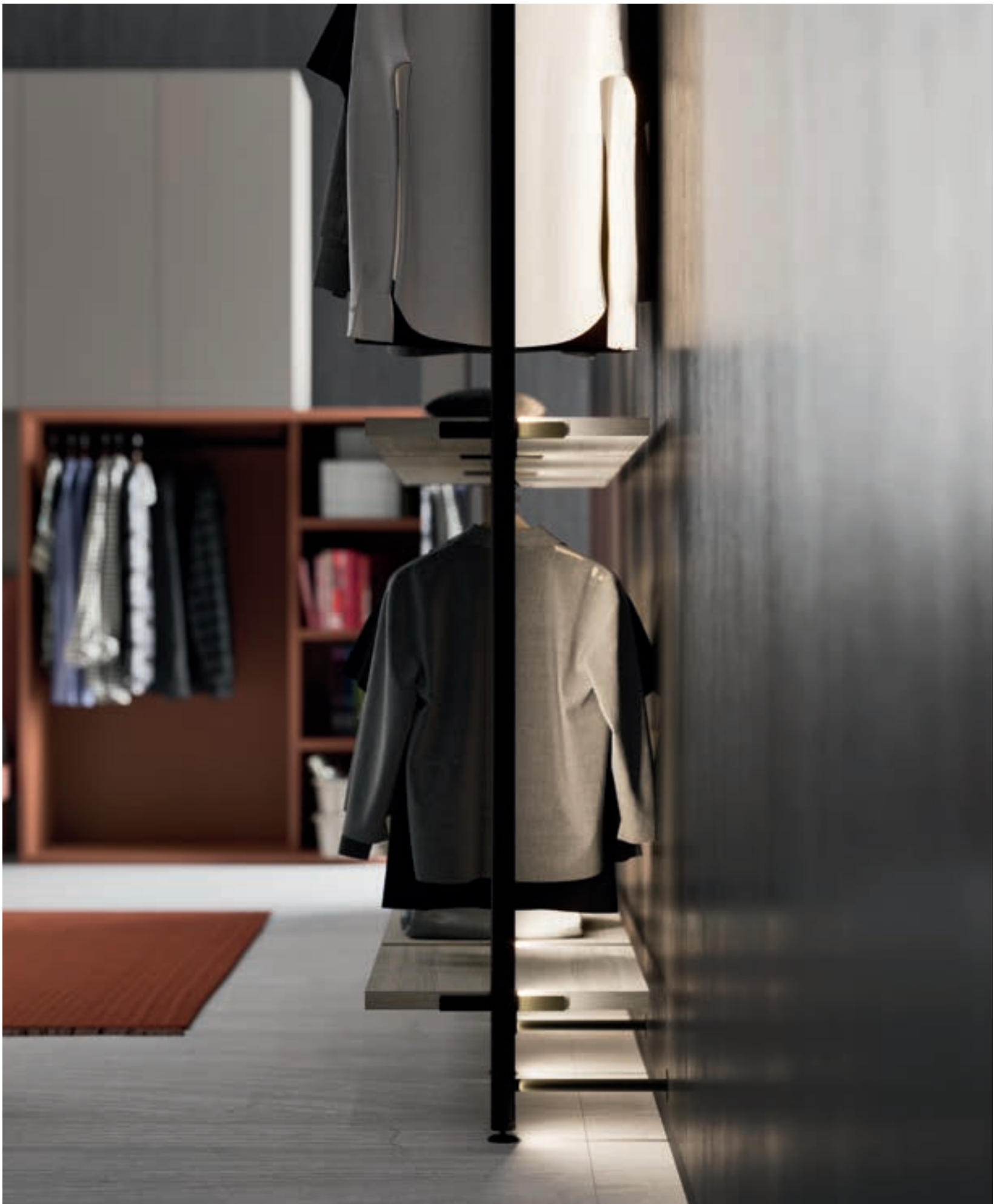



Cabina Kubo con ripiani e tubo appendiabiti./Kubo closet with shelves and hanger tube.



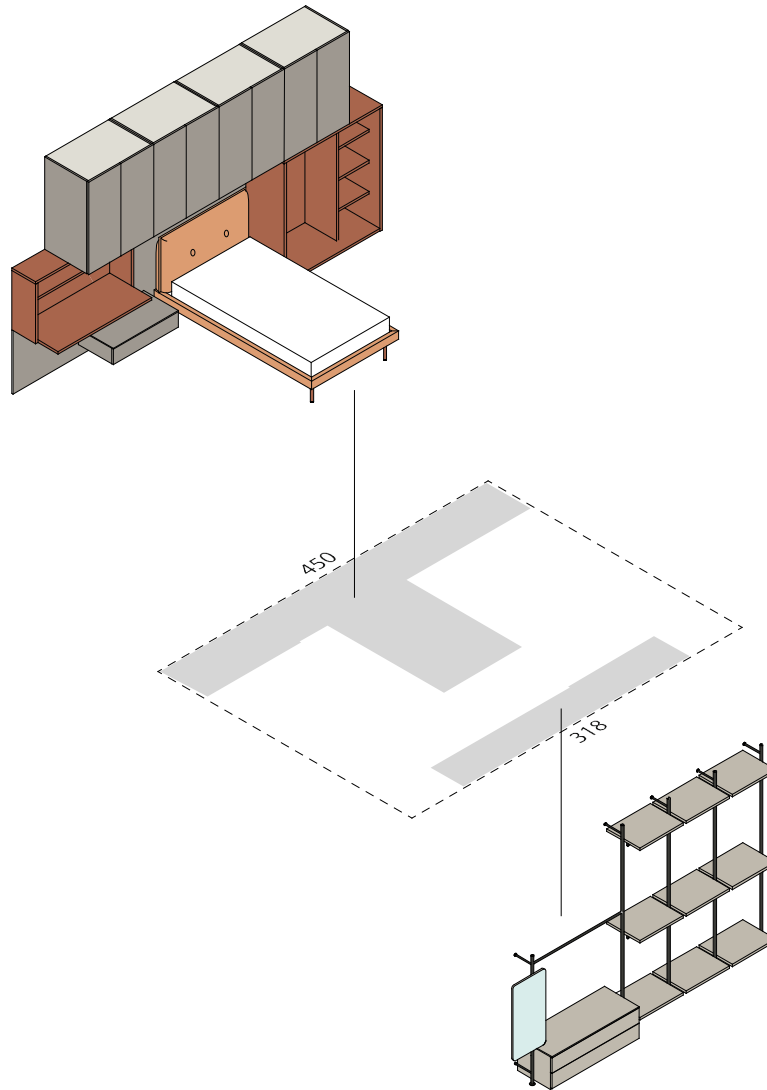

**Finiture / Finishes:**

- A - Melaminico Ossidato / Ossidato wood melamine
- B - Melaminico Platino / Platino melamine
- C - Laccato Cannella / Cannella lacquered finish
- D - Tessuto Sarin S305 / Sarin S305 fabric



A

B

C

D

Ponti / Bridges

**Elementi / Elements:**

- 1 - Letto Botton imbottito / Botton upholstered bed
- 2 - Ponte Blok / Blok bridge
- 3 - Scrivania Kubo / Kubo desk
- 4 - Cabina Kubo / Kubo closet
- 5 - Cabina Palko / Palko walk-in closet

S22\_P13



ITA Watashi wa Alessandro desu, itariajin desu... accidenti, sapevo che il giapponese era un po' complicato, ma già dalla prima lezione mi fuma la testa. Però quando arriverò a Tokio, non voglio essere impreparato. È tutta la vita che voglio fare questo viaggio: e sarà solo il primo di una lunga serie. Mi affascinano anche il Medio Oriente, il Sud America, l'Australia... insomma, per farla breve, vorrei girare tutto il mondo! Per fortuna che ho una predisposizione pazzesca per le lingue: sono proprio nato per viaggiare.

ENG Watashi wa Alessandro desu, itariajin desu... Damn, I knew that Japanese was a bit complicated, but already from the first lesson my head is blowing up. But when I get to Tokyo, I don't want to be unprepared. I've been wanting to make this trip all my life, and it will only be the first in a long series. I'm also fascinated by the Middle East, South America, Australia... in short, I'd like to travel the whole world! Luckily, I have a crazy flair for languages: I was born to travel.









Letto XL con cassettoni, fianco testata letto spess.50mm. e pannelli Cloud imbottiti e rivestiti con tessuto Sarin S304./XL bed with drawers, th.50mm side panel, Cloud upholstered panels in Sarin S304 fabric.





Cabina Gulliver con anta scorrevole in vetro trasparente e telaio brunito, attrezzata di ripiani e tubi appendiabiti./Gulliver wardrobe with sliding door in transparent glass and burnished frame, equipped with shelves and hanger tubes.







Colonna Visual con pannello orientabile porta TV, cassettoni e ante battenti./Visual wardrobe with adjustable TV stand panel, drawers and hinged doors.





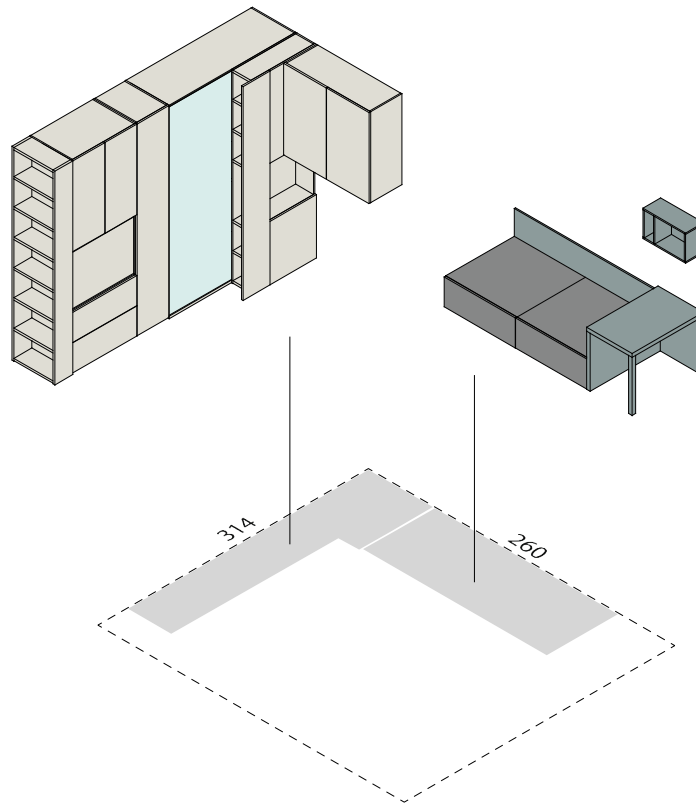

**Finiture / Finishes:**

- A - Melaminico Seta / Seta melamine
- B - Melaminico Grigio / Grigio melamine
- C - Melaminico Petrolio / Petrolio melamine
- D - Tessuto Sarin S304 / Sarin S304 fabric



A



B



C

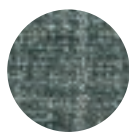

D

**Elementi / Elements:**

- 1 - Letto XL / XL bed
- 2 - Cabina armadio Gulliver / Gulliver wardrobe
- 3 - Armadio Box Visual / Box visual wardrobe
- 4 - Pensili / Wall units
- 5 - Terminale libreria / Library end module



ITA Ma che ora è? Ieri sera ho fatto un po' tardi, ma dopo avere vinto la partita di pallavolo, non potevo tirarmi indietro: tutta la squadra a cena e poi via, pazzia gioia e ore piccole! Ve bene così dai: è una bella mattina di sole e resto a letto ancora un po', mentre mi programmo la giornata. Mi prendo una pausa, guardo una serie su Netflix, faccio qualche telefonata alle amiche e intanto mi rimetto in sesto. E poi sotto con la biofisica molecolare, che l'esame si avvicina... batti un cinque!

ENG But what time is it? Last night it was a bit late, but after winning the volleyball match, I couldn't back out: the whole team to dinner and then off, mad joy and late hours! It's fine: it's a beautiful sunny morning and I stay in bed a little longer, while I plan my day. I take a break, watch a series on Netflix, make a few phone calls to friends and in the meantime I get myself together. And then it's on to molecular biophysics as the exam approaches.... high five!











Libreria Spalla bifacciale accostata su un lato da scrittoio Kios in appoggio a basi a terra e dall'altro lato dal letto Narvi con comodino./Double sided library with Kios desk, base units and Narvi bed with night table.







Ponte Blok composto da elementi con ripiani e tubi appendiabiti, panca a terra con basi in appoggio./ Blok bridge composed of elements with shelves and hanger tubes, ground bench with base units.



Letto imbottito Narvi rivestito in tessuto Mumble M014 con piede Tondo./Narvi upholstered bed in Mumble M014 fabric with Tondo legs.







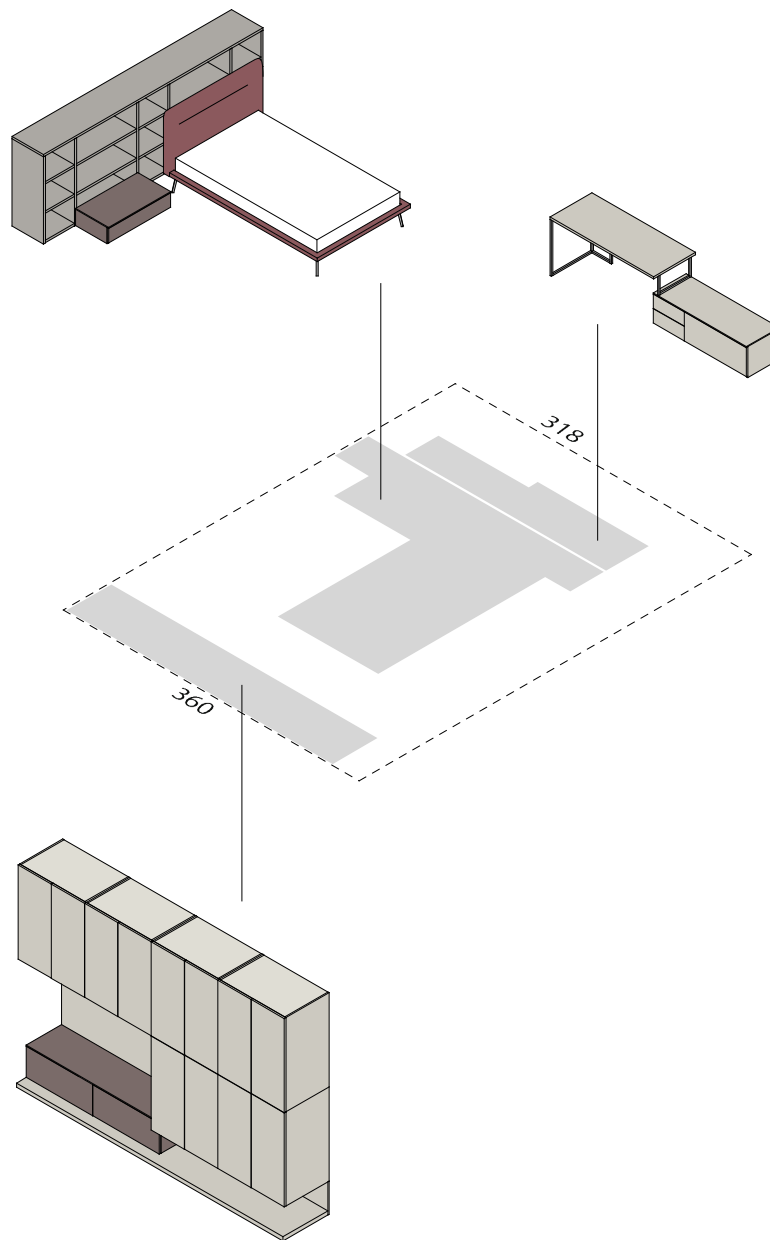

**Finiture / Finishes:**

- A - Melaminico Ossidato / Ossidato wood melamine
- B - Laccato Perla / Perla lacquered finish
- C - Laccato Argilla / Argilla lacquered finish
- D - Tessuto Mumble M014 / Mumble M014 fabric



A



B



C



D

**Elementi / Elements:**

- 1 - Letto imbottito Narvi / Narvi upholstered bed
- 2 - Ponte Blok / Blok bridge
- 3 - Libreria spalla bifacciale / Double sided library
- 4 - Scrivania Kios / Kios desk

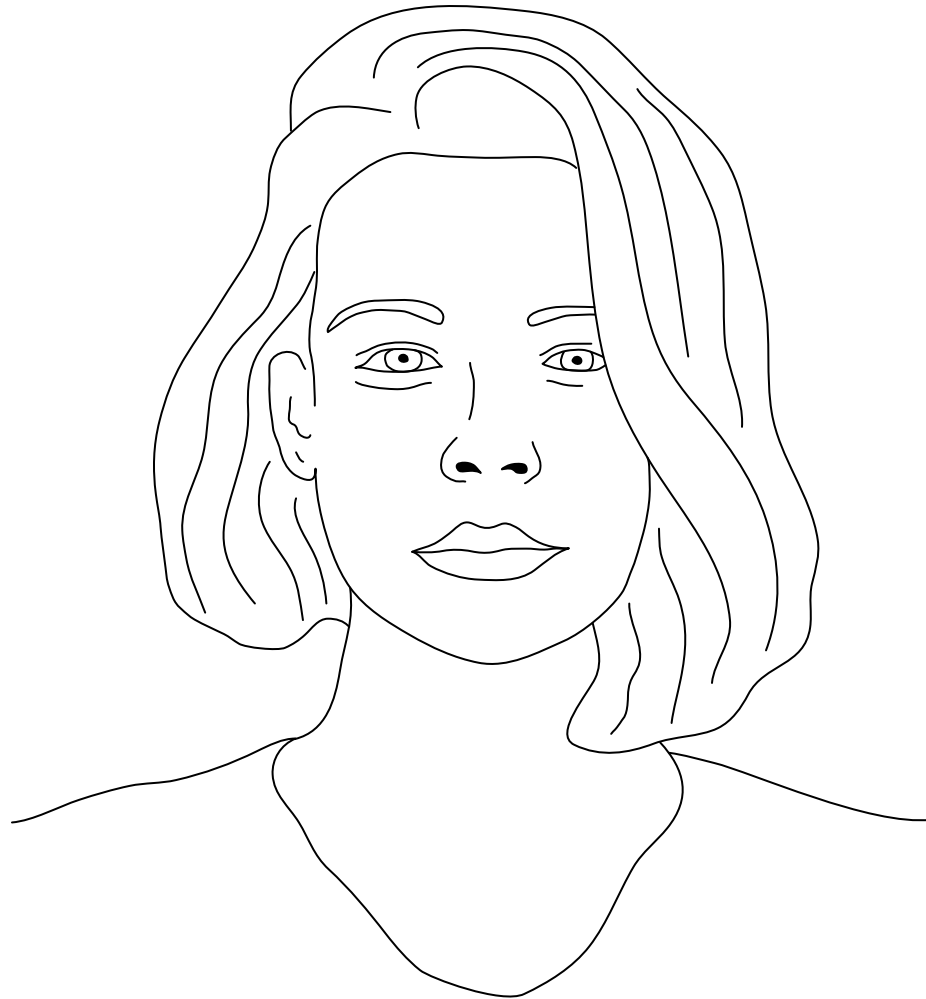

ITA Il mio sogno è lavorare nella moda... ma no, cosa avete capito, non voglio fare la modella e nemmeno la stilista. Mi piace il fashion marketing, studiare i trend del momento, individuare il target, ragionare in un'ottica social, creare un mood, analizzare il sentiment, insomma ci siamo capiti. È una passione che ho sempre avuto, fino da quando ero bambina e guardavo affascinata i trucchi e i vestiti della mamma... a proposito, stasera devo uscire, secondo voi che cosa mi metto?

ENG My dream is to work in fashion... but no, what do you understand, I don't want to be a model or even a stylist. I like fashion marketing, studying the trends of the moment, identifying the target audience, thinking in a social perspective, creating a mood, analysing sentiment, in short, you get the idea. It's a passion I've always had, ever since I was a child and I was fascinated by my mother's make-up and clothes... by the way, I'm going out tonight, what do you think I should wear?









Letto Kuma imbottito con testiera rivestita in ecopelle E207, giroletto 45° e piede Tondo.  
/Kuma upholstered bed with headboard in E207 eco-leather, 45° bed frame and Tondo leg.





Armadio Box con maniglia C39 attrezzato internamente di cassettera, ripiani e tubo appendiabiti.  
/Box wardrobe with C39 handle equipped with drawer pack, shelves and one hanger tube.











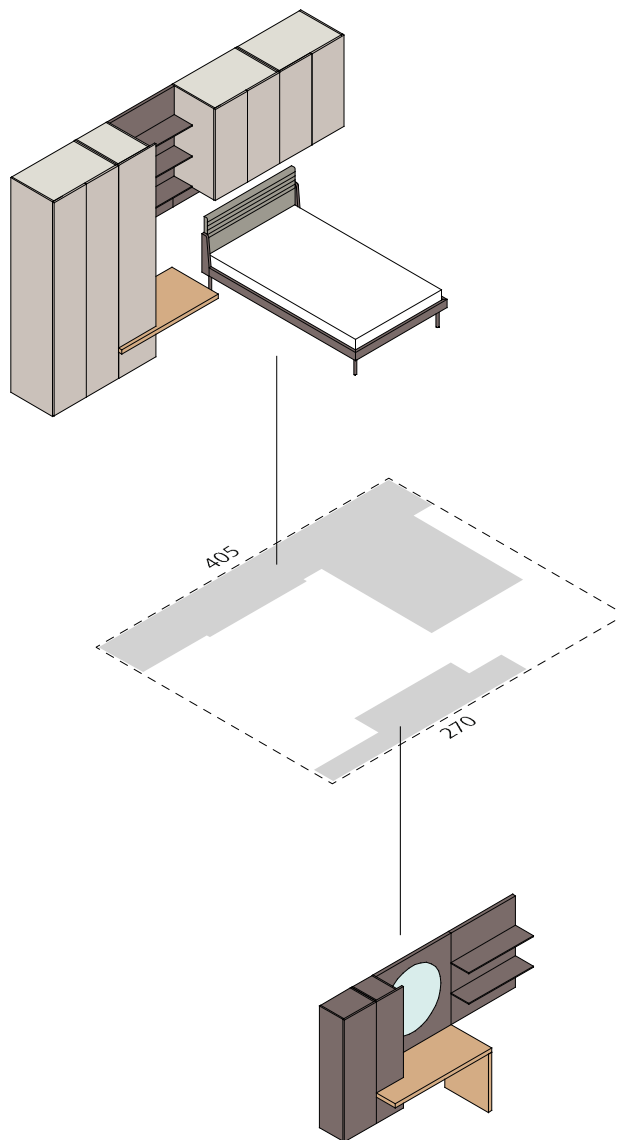

**Finiture / Finishes:**

- A - Melaminico Rovere / Rovere wood melamine
- B - Melaminico Tortora / Tortora melamine
- C - Laccato Argilla / Argilla lacquered finish
- D - Ecopelle E207 / E207 eco-leather



A



B



C



D

Ponti / Bridges

**Elementi / Elements:**

- 1 - Letto Kuma imbottito / Kuma upholstered bed
- 2 - Armadio Box / Box wardrobe
- 3 - Armadio Sipario / Sipario wardrobe
- 4 - Sistema Boiserie orizzontale / Horizontal Boiserie system
- 5 - Ponte Blok / Blok bridge
- 6 - Sistema Sipario / Sipario system
- 7 - Scrivania Sp.50mm / Th.50mm desk

S22\_P16

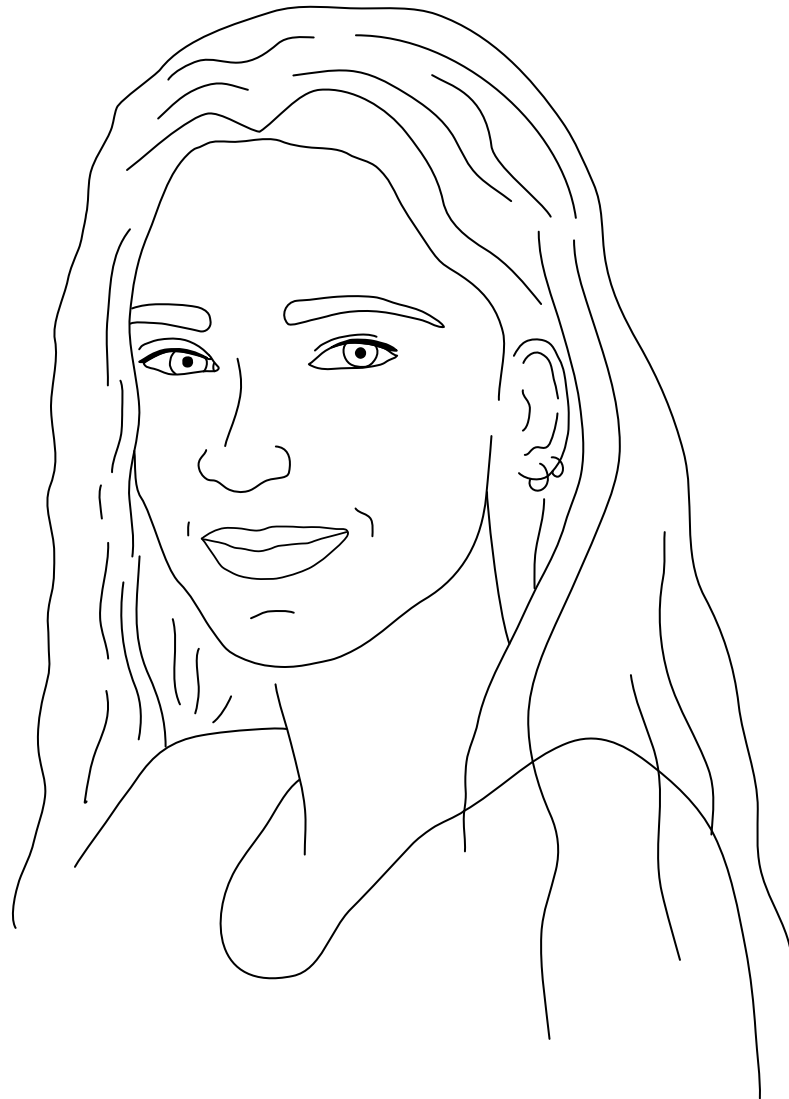

ITA Disco, tecno, new wave, elettronica tribale e anche un po' etnica, insomma c'è di tutto un po'. Sono ore che mi ascolto musica a palla con le cuffie e intanto penso al mio futuro. Accantonata l'idea di fare la giocatrice di basket professionista. Scartata la possibilità di diventare un'attrice, come sognavo quando andavo alle medie. E se invece seguissi veramente l'istinto e mi buttassi a fare la DJ? Ci penso ancora un po' su... mentre faccio la playlist del mio domani.

ENG Disco, techno, new wave, tribal and even a little ethnic electronic music, in short, everything. I've been listening to music for hours on my headphones and thinking about my future. The idea of becoming a professional basketball player has been shelved. Discarded the possibility of becoming an actress, as I dreamed of when I was in middle school. But what if I really follow my instincts and become a DJ? I'm still thinking about it... while I make my playlist for tomorrow.











Divano letto Apollo con rete da 1200mm con cassettoni estraibili./Apollo bed with 1200mm bed base and movable drawers.







Armadio Box con anta Slim Ghost, attrezzato con cassettera interna, Alveare, tubi appendiabiti e illuminazione. Armadio terminale con vano attrezzato di ripiano e tubi appendiabiti, vano a giorno con ripiani e appendini. / Box wardrobe with Slim Ghost doors, equipped with drawer pack, Alveare, hanger tubes and lighting. End module with shelf and hanger tubes, opened compartments with shelves and hangers.









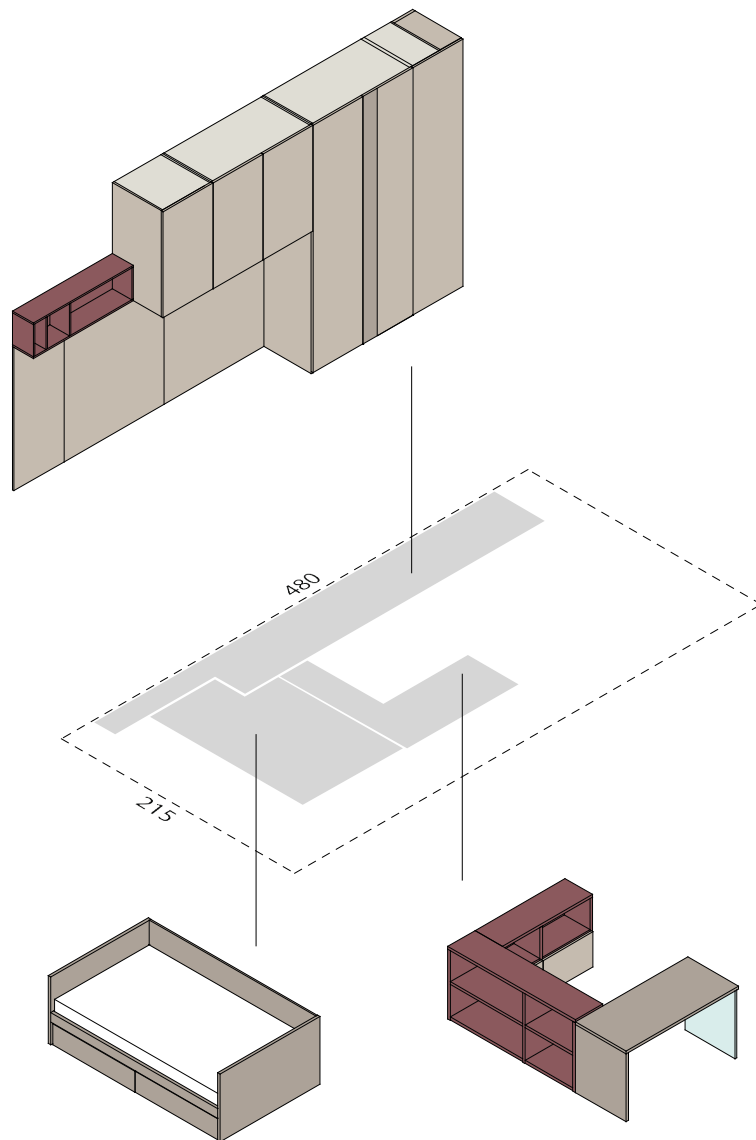

**Finiture / Finishes:**

- A - Dekor Avana
- B - Dekor Canapa
- C - Laccato Prugna / Prugna lacquered finish

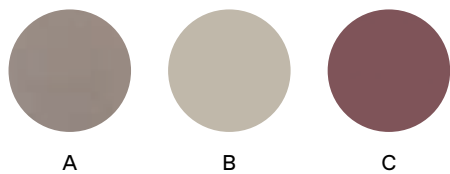

**Elementi / Elements:**

- 1 - Divano letto Apollo / Apollo bed
- 2 - Ponte Blok / Blok bridge
- 3 - Armadio Box / Box wardrobe
- 4 - Libreria a spalla bifacciale / Double sided library
- 5 - Scrivania con gamba in vetro / Desk with Glass leg
- 6 - Colonna Box terminale / Box end module

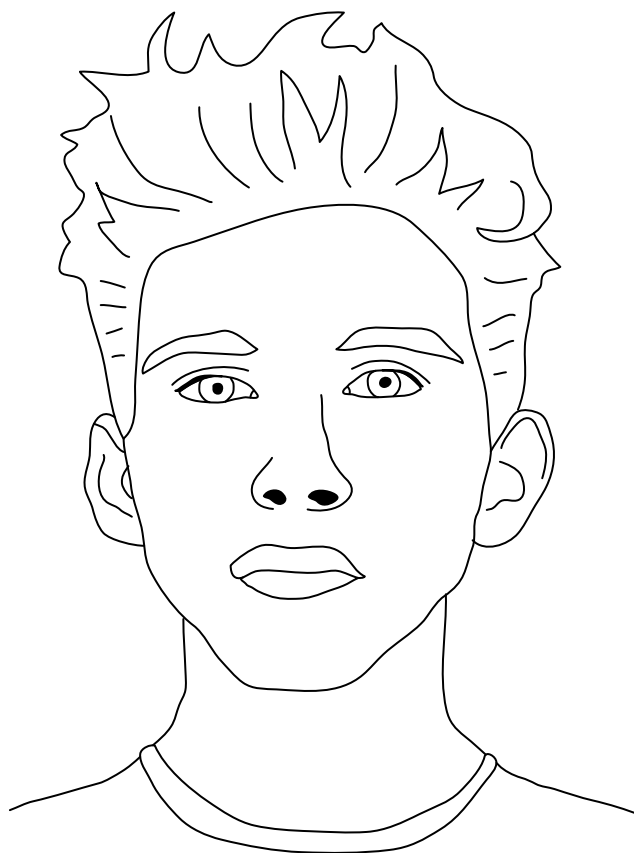

ITA Le vacanze sono iniziate e finalmente potrò dedicarmi al mio hobby preferito: aiutare il mio papà in garage. La passione per i motori è una cosa che abbiamo sempre avuto in comune: lui si è fatto una vera e propria officina in casa e così passiamo ore ed ore a trafficare, smontare, rimontare... ci piace un sacco sporcarci le mani, anche se quando torniamo su in casa, la mamma non è proprio contenta! Comunque è tutta esperienza preziosa, per quando a settembre inizierò ad andare all'istituto tecnico meccanico: non vedo l'ora.

ENG Holidays have started and I can finally dedicate myself to my favourite hobby: helping my dad in the garage. The passion for engines is something we have always had in common: he has made a real workshop at home and so we spend hours and hours trafficking, disassembling, reassembling ... we like a lot to get our hands dirty, even if when we go back home, Mom is not really happy! Anyway, it's all valuable experience, for when I start going to the technical mechanical institute in September: I can't wait.









Letto Karta con testiera imbottita in tessuto tessuto Redentore R035 e pianale raggiato con piede Slitta. / Karta bed with upholstered headboard in Redentore R035 fabric with flat bed and Slitta leg.









Cabina Maxi con anta Ghost 1200 attrezzata con cassettera interna, ripiani, tubi appendiabiti e illuminazione./Maxi wardrobe with Ghost 1200 door equipped with drawer pack, shelves, hanger tube and lighting.



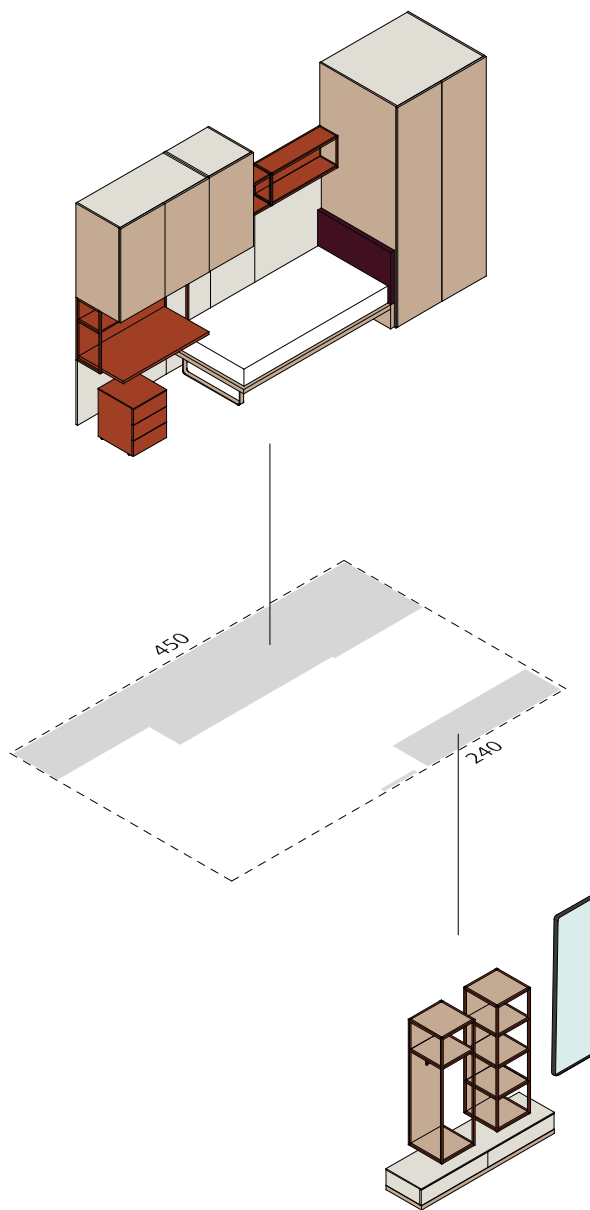

**Finiture / Finishes:**

- A - Melaminico Seta / Seta melamine
- B - Laccato Caramello / Caramello lacquered finish
- C - Laccato Fulvo / Fulvo lacquered finish
- D - Tessuto Redentore R035 / Redentore R035 fabric

**Elementi / Elements:**

- 1 - Letto Karta / Karta bed
- 2 - Cabina Maxi / Maxi wardrobe
- 3 - Ponte Blok / Blok bridge
- 4 - Scrivania sospesa Kios / Kios suspended desk

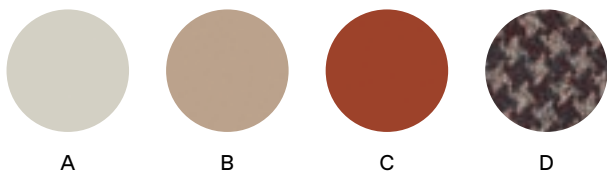



ITA Vediamo cosa c'è domani a scuola... due ore di italiano, l'amor cortese, la poesia provenzale, ok mi piace. Un'ora di matematica, equazioni e disequazioni irrazionali, mi piace un po' meno. Un'ora di storia, le scoperte geografiche: fantastico. Oh no, ultima ora educazione fisica! Non so proprio cosa farci, ma lo sport non è proprio la mia passione. Sono un contemplativo, starei piuttosto ore ed ore in camera a leggere e sognare. Quasi quasi, l'ultima ora dico che ho mal di testa, così ripasso un po' di filosofia... e magari faccio due chiacchiere con quella biondina che mi piace tantissimo!

ENG Let's see what's on in school tomorrow... two hours of Italian, courtly love, Provençal poetry, I like it. One hour of mathematics, irrational equations and inequalities, I like it a little less. One hour of history, geographical discoveries: fantastic. Oh no, last hour PE! I don't really know what to do with it, but sport isn't really my thing. I'm a contemplative, I'd rather spend hours and hours in my room reading and dreaming. I'll just say I have a headache in the last hour and I'll go over some philosophy... and maybe have a chat with that blonde I really like!













Testiera sospesa Kios in tessuto Marmolada M006 con giroletto 45° con piede Quadra.  
/Suspended headboard Kios in Marmolada M006 fabric with 45° bed frame and Quadra leg.







Basi a terra con cassettoni e maniglia C38 . Scrivitoio sospeso Kios attrezzato di barra Multisystem con prese USB, Schuko e faretto / Base units with drawers and C38 handle. Suspended desk Kios equipped with Multisystem bar with USB and Schuko socket and lighting.





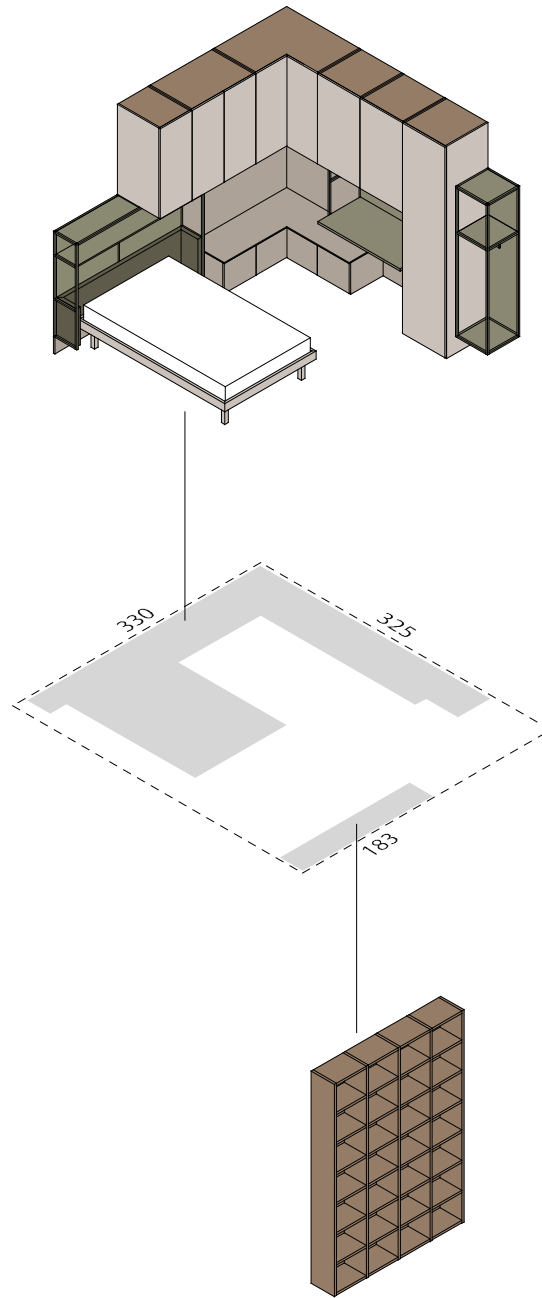

**Finiture / Finishes:**

- A - Melaminico Noce / Noce wood melamine
- B - Melaminico Tortora / Tortora melamine
- C - Dekor Avana
- D - Laccato Oliva / Oliva lacquered finish
- E - Tessuto Marmolada M006 / Marmolada M006 fabric

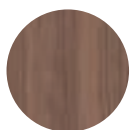

A



B



C



D



E

Ponti / Bridges

**Elementi / Elements:**

- 1 - Testiera sospesa Kios / Kios suspended headboard
- 2 - Scrivania sospesa Kios / Kios suspended desk
- 3 - Basi a terra / Base units
- 4 - Ponte a terra / Classic bridge
- 5 - Armadio Box / Box wardrobe
- 6 - Cabina sospesa Kios / Kios closet
- 7 - Libreria Spalla / Spalla library

S22\_P19

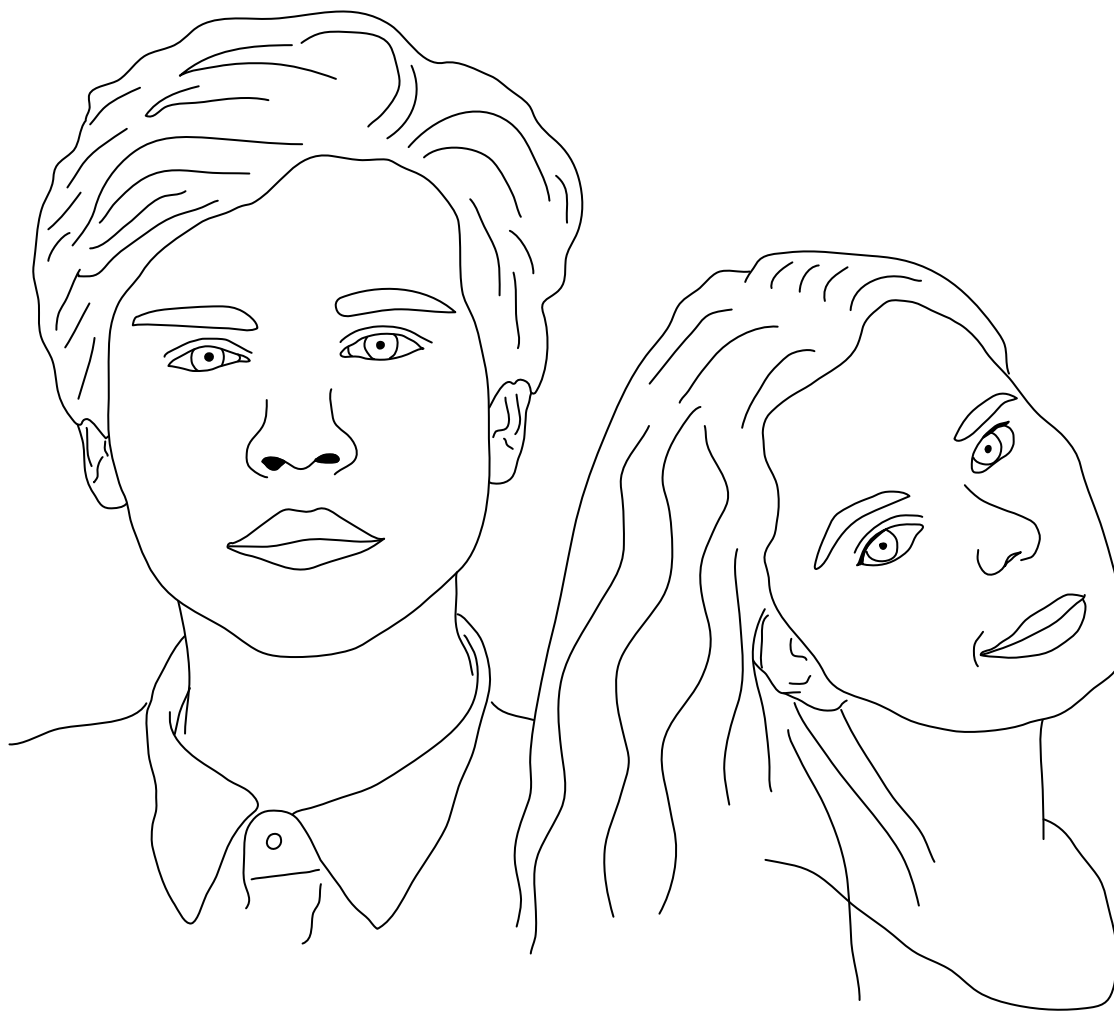

ITA Io sono appassionato di tiro con l'arco, fino da piccolo: il mio sogno è partecipare alle Olimpiadi. Lei è venuta solo una volta al campo a provare e ha detto: che noia! Invece è maniaca dell'equitazione, non fa che parlare di cavalli e dice che quando sarà diventata brava, andrà a fare le gare. Io da quest'anno vado al liceo scientifico perchè adoro la matematica, lei dice che dopo le medie si iscriverà al liceo classico perchè adora l'italiano. Però ci vogliamo bene lo stesso: siamo diversi, ma complementari.

ENG I've been an archery enthusiast since I was a child: my dream is to take part in the Olympics. She's only come to the camp once to try out and said: what a bore! But she's crazy about horse riding, all she does is talk about horses and says that when she gets good at it she'll go and compete. This year I'm going to the scientific high school because I love maths, she says that after middle school she'll enrol in the classical high school because she loves Italian. But we love each other anyway: we're different, but complementary.











Cabina Palko attrezzata di ripiani con appendiabiti, ripiani porta scarpe e basi a terra con cassetti.  
/Palko walk-in closet equipped with shelves with hangers, shelves for shoes and ground units with drawers.







Letto Lobby Basso con letto Lobby Estrabile e cassettoni.  
/Lobby Basso bed with Lobby Estrabile bed and drawers.



Zona studio con scrittoio in sp.50mm, sistema boiserie orizzontale con mensole, barra Multysistem con illuminazione e prese elettriche./Study area consisting of th.50mm desk, horizontal boiserie system with shelves, Multysistem bar with lighting and sockets.







Armadi Box con ante battenti, attrezzati internamente di ripiani e tubi appendiabiti.  
/Box wardrobes with hinged doors, equipped with shelves and hanger tubes.





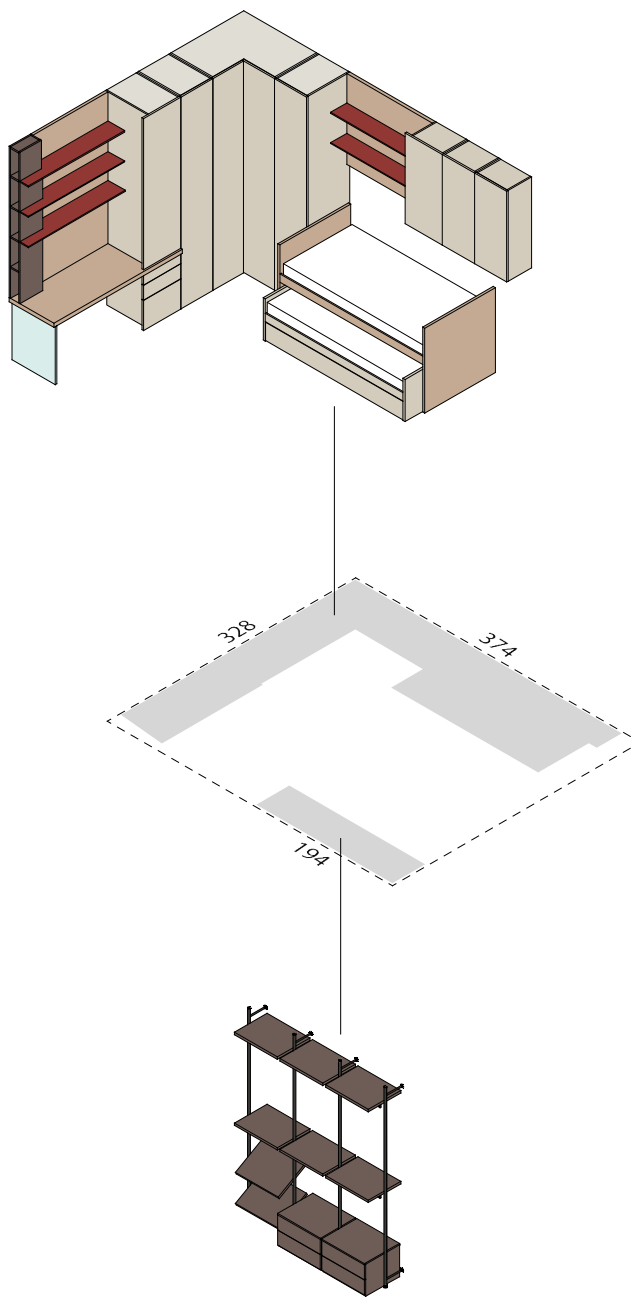

**Finiture / Finishes:**

- A - Melaminico Beige / Beige melamine
- B - Dekor Bronzo
- C - Melaminico Pepper / Pepper melamine
- D - Laccato Caramello / Caramello lacquer finish

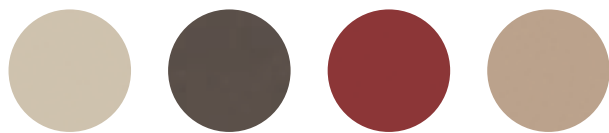

A

B

C

D

**Elementi / Elements:**

- 1 - Letti Lobby / Lobby beds
- 2 - Armadi Box / Box wardrobes
- 3 - Scrivania Sp.50mm / Th.50mm desk
- 4 - Sistema Boiserie Orizzontale / Horizontal Boiserie system
- 5 - Pensili / Wall units
- 6 - Cabina Palko / Palko walk-in closet



ITA Quando arriva la sera, mia sorella mi chiede sempre di raccontarle una storia. Allora mi invento una fiaba: c'era una volta una bambina che voleva diventare una ballerina, ma purtroppo non era molto brava. Per quanto studiassi e si impegnasse alla scuola di danza, non faceva progressi. Le compagne la prendevano in giro, la maestra si arrabbiava. Una notte le apparve una fatina e le portò delle scarpette magiche... ma il finale della storia non arriva mai, perché lei si è già addormentata.

ENG When evening comes, my sister always asks me to tell her a story. So I make up a fairytale: once upon a time there was a little girl who wanted to be a dancer, but unfortunately she wasn't very good at it. No matter how hard she studied and worked at the dance school, she didn't make any progress. Her classmates made fun of her and her teacher got angry. One night a fairy appeared and brought her some magic shoes... but the end of the story never came, because she had already fallen asleep.











Letto Lobby Corner con cassetti e meccanismo per alzata letto con contenitore, letto Lobby con rete estraibile./Lobby Corner bed with drawers and bed base lift-up mechanism, Lobby bed with second movable bed base.





Armadio Box Corner con maniglia Stripe attrezzato con ripiani, tubi appendiabiti e illuminazione.  
/Box corner wardrobe with Stripe handle equipped with shelves, hanger tubes and lighting.





Scrivani sospesi sp.50mm con casellari Gate e cassettiere su ruote./Suspended desks th.50mm with Gate wall units and drawers on wheels.







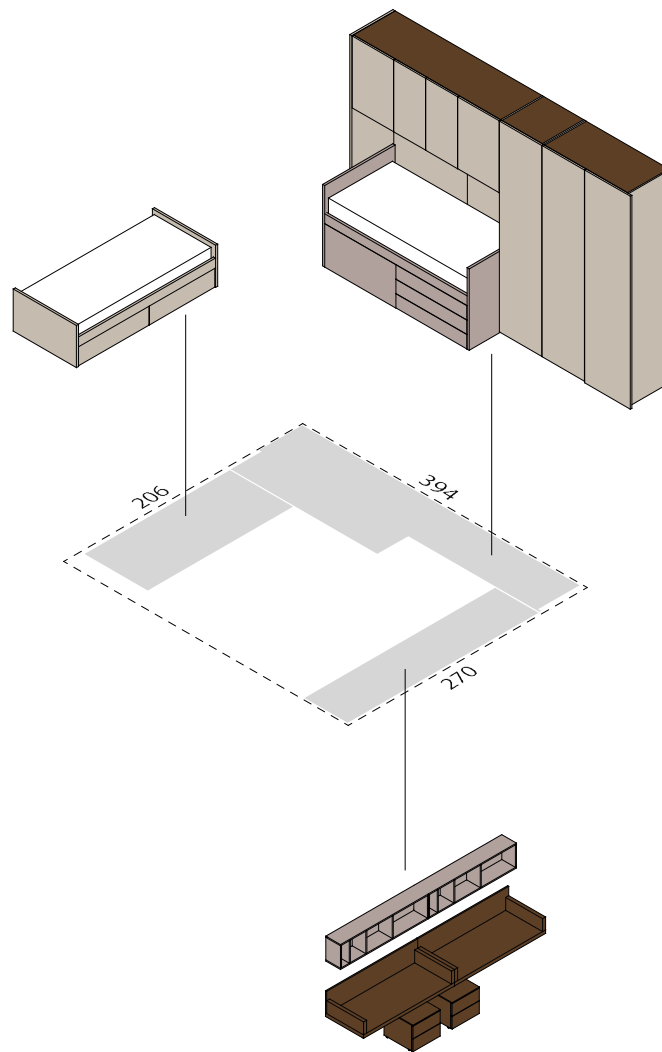

**Finiture / Finishes:**

- A - Melaminico Seta / Seta melamine
- B - Dekor Canapa
- C - Laccato Ortensia / Ortensia lacquered finish
- D - Melaminico Cotto / Cotto wood melamine



A



B



C



D

Ponti / Bridges

**Elementi / Elements:**

- 1 - Letto Lobby Corner / Lobby Corner bed
- 2 - Letto Lobby estraibile / Lobby movable bed
- 3 - Armadi Box / Box wardrobe
- 4 - Scrivania sospesi / Suspended desks
- 5 - Casellari Gate / Gate wall units

S22\_P21



ITA Non ho ancora deciso se da grande voglio fare la fotografa, oppure la poliziotta. A pensarci bene, tutte e due queste professioni hanno dei vantaggi. Se divento una fotografa, sarò sempre in giro per fare servizi di moda, di sport, sulla natura e quindi non dovrò restare con quella peste mio fratello. Se invece divento poliziotta, potrò finalmente metterlo in prigione, quando lo becco di nuovo a curiosare fra le mie cose. Sto scherzando, è un diavolelto vivace, ma lo sono anche io!

ENG I still haven't decided whether I want to be a photographer or a policewoman when I grow up. Come to think of it, both professions have advantages. If I become a photographer, I will always be around to do fashion, sports and nature shoots, so I won't have to stay with my sick brother. If I become a policewoman, I can finally put him in prison when I catch him going through my things again. I'm joking, he's a lively little devil, but so am I!











Letto Lobby medio e letto Lobby estraibile con seconda rete.  
/Lobby middle bed and Lobby movable bed with second bed base.

Armadio Box attrezzato con cassettera interna, ripiani e tubi appendiabiti. Cabina Kios con ripiano e tubo appendiabiti./Box wardrobe equipped with drawer pack, shelves and tube hanger. Kios closet with shelf and hanger tube.







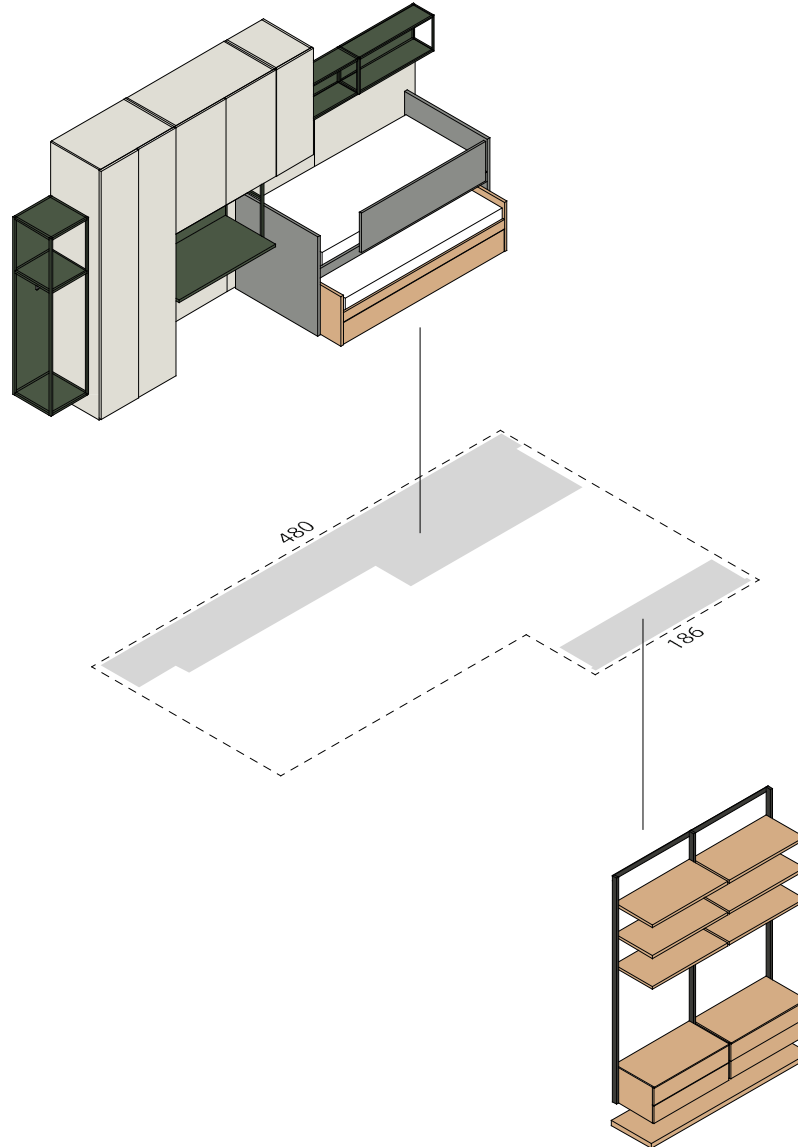

**Finiture / Finishes:**

- A - Melaminico Rovere / Rovere wood melamine
- B - Melaminico Seta / Seta melamine
- C - Laccato Piombo / Piombo lacquered finish
- D - Laccato Pino / Pino lacquered finish



A



B



C



D

Ponti / Bridges

**Elementi / Elements:**

- 1 - Letto Lobby / Lobby bed
- 2 - Letto Lobby Estraibile / Lobby Estraibile bed
- 3 - Armadio Box / Box wardrobe
- 4 - Ponte Blok / Blok bridge
- 5 - Scrivania Kios / Kios desk
- 6 - Cabina Naked / Naked walk-in closet

S22\_P22

ITA Un ambiente da vivere e da condividere, capace di dare spazio ai desideri e alle necessità di ognuno, senza rinunciare alla privacy, al comfort e nemmeno allo stile. Letti doppi oppure a castello che riuniscono diversi piani e funzioni, creando una dimensione ottimale. Soluzioni per il guardaroba e il contenimento che risolvono ogni piccola e grande esigenza. Postazioni organizzate e accoglienti per studiare, in piacevole armonia con il corpo, la mente e gli elementi dell'arredo. Colori che accendono la fantasia dei bambini, oppure rispecchiano la personalità degli adolescenti: un mondo pieno di idee e di vita.

ENG An environment to live and share, capable of giving space to everyone's desires and needs, without sacrificing privacy, comfort or even style. Single or bunk beds that combine several floors and functions, creating an optimal dimension. Wardrobe and storage solutions that solve every need large and small. Organised and cosy places to study, in pleasant harmony with body, mind and furniture elements. Colours that spark the imagination of children, or reflect the personality of teenagers: a world full of ideas and life.





ITA Ci chiamano Eden e Thorgan, come i fratelli Hazard: tutti e due attaccanti, io più trequartista. Abbiamo una grande passione per il calcio, ma ognuno di noi ha la sua personalità e i suoi obiettivi. Lui ha due anni più di me e va all'istituto tecnico per geometri, ha già le idee chiare sul suo futuro. Io forse perché vado ancora alle medie, sono un po' indeciso, anche se il mio sogno è fare il medico. Nel frattempo ci diamo dentro con lo sport e anche con la musica: è un'altra passione che abbiamo in comune.

ENG We're called Eden and Thorgan, like the Hazard brothers: both of us are strikers, I'm more of an attacking midfielder. We have a great passion for football, but we each have our own personalities and goals. He's two years older than me and goes to the technical institute for surveyors, he already has clear ideas about his future. Perhaps because I'm still in secondary school, I'm a bit undecided, although my dream is to be a doctor. In the meantime, we get on with sport and music: it's another passion we have in common.











Letto Sky con salita posteriore, protezione Dama in tessuto, letto Puzzle con giroletto 45° e piede Quadra./Sky bunk bed with rear access, upholstered protections Dama, Puzzle bed with 45° bed frame and Quadra leg.









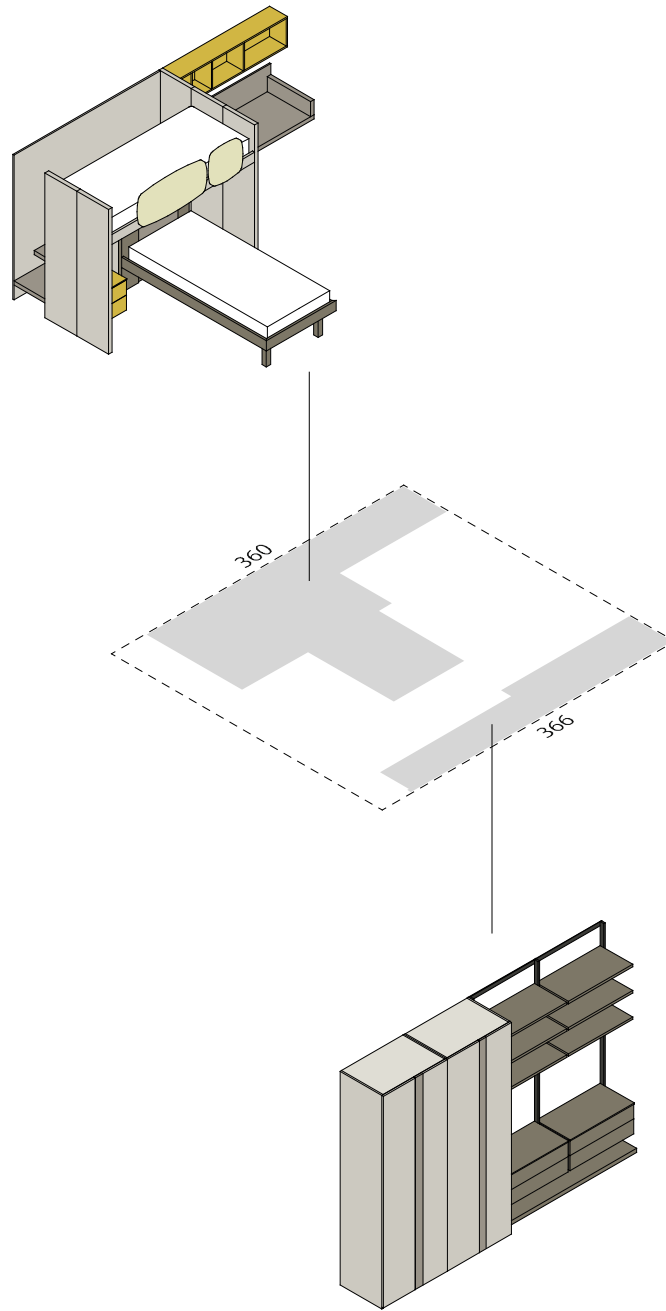

**Finiture / Finishes:**

- A - Melaminico Ossidato / Ossidato wood melamine
- B - Laccato Perla / Perla lacquered finish
- C - Laccato Titanio / Titanio lacquered finish
- D - Laccato Miele / Miele lacquered finish
- E - Tessuto Bono TB28 / Bono TB28 fabric



A



B



C



D



E

**Elementi / Elements:**

- 1 - Letto Sky / Sky bunk bed
- 2 - Letto Puzzle / Puzzle bed
- 3 - Armadio spalla Slim Ghost / Slim Ghost shoulder wardrobe
- 4 - Cabina Naked / Naked walk-in closet
- 5 - Scrivania sospesa / Suspended desk
- 6 - Casellario Gate / Gate wall unit



ITA Caro diario, ieri ho litigato un'altra volta con mio fratello. Lui è tornato dalla partita di rugby tutto esaltato perché avevano vinto e si è messo a fare confusione. Smettila, gli ho detto, devo fare i compiti! E lui per farmi dispetto, faceva ancora più rumore. Così ci siamo messi a fare la lotta. Ovviamente stava vincendo lui, ma per fortuna la mamma ci ha separati. Dopo, come sempre, abbiamo fatto la pace e lui ha promesso che mi insegnerà a giocare a scacchi.

ENG Dear diary, yesterday I had another fight with my brother. He came back from the rugby match all excited because they'd won and started making a fuss. Stop it, I said, I have homework to do! And to spite me, he made even more noise. So we got into a fight. Of course he was winning, but luckily mum separated us. Afterwards, as always, we made up and he promised to teach me how to play chess.











Letto Sky con scaletta frontale in metallo, scrittoio con gamba Slim.  
/Sky bunk bed with frontal metal ladder, desk with Slim leg.









Cabina armadio Maxi attrezzata internamente di ripiani, tubi appendiabiti e illuminazione. Armadio terminale con vano a ripiani e vano a giorno con appendiabiti e specchio./Maxi walk-in closet equipped with shelves, hanger tubes and lighting. End module with shelves compartment and opened compartment with hangers and mirror.





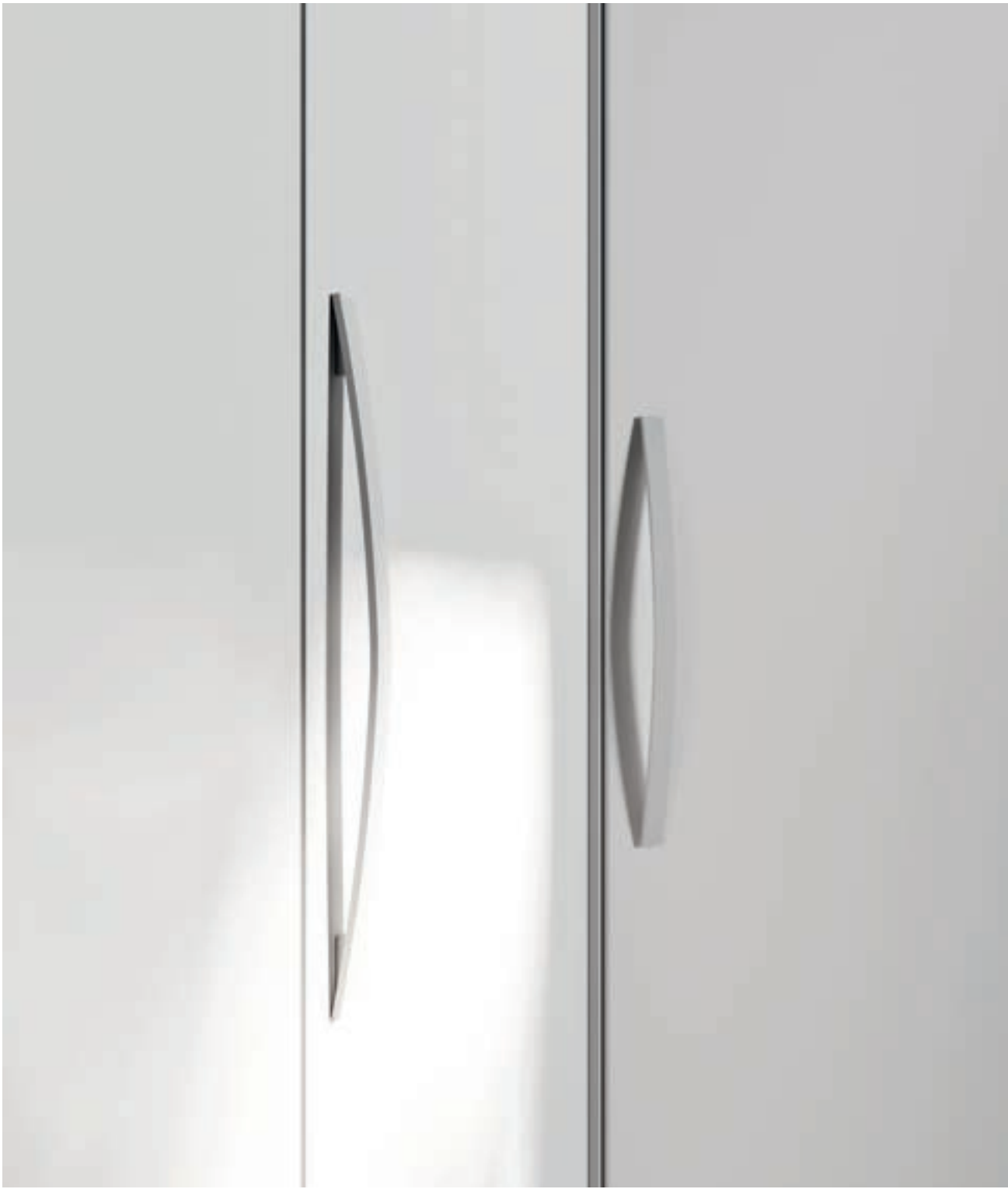

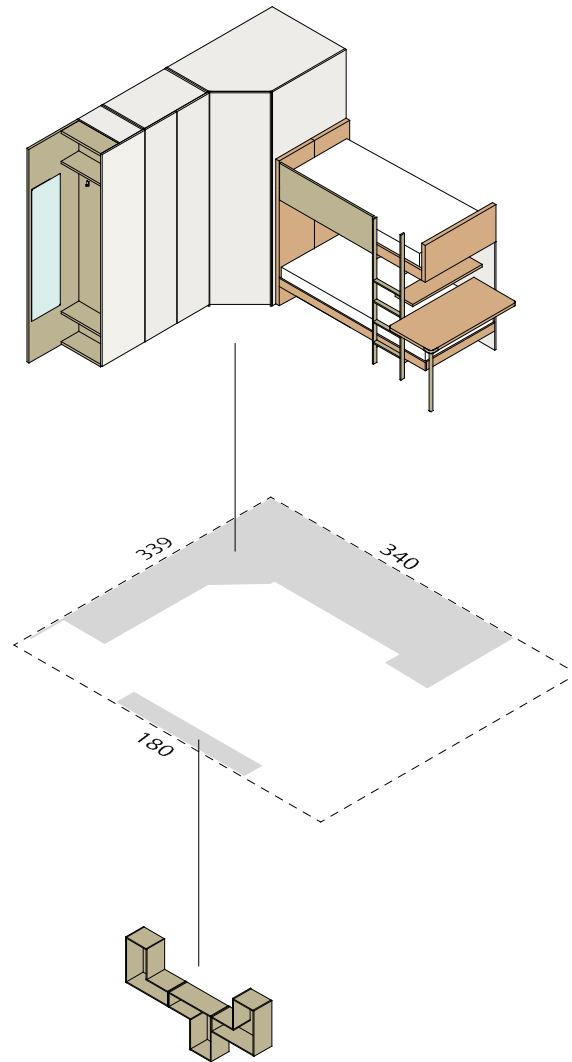

**Finiture/Finishes:**

- A - Melaminico Rovere / Rovere wood melamine
- B - Melaminico Bianco / Bianco melamine
- C - Laccato Malva / Malva lacquered finish

**Elementi/Elements:**

- 1 - Letto Sky / Sky bunk bed
- 2 - Cabina Maxi / Maxi walk-in closet
- 3 - Armadio Box / Box wardrobe
- 4 - Casellari Trigo / Trigo wall unit



A

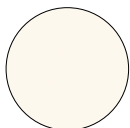

B



C



ITA Oggi non vado ad atletica, ho il raffreddore e perciò resto tappata in camera a studiare. Per giovedì devo fare una ricerca di scienze e anche se all'inizio mi annoiavo un po', l'argomento inizia ad appassionarmi. Gli dei dell'Olimpo erano proprio... mitici! Ho trovato un bel libro di mio fratello sull'argomento e in più, sto cercando su Google altre informazioni. Però devo fare in fretta, non vorrei che quando ritorna da nuoto si accorgesse che glielo ho preso: è gelosissimo delle sue cose.

ENG Today I am not going to athletics, I have a cold and therefore I am staying in my room to study. By Thursday I have to do a science paper and although I was a bit bored at first, the subject is starting to fascinate me. The gods of Olympus were really... mythical! I found a nice book by my brother on the subject and I'm also googling for more information. But I have to be quick, I don't want him to notice when he comes back from swimming that I took it from him: he's so jealous of his stuff.









Scrittoio Isola con cassetto./Isola desk with drawer.







Letto Cale con testiera in tessuto Demetra D005, giroletto 45° con piede Elle in finitura meallizzata Cumino./Cale bed with upholstered headboard in Demetra D005 fabric, 45° bed frame with Elle leg in Cumino metallic finish.





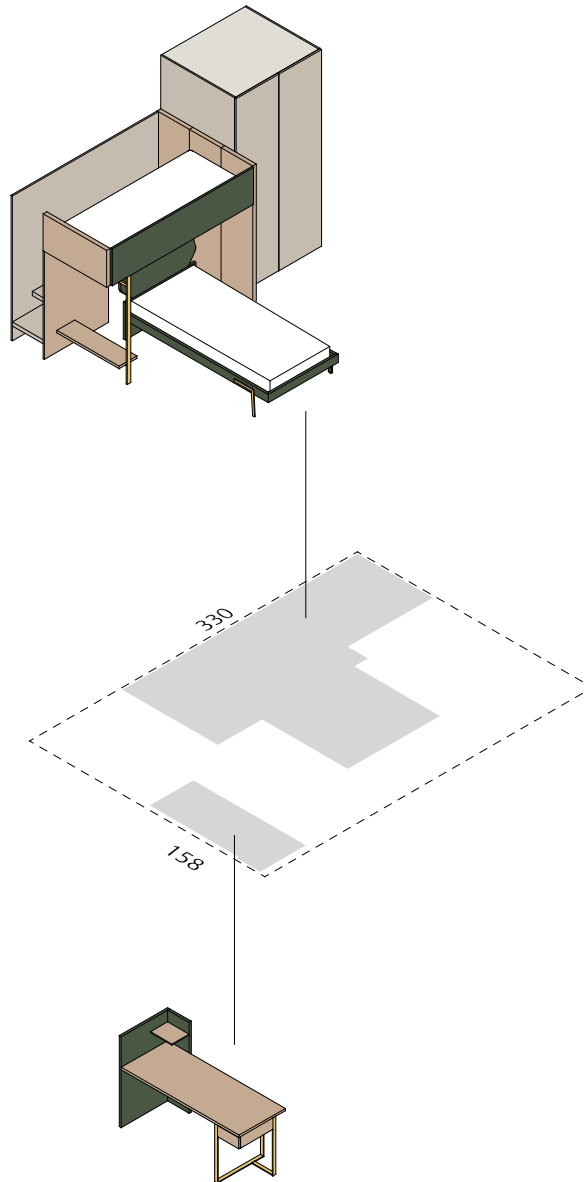

**Finiture / Finishes:**

- A - Dekor Canapa
- B - Laccato Caramello / Caramello lacquered finish
- C - Laccato Pino / Pino lacquered finish
- D - Tessuto Demetra D005 / Demetra D005 fabric
- E - Laccato metallizzato Cumino / Cumino metallized lacquered finish



A



B



C

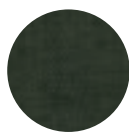

D



E

**Elementi / Elements:**

- 1 - Letto Sky / Sky bunk bed
- 2 - Letto Cale / Cale bed
- 3 - Cabina Maxi / Maxi walk-in closet
- 4 - Scrivania Sipario / Sipario desk



ITA Il nostro gioco preferito è trasformare la nostra cameretta in un laboratorio. Io studio l'antico Egitto, disegno geroglifici, mummie e piramidi sul mio quaderno di appunti. Mia sorella invece fa strani esperimenti, seguendo le istruzioni su Youtube. Sembriamo proprio due scienziate... oppure due streghe! È passato quasi un intero pomeriggio e non ce ne siamo nemmeno accorte. Peccato che sia già ora di andare a cena: ma domani, quando ritorniamo da scuola, riprenderemo i nostri studi segreti.

ENG Our favourite game is to turn our bedroom into a laboratory. I study ancient Egypt, drawing hieroglyphics, mummies and pyramids in my notebook. My sister, on the other hand, does strange experiments, following instructions on YouTube. We look like two scientists... or two witches! It's been almost a whole afternoon and we haven't even noticed. It's a pity it's already time for dinner, but tomorrow, when we get back from school, we'll resume our secret studies.













Letto Slide con salita posteriore, protezione Gate reclinabile in metallo, letto inferiore estraibile con cassettoni./Slide bunk bed with rear access, reclining metal protection Gate, pull-out lower bed with drawers.



Armadio scorrevole Slim attrezzato con ripiani, tubi appendiabiti e cassettera interna.  
/Slim sliding door wardrobe equipped with shelves, hanger tubes and drawer pack.





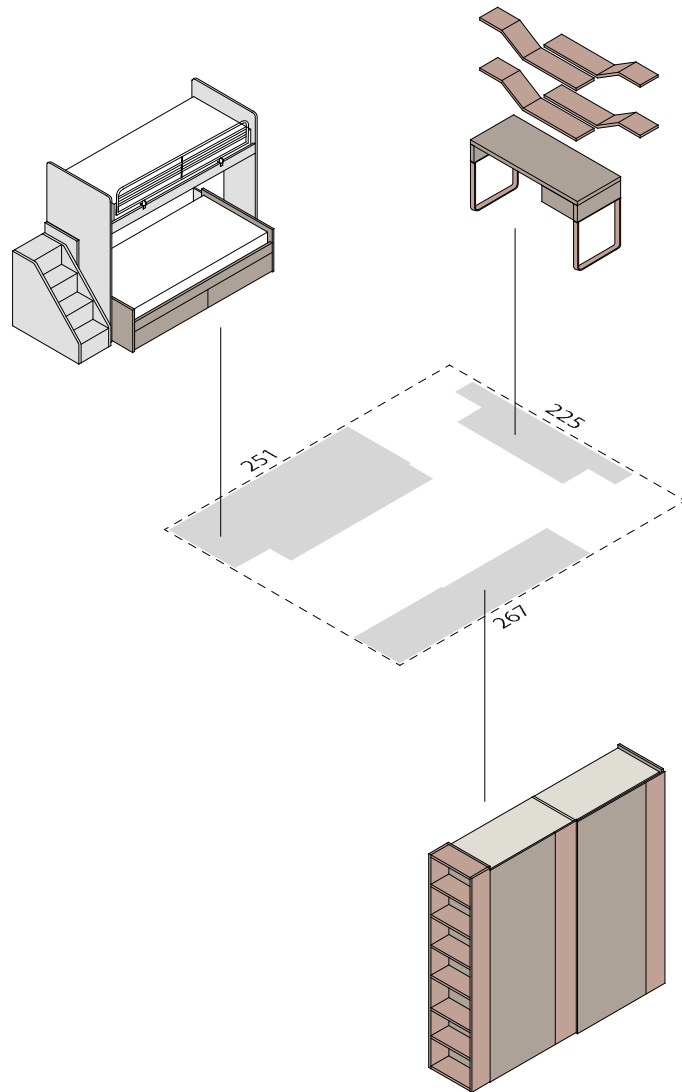

**Finiture / Finishes:**

- A - Melaminico Sbiancato / Sbiancato wood melamine
- B - Dekor Avana
- C - Melaminico Dalia / Dalia melamine



A



B

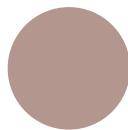

C

**Elementi / Elements:**

- 1 - Letto Slide / Slide bunk bed
- 2 - Letto estraibile / Pull-out bed
- 3 - Armadio scorrevole Slim / Slim sliding door wardrobe
- 4 - Scrivania Slitta / Slitta desk
- 5 - Mensole Star / Star shelves

MANIGLIE/HANDLES → P.322

FINITURE E TESSUTI/FINISHES AND TEXTILES → P.326





C24 - L 180 mm



C03 - L 340 mm



C01 - D 20 mm



C09 - L 138 mm



C26 - L 80 mm



C17 - L 205 mm



C40 - L 400 mm



C41 - L 660 mm



C36 - L 170 mm



C37 - L 330 mm



C25 - L 180 mm



C07 - L 340 mm



C28 - L 220 mm



C21 - L 570 mm



C38 - L 40 mm



C39 - L 230 mm



C29 - L 220 mm



C15 - L 1200 mm



C42 - L 1010 mm





Melaminici struttura / Structure melamine

---

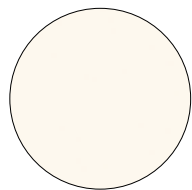

Bianco

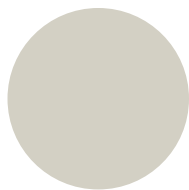

Seta



Sbiancato



Ossidato



Cotto



Rovere



Noce

Melaminici neutri / Neutral Melamine

---



Beige

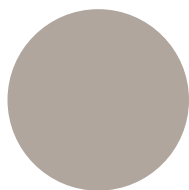

Tortora

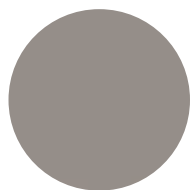

Platino

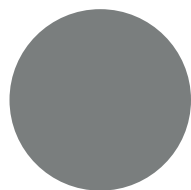

Grigio

Melaminici colorati / Coloured Melamine

---

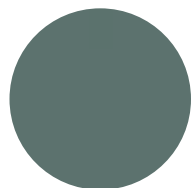

Petrolio

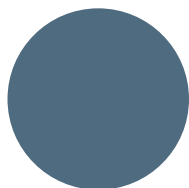

Cobalto

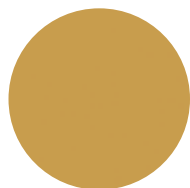

Curcuma

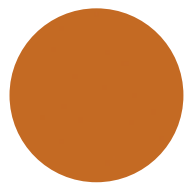

Paprika

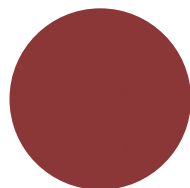

Pepper

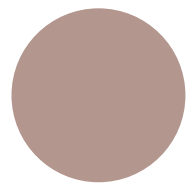

Dalia

Dekor

---

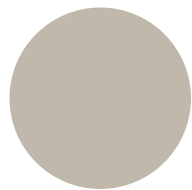

Canapa



Avana



Bronzo

Finitura struttura per armadio spalla / Finishes for supporting side wardrobe

---



Seta

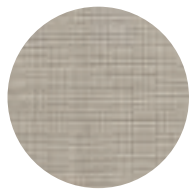

Greyge

Vetri / Glasses

---



Vetro bronzato

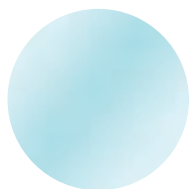

Vetro trasparente

Laccati/Lacquered finishes

---

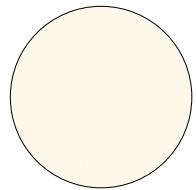

Calce

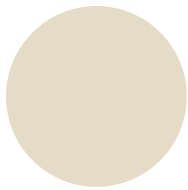

Sahara

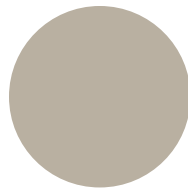

Sabbia

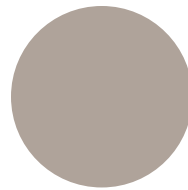

Ecrù

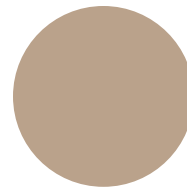

Caramello

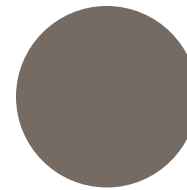

Terra

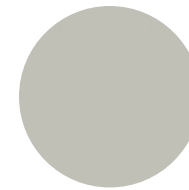

Perla

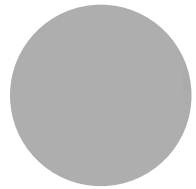

Piuma

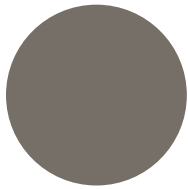

Titanio

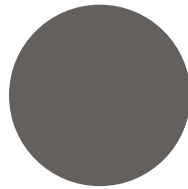

Antracite

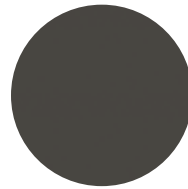

Tufo

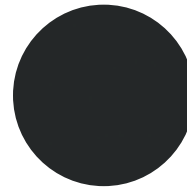

Nero

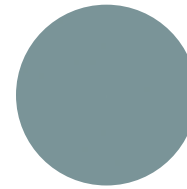

Avio

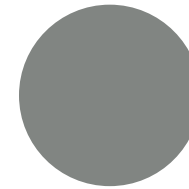

Piombo

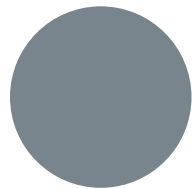

Nebbia

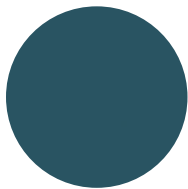

Indaco

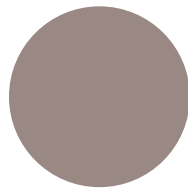

Ortensia

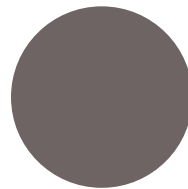

Argilla

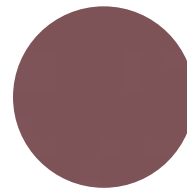

Prugna

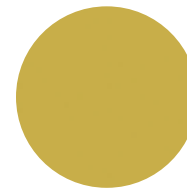

Miele

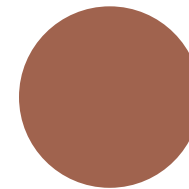

Cannella

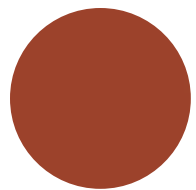

Fulvo

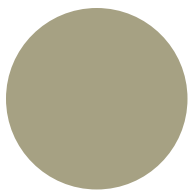

Malva

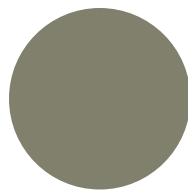

Oliva

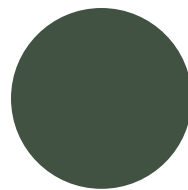

Pino

Laccati metallizzati/Metallized lacquered finishes

---

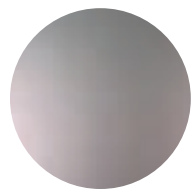

Argento

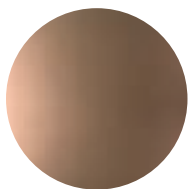

Cumino

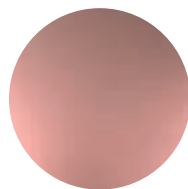

Copper

Laccati linea/Linea lacquered finish

---

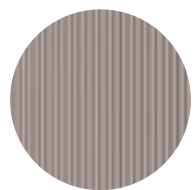

Tessuto Demetra / Demetra Fabric

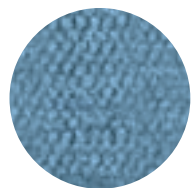

D003

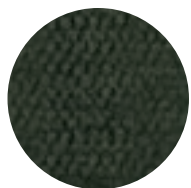

D005

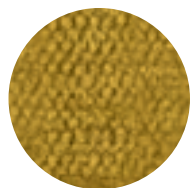

D09

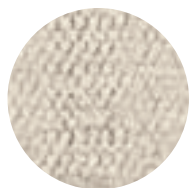

D020

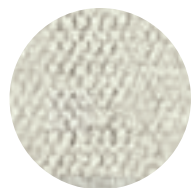

D021

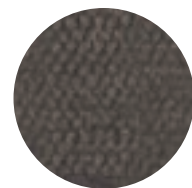

D022



D023

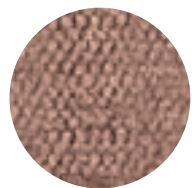

D024

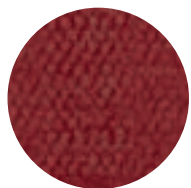

D026

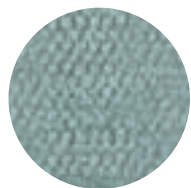

D027

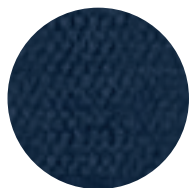

D029

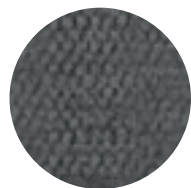

D031



D032

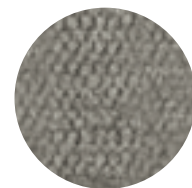

D033

Tessuto Kora / Kora Fabric



K001

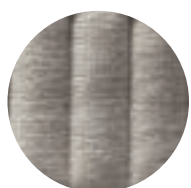

K002



K003

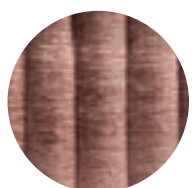

K004

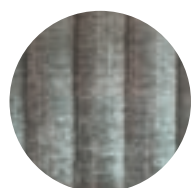

K005

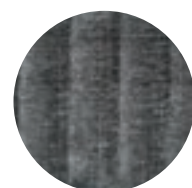

K006

Tessuto Mumble / Mumble Fabric

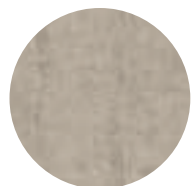

M011



M012

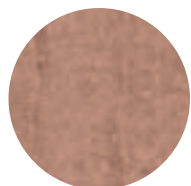

M013

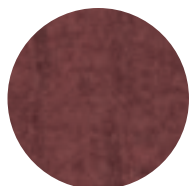

M014



M015



M016



M017

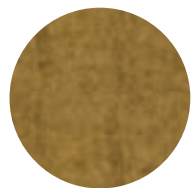

M018



M019

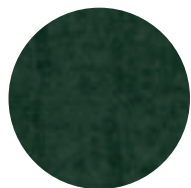

M020

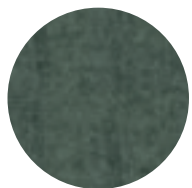

M021



M022



M023



M024

Tessuto Malvasia / Malvasia Fabric

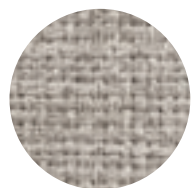

TB11

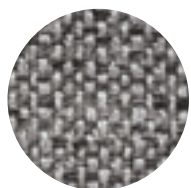

TB12



TB13

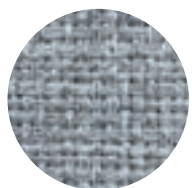

TB14



TB15



Tessuto Sarin/Sarin Fabric

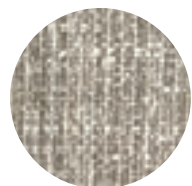

S301

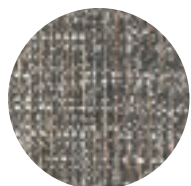

S302



S303

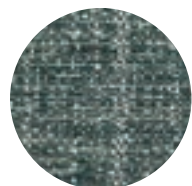

S304

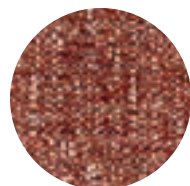

S305

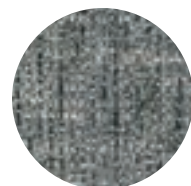

S306

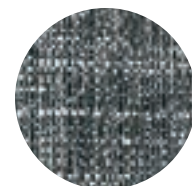

S307



S308

Tessuto Bono/Bono Fabric

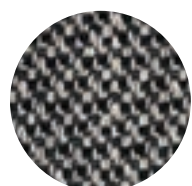

TB20

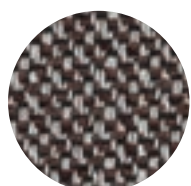

TB21

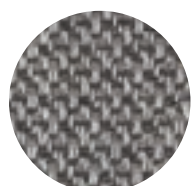

TB22

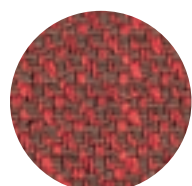

TB23

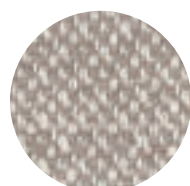

TB24

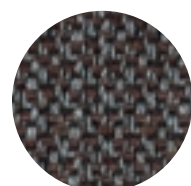

TB25

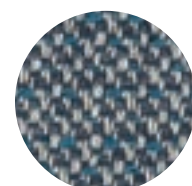

TB26

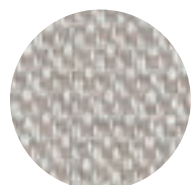

TB27

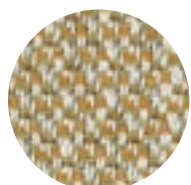

TB28



TB29

Tessuto Elba/Elba Fabric

Rivestimenti testiere, Pannelli imbottiti, Pouf e Sedie



TB30



TB31



TB32

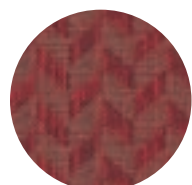

TB33



TB34

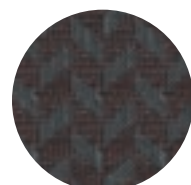

TB35

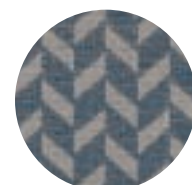

TB36

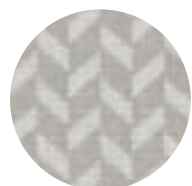

TB37



TB38



TB39

Tessuto Murano/Murano Fabric

---



M031



M032



M033

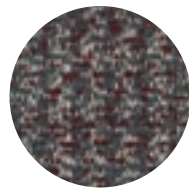

M034

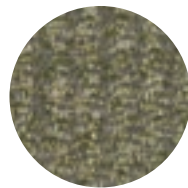

M035

Tessuto Redentore/Redentore Fabric

---

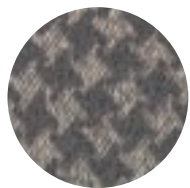

R031

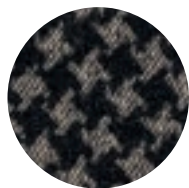

R032



R033

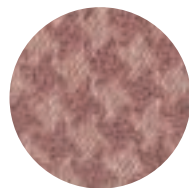

R034

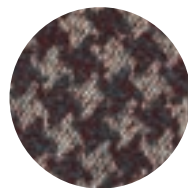

R035

Tessuto Marmolada/Marmolada Fabric

---

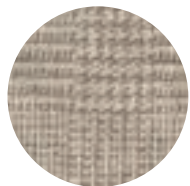

M001

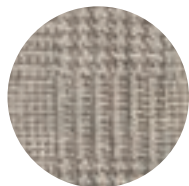

M002

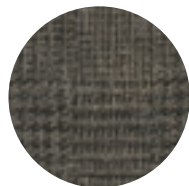

M003

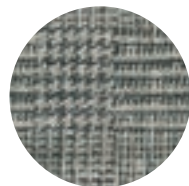

M004

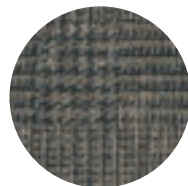

M005

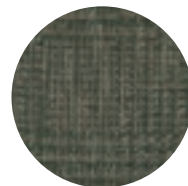

M006

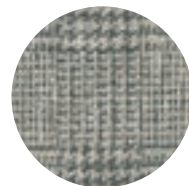

M007

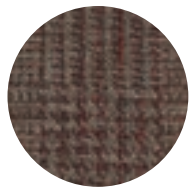

M008



M009

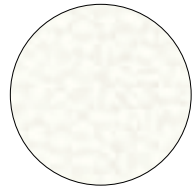

E201



E202



E203



E204

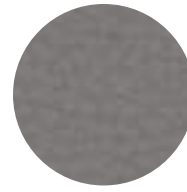

E205

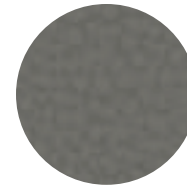

E206



E207

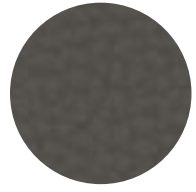

E208

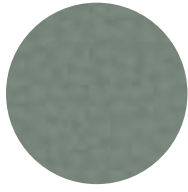

E209

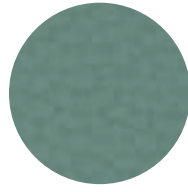

E210

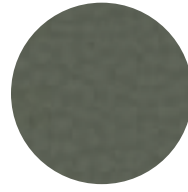

E211



E212

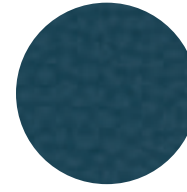

E213

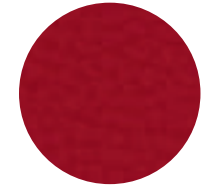

E214



E215



E216



E217

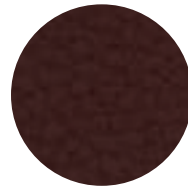

E218



E219



E220



E221

LETTI A TERRA/FLOOR-STANDING BEDS → P.334  
PONTI/BRIDGES → P.338  
SALVASPAZIO/SPACE-SAVING BEDS → P.342



## LETTI A TERRA

## FLOOR-STANDING BEDS



S22\_T01

→ P.008



S22\_T02

→ P.022



S22\_T03

→ P.036



S22\_T04

→ P.048



S22\_T05

→ P.060



S22\_T06

→ P.074



S22\_T07

→ P.086



S22\_T08

→ P.098





S22\_T09

→ P.110



S22\_T10

→ P.122



S22\_T11

→ P.132



S22\_T12

→ P.144





S22\_P13

→ P.158



S22\_P14

→ P.170



S22\_P15

→ P.182



S22\_P16

→ P.194



S22\_P17

→ P.206



S22\_P18

→ P.218



S22\_P19

→ P.228



S22\_P20

→ P.240



S22\_P21

→ P.254



S22\_P22

→ P.266





S22\_S23

→ P.278



S22\_S24

→ P.288



S22\_S25

→ P.300



S22\_S26

→ P.310

# ITALIER

[www.italier.cz](http://www.italier.cz) | [obchod@italier.cz](mailto:obchod@italier.cz) | +420 774 431 196