

ITALIER

DIAMANTE COLLECTION

ADORA

LUXURY-À-PORTER

Arredoclassic presenta Adora, luxury-à-porter, il nuovo brand dell'azienda. Adora nasce dall'esperienza di Arredoclassic e va ad affiancarsi alle collezioni del brand storico, proponendo un nuovo modo di guardare al design italiano: un'eleganza contemporanea che ispira interni di lusso. Il marchio Adora ha uno sguardo attento alle rapide variazioni del gusto di chi ricerca la bellezza ed uno stile raffinato e attuale. Da questa intuizione prende forma Adora: luxury-à-porter, un nome che racchiude la filosofia dell'intero progetto.

Adora luxury-à-porter è il piacere del lusso del design italiano coniugato con soluzioni produttive vantaggiose, concedendo così a un ampio pubblico la possibilità di scegliere ambienti prestigiosi senza mai snaturare il valore della qualità delle finiture e dei dettagli.

Le collezioni di arredamento firmate Adora segnano nuova esperienza del classico, per interni glamour dalla inconfondibile personalità.

Arredoclassic presents Adora, luxury-à-porter, the latest company brand. Adora is born out of Arredoclassic's experience a welcome addition to the other collections of this historic brand. It represents a new way of contemplating Italian design: contemporary elegance as the inspiration behind luxury interiors. The Adora line pays close attention to the changing tastes of those seeking out beauty and a refined, contemporary style. This intuition underpins Adora, luxury-à-porter, a name which in turn embodies the entire design philosophy.

Adora, luxury-à-porter marries the luxury of Italian design with winning product solutions, reaching out to the widest customer base with a choice of refined interiors and ensuring quality from detail to finish.

The Adora furnishing collection signals a new take on the classic providing glamorous interiors and unmistakable character.

Arredoclassic rappresenta Adora, luxury-à-porter, nuovo brand della compagnia. Adora è nata come risultato dell'esperienza accumulata dalla compagnia Arredoclassic e viene presentata insieme alle collezioni del brand storico, proponendo un nuovo modo di guardare al design italiano: un'eleganza contemporanea che ispira interni di lusso. Il marchio Adora ha uno sguardo attento alle rapide variazioni del gusto di chi ricerca la bellezza ed uno stile raffinato e attuale. Da questa intuizione prende forma Adora: luxury-à-porter, un nome che racchiude la filosofia dell'intero progetto.

Adora luxury-à-porter è il piacere del lusso del design italiano coniugato con soluzioni produttive vantaggiose, concedendo così a un ampio pubblico la possibilità di scegliere ambienti prestigiosi senza mai snaturare il valore della qualità delle finiture e dei dettagli. Le collezioni di arredamento firmate Adora segnano nuova esperienza del classico, per interni glamour dalla inconfondibile personalità.





DIAMANTE COLLECTION

La collezione Diamante si ispira al taglio geometrico della pietra più ambita per creare linee preziose che raccontano tutta la qualità del Made in Italy. Ogni segno della collezione Diamante riporta al gusto raffinato della lavorazione minuziosa dei gioielli, ogni elemento è studiato nel dettaglio per conferire al carattere contemporaneo che la contraddistingue, l'eleganza degli interni di pregio. La collezione Diamante si fa ammirare come un gioiello e, proprio come un gioiello, gioca con le infinite sfaccettature del vetro e della luce, senza dimenticare l'abile gioco di contrasti cromatici che ne esalta i volumi e le forme. Affascinante e complesso come il taglio di una gemma preziosa, così è il Concept alla base della collezione Diamante: poche e semplici linee si intersecano per dare vita a cornici con finitura in legno di olmo che contengono, nel loro abbraccio, tutta la sofisticata bellezza del vetro più luminoso.

Il team di tecnici di Adora che hanno progettato e realizzato questa nuova collezione DIAMANTE, ha selezionato per le maniglie, i fregi ed alcune gambe di supporto degli elementi di questa collezione, un nuovo materiale altamente tecnologico e performante denominato TECRES®. Il TECRES® si ottiene da una estrusione di polimeri che vengono compressi ad altissima pressione in stampi di acciaio.

Gli elementi così ottenuti risultano essere estremamente robusti ed indeformabili e vengono quindi rifiniti con cromatura oro lucido che manterranno inalterata la lucentezza dell'oro nel tempo escludendo fastidiosi problemi di ossidazione.

The Diamante collection takes its inspiration from the geometric shapes found in cut diamonds, enhancing beautiful lines representing the very best of Made In Italy. Each motif in the Diamante collection reflects the refined taste inherent in the fine work of the jeweller, with the detail in each item developed to ensure it has that contemporary feel which makes it stand out elegantly in any prestige interiors. The Diamante collection is to be admired like a jewel. Just like jewels, its pieces play with the light dancing off the infinite reflective properties of glass, not to mention the lively colour contrasts highlighted by their size and shape. As fascinating and complex as the surface of a precious gemstone, this is the basic concept behind the Diamante collection. A few simple lines intersect to bring forth the frames finished in elm wood, cradling all the sophisticated beauty of the brightest glass surfaces.

The technical team at Adora who designed and created this new DIAMANTE collection chose a new highly technical and effective material called TECRES®. It has been used to create the handles, mouldings and other supporting components in this collection. TECRES® is obtained by polymer extrusion which is then compressed at high pressure in steel presses.

The resulting pieces are extremely hard and robust, and have a bright gold chrome finish. This finish will maintain a perfect shine on the gold over time, eliminating annoying problems of oxidation.

Прециозная огранка самого желанного камня вдохновила на создание благородных линий коллекции Diamante, которая представляет собой качество с осязанием Made in Italy. Каждый штрих коллекции Diamante ассоциируется с точной обработкой драгоценных камней, выполненной с изысканным вкусом, каждый элемент продуман до мелочей, чтобы придать ее характерным современным чертам элегантность интерьеров высокого класса. Коллекцией Diamante можно любоваться как ювелирным творением. Подобно настоящей драгоценности она играет своими бесчисленными гранями из стекла и света, в ней искусно используются цветовые контрасты, чтобы выделить ее объемы и формы. Завораживающая и многогранная словно драгоценный камень - в этом заключается концепция, положенная в основу коллекции Diamante: пересечение немногочисленных простых линий создает обрамление с деревянной отделкой из вяза, которое окаймляет сверкающее стекло изысканной красоты.

Специалисты бренда Adora, которые разработали и изготовили коллекцию DIAMANTE, выбрали для ручек, фриз и некоторых опорных ножек элементов этой коллекции новый, высокотехнологичный и высококачественный материал под названием TECRES®. TECRES® получается экструзией полимеров, которые под высоким давлением запрессовываются в формы из нержавеющей стали.

Изготовленные таким образом элементы являются очень прочными и не подвержены деформированию. В дальнейшем на них наносится блестящее хромированное покрытие цвета золота, которое не теряет своего блеска с течением времени и исключает проблемы окисления.





I sofà della collezione Diamante sono leggeri e slanciati, merito della trapuntatura verticale ornata di bottoni dai riflessi aurei. Il metallo lucido color oro, in abbinamento con i morbidi velluti personalizzabili, conferisce a questi elementi una speciale alchimia, in equilibrio tra comfort e design. A conferire un tocco glamour, i cuscini dorati che movimentano e danno luce alla composizione.

The sofas in the Diamante collection are light and slender, highlighted by the vertical quilting decorated with golden buttons. The bright golden metal combined with a choice of soft velvets give these pieces a special alchemy, a balance of comfort and design. The golden cushions provide a touch of glamour, bringing movement and light to the whole composition.

Диваны коллекции Diamante обладают легким и утонченным силуэтом благодаря вертикальной стежке, украшенной переливающимися золотистыми пуговицами. Блестящий металл цвета золота в сочетании с бархатной персонифицируемой обивкой придает этим элементам особое очарование, равновесие между комфортом и дизайном. Позолоченные подушки добавляют некоторую гламурность, они оживляют дизайн и образуют композицию.





Gli elementi della zona giorno esprimono a pieno le caratteristiche fondamentali della collezione Diamante. Le linee sobrie ma ben marcate delle cornici in finitura olmo generano l'intreccio geometrico che dà origine al leitmotiv di tutta la collezione: un elegante triangolo che richiama le sfaccettature del diamante che va a incastonarsi agli spigoli delle vetrine. Lo stesso elemento si ripropone anche nel mobile orizzontale a cui si abbinano le gambe nell'innovativo materiale TECRES® a finitura cromata in oro.

The living room pieces display all the fundamental characteristics of the Diamante collection. The sober but well-defined shapes of the frame finished in elm wood generate a geometric interplay from which the entire collection's leitmotif springs: an elegant triangle resembling the facets of a cut diamond is set into the corners of the display cabinets. This same feature appears again on the horizontal cabinet which has legs crafted from the innovative TECRES® material combined with a gold chrome finish.

Элементы дневной зоны в полной мере представляют собой основные характеристики коллекции Diamante. Строгие линии, подчеркнутые обрамлением с отделкой из вяза, образуют геометрический рисунок, который служит лейтмотивом всей коллекции: элегантный треугольник, напоминающий грани бриллианта, которым словно инкрустированы края шкафов-витрин. Эта же деталь вновь появляется в горизонтальной мебели в сочетании с ножками из инновационного материала TECRES® с хромированным покрытием цвета золота.





L'INCLITE AZIONI CELEBRA,
GLI EROI PER LA SUA TROMBA
A ETERNA VITA SORGONO
DALLA GELATA TOMBA.

TIEN ELLA IN EQUILIBRIO
I FISSI MONDI E ERRANTI:
PER LEI L'ARIA S'IMBALSAMA
DI DOLCI SUONI E CANTI.

Fabric - Ткань cat B art. Luz 3021 (LZ2)







NULLA È SENZA DI NOI VENERE ISTESSA

DEI SENSI DEL CUOR ARBITRA,
DELLE GRAZIE MAESTRA
CON GESTI ESPRIME L' ANIMA,
E LA NATURA ADDESTRÀ.



L'ampia superficie vetrata, che si riflette nel fondo a specchio delle vetrine a due ante, amplifica la luce e fa scintillare lo spazio circostante. Elementi immaginati non solo per contenere e mostrare gli oggetti, ma anche per lasciare un segno indelebile nello spazio che vanno ad arredare. Fa loro eco il tavolo che, con la solida geometria della grande piana, è il giusto contrappunto per bilanciare la consistenza eterea delle vetrine.

The large glazed surfaces of these double-door cabinets are reflected in the mirrored back panel which amplifies any light and makes the surrounding space sparkle. These furniture pieces are designed not just to contain and display objects, but also to leave an indelible impression upon the space they inhabit. This effect is echoed in the table, whose large surface has a solid geometry, and is the perfect counterpoint to balance the ethereal nature of the cabinets.

Широкая застекленная поверхность отражается в зеркальной задней стенке двустворчатого шкафа-витрины, усиливает освещение и заставляет сверкать окружающее пространство. Эти элементы предназначены не только для хранения и демонстрации предметов, но и для создания яркого эффекта в обставленной ими комнате. С ними перекликается стол с большой столешницей строгой геометрической формы, который является точным повторением шкафов-витрин и уравнивает их воздушность.





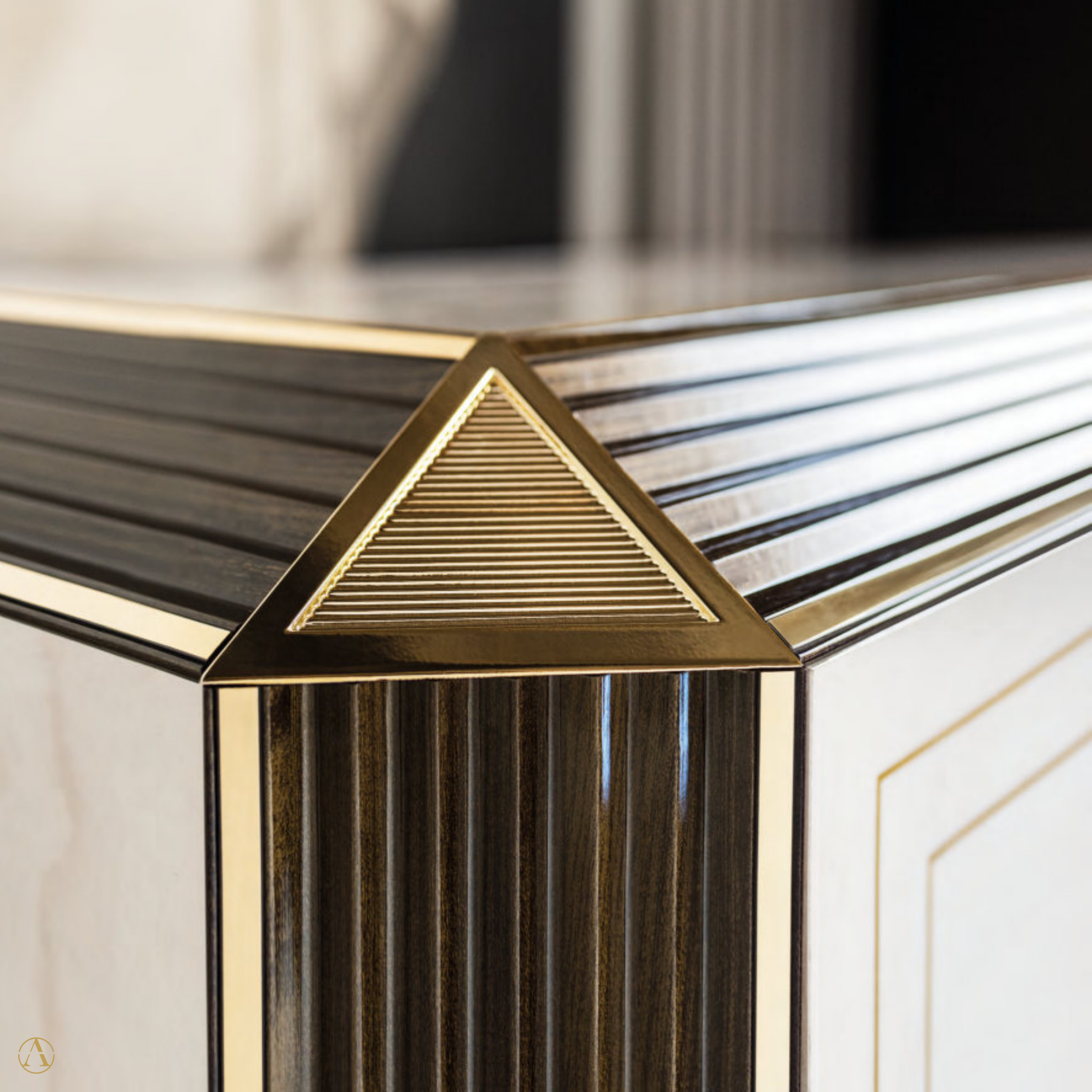



VAI CA LE SFERE, INCHINASI
A LEI L'ETEREA MOLE
SCANDAGLIA GLI ASTRI SUTTI
DAL PADUCLON DEL SOLE.

DEI SENSI, DEL CUOR ARBITRA,
DELLE GRAZIE MAESTRA,
COI GESTI ESPRIME L'ANIMA,
E LA NATURA ADDESTRA.



Fabric - Ткань cat B art. Luz 7608 (LZ1)





DIAMANTE COLLECTION

3 Seats Sofa

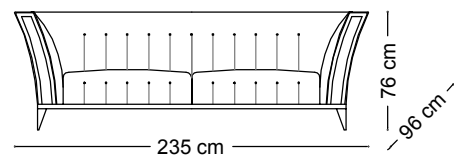

2 Seats Sofa

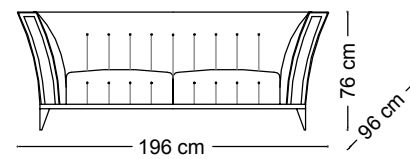

Armchair

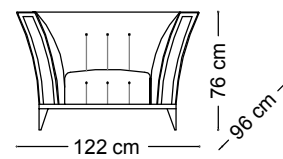

Chaise Longue

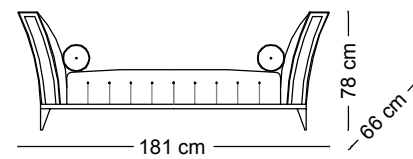

TV Composition 15

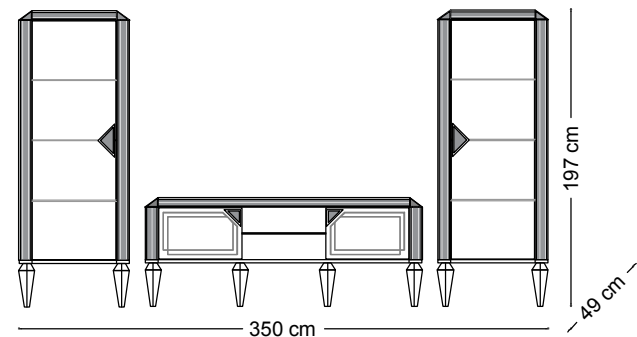

Lamp/End Table

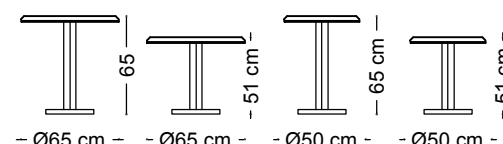

Coffee Table

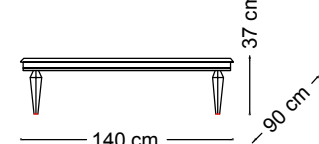

2 Doors Glass Cabinet

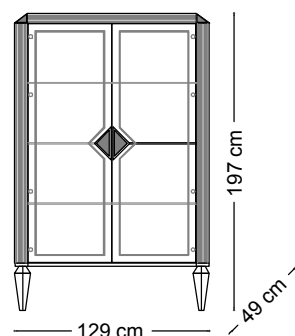

1 Door Glass Cabinet

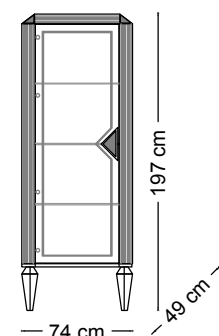

Small 2 Doors Cabinet With Glass Doors

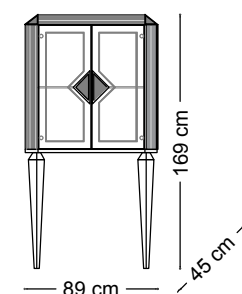

Small 2 Doors Cabinet With Wooden Doors

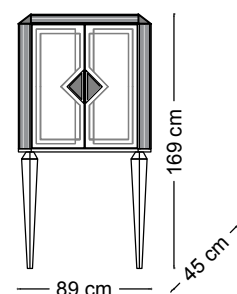

Square Table w/1 Extension

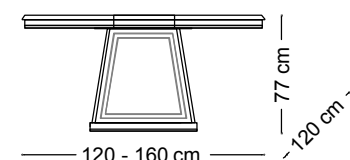

Round Table

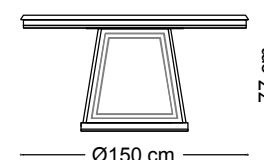

Rectangular Fix Table

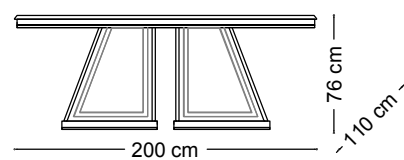

Rectangular Table w/1 Extension

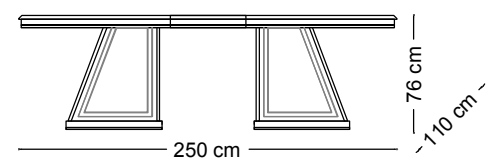

Rectangular Table w/2 Extensions

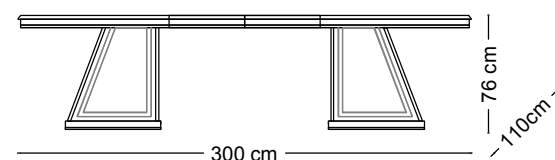

Chair

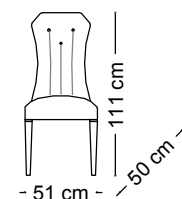

4 Doors Buffet

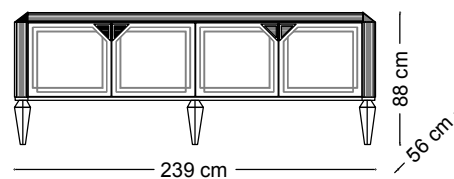

Big Mirror

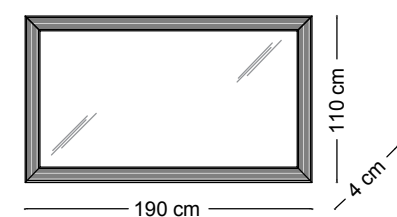

Console

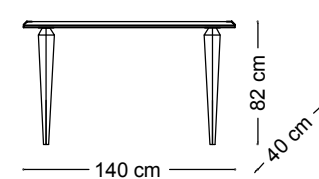

Small Mirror

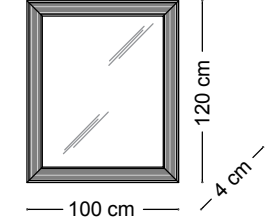

TV Cabinet

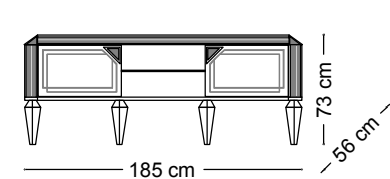

4 Doors Wardrobe

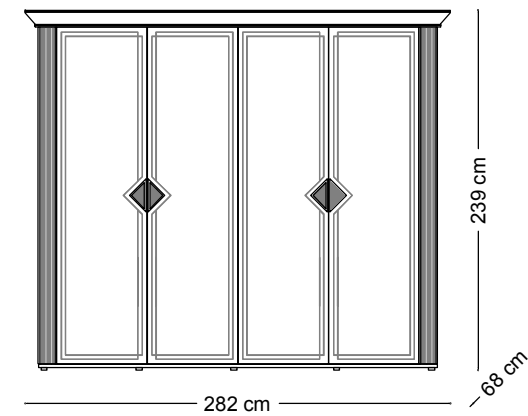

2 Doors Wardrobe

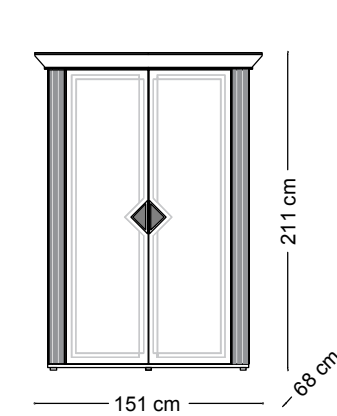

3 Drawers Dresser

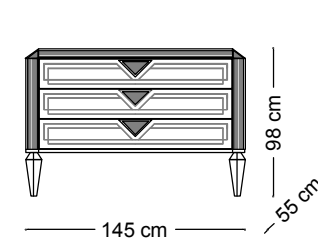

Small Mirror

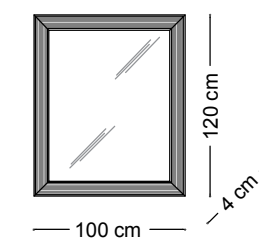

Dressing Table

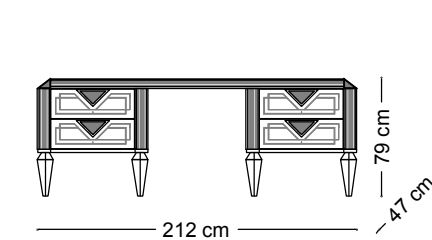

Big Mirror

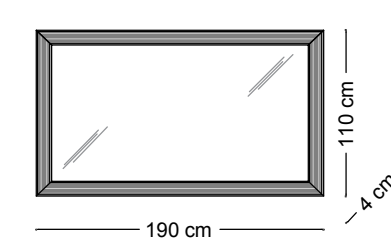

Pouf

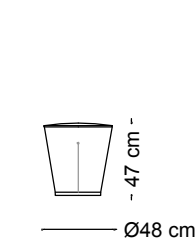

Bed King Size cm 180/200 x 200

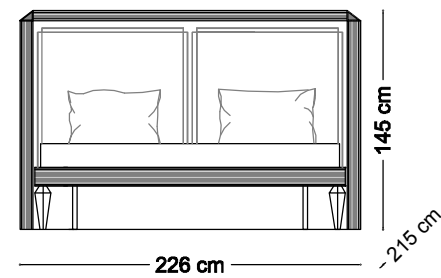

Bed Italian Size cm 160 x 190

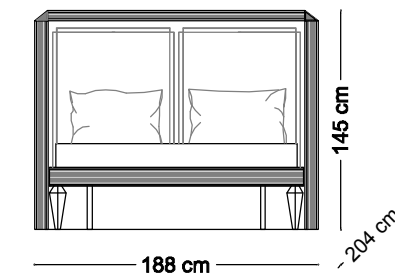

Bed Queen Size cm 160 x 200

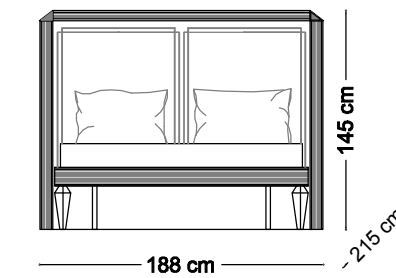

Night Table

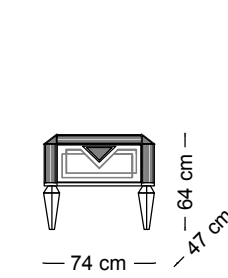

Upholstered Bed King Size cm 180/200 x 200

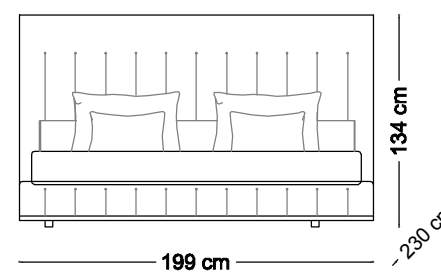

Upholstered Bed Italian Size cm 160 x 190

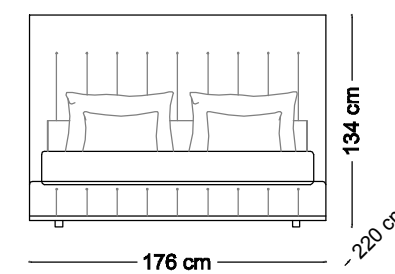

Upholstered Bed Queen Size cm 160 x 200

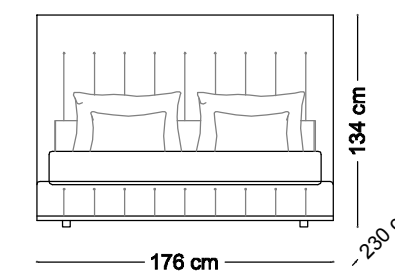

Upholstered Bed With Container

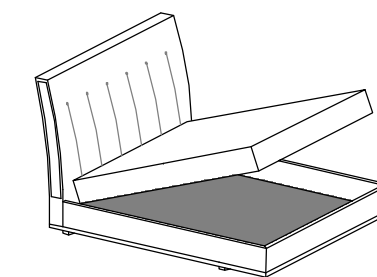

ITALIER

www.italier.cz | info@italier.cz | +420 774 431 196