

re≡ind

Rewind è il nuovo sistema cucina di Creo Kitchens. Ogni modello esprime possibilità diverse di vivere l'ambiente cucina, con un denominatore comune: la funzionalità estetica. Caratterizzata da un'infinita componibilità, il modello Rewind ha alcuni elementi che lo rendono unico e speciale, come le nuove maniglie di design create ad hoc dalla linea squadrata e le esclusive ante decorate artigianalmente.

Elementi a giorno tradizionali o in alluminio per uno stile più moderno, fianconi di spessore 76 mm dal design deciso, telai in alluminio costruiti per dare un frame continuo ai pensili chiusi sono solo alcuni dettagli distintivi di questa cucina pensata per il comfort e la praticità.

Tutte le ante hanno uno spessore di 22 mm e sono disponibili in nuove essenze: frassino creta, pine cipria, pine polar, faggio naturale, rovere gessato e noce, inediti e attuali colori anche per le laccature oltre alle possibilità classiche di Creo Kitchens.

La grande scelta di finiture e colori assicura la personalizzazione in configurazioni che si adattano a qualsiasi esigenza. Con Rewind ognuno può trovare il suo mondo: focolare domestico, esperienza sensoriale, luogo formale di ospitalità, spazio libero di condivisione.





CREO ECOLOGIC

IL GRUPPO LUBE HA SCELTO DI UTILIZZARE PER I COMPONENTI COSTITUENTI LE STRUTTURE DELLE CUCINE SOLO MATERIALE A BASSISSIMA EMISSIONE DI FORMALDEIDE: CONFORMI ALLO STANDARD F4STELLE SECONDO LA NORMA JIS, CERTIFICATO DAL MINISTERO GIAPPONESE, IL PIU' SEVERO IN MERITO ALLE NORMATIVE DI SALVAGUARDIA AMBIENTALE.

Regarding the production of its kitchen structure components, lube group has decided to only use materials featuring very low formaldehyde emissions complying with the 4-star standard, as defined by the jis regulation. This standard is certified by the japanese government-the most rigorous when it comes to environmental protection.

Rewind is the new kitchen system from Creo Kitchens. Each model expresses different ways of experiencing the kitchen, with one common denominator: aesthetic functionality. Characterised by limitless modularity, the Rewind model has several elements that make it special and unique, such as the new designer handles created ad hoc with a square form and exclusive hand-finished decoration.

Traditional or aluminium open elements for a more modern style, side panels 76 mm thick with a strong design and aluminium frames made to give a continuous frame to the closed wall units are just a few of the distinctive details of this kitchen, designed for comfort and practicality.

All the doors are 22 mm thick and are available in new woods: clay ash, pale pink pine, polar pine, natural beech, pinstriped oak and walnut, trendy and unusual colours for the lacquers too, as well as the classic Creo Kitchens colours. The great choice of finishes and colours ensures a high level of customisation and configurations to suit any requirement. With Rewind everyone can find their own world: domestic hearth, sensory experience, formal entertaining space or open space for sharing.

re≲ind melaminico

SP. 22 MM

CARATTERISTICHE TECNICHE

ANTE E FRONTALI CASSETTI anta con cornice in massello di frassino tinto a poro aperto sp.22 mm e cartella in melaminico sp.18 mm nei colori: frassino creta (opz.2401), pine cipria (opz.3051), pine polar (opz.3052) rovere grigio gessato (opz.5330), noce brown (opz.2371)

ANTE VETRO telaio in alluminio finitura titanio e brill sp.22 mm, vetro colorato sp.4 mm (per colori vedi pag.17)

GOLA tipo "ELLE"
 N.B.: per le finiture gole vedi pag.23



MANIGLIE vedi pag.28-29

STRUTTURE

ANTE: PINE POLAR
 nobilitato perla d'oriente (opz.940), schiena e ripiano bianco (opz.001)

ANTA: PINE CIPRIA
 nobilitato visone (opz.948M) schiena e ripiano visone (opz.948M)

ANTE: FRASSINO CRETA, NOCE BROWN
 nobilitato fango (opz.8860) schiena e ripiano fango (opz.8860)

ANTA: ROVERE GRIGIO GESSATO
 nobilitato lavagna (opz.9620) schiena e ripiano lavagna (opz.9620)



MENSOLE

di serie: altezza 3,8 cm in nobilitato perla d'oriente (opz.940), visone (opz.948M), fango (opz.8860), lavagna (opz.9620)
a richiesta: altezza 3,8 cm in nobilitato frassino creta (opz.2401), pine cipria (opz.3051), pine polar (opz.3052), faggio naturale (opz.1569), rovere grigio gessato (opz.5330), noce brown (opz.2371)

ZOCCOLI

di serie: altezza 13 cm in pvc ricoperti in melamina initura acciaio (opz.407)
a richiesta: altezza 13 cm in alluminio initura brill (opz.412), titanio ossidato (opz.414),
 altezza 13 cm in alluminio verniciato a polvere initura opaca nei colori

TECHNICAL SPECIFICATIONS

DOORS AND DRAWERS FRONTS

door with frame in solid ash with an open pore finish, 22 mm thick with 18 mm thick melamine panel in the following colours: clay ash (opt.2401), pale pink pine (opt.3051), polar pine (opt.3052), pinstripe grey oak (opt.5330), brown walnut (opt.2371)

GLASS DOORS

aluminium frame in titanium and brill finish, 22 mm thick, coloured glass 4 mm thick (for colours see page 17)

FINGER RAIL

"L" shaped

NOTE: for the finger rail finishes see page 23



HANDLES

see page 28-29

CARCASSES

DOORS: POLAR PINE

oriental pearl (opt.940), white back panel and shelf (opt.001)

DOOR: PALE PINK PINE

mink (opt.948M), mink back panel and shelf (opt.948M)

DOORS: CLAY ASH, BROWN WALNUT

mud (opt.8860), mud back panel and shelf (opt.8860)

DOOR: PINSTRIPE GREY OAK

slate grey (opt.9620), slate grey back panel and shelf (opt.9620)

SHELVES

standard: height 3.8 cm, in oriental pearl (opt.940), mink (opt.948M), mud (opt.8860), slate grey (opt.9620)

on request: height 3.8 cm, in clay ash (opt.2401), pale pink pine (opt.3051), polar pine (opt.3052), natural beech (opt.1569), pinstripe grey oak (opt.5330) and brown walnut (opt.2371)

PLINTHS

standard: height 13 cm, melamine-faced PVC with steel finish (opt.407)

on request: height 13 cm, in aluminium with brill finish (opt.412) oxidised titanium (opt.414), height 13 cm, in matt powder-coated aluminium for colours



re≠ind melaminico melamine

Neck cod. **K36**
 Bridge cod. **K33**

ante con cornice in massello di frassino tinto a poro aperto e cartella in melaminico
 doors with frame in stained solid ash with open pore finish and melamine panel



frassino creta (opz.2401)
 clay ash (opt.2401)



pine cipria (opz.3051)
 pale pink pine (opt.3051)



noce brown (opz.2371)
 brown walnut (opt.2371)



particolare anta anteriore
 front edge door detail



particolare anta posteriore
 rear edge door detail



rovere grigio gessato (opz.5330)
 pinstripe grey oak (opt.5330)



pine polar (opz.3052)
 polar pine (opt.3052)

SP. 22 MM
TH. 22 MM

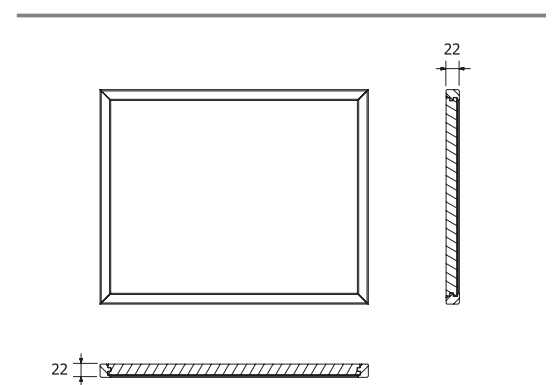

re≡ind laccato opaco

SP. 22 MM

CARATTERISTICHE TECNICHE

ANTE E FRONTALI CASSETTI anta in mdf sp.22 mm pantografata e laccata con finitura opaca microstrutturata
N.B.: per i colori vedi pag.15

ANTE VETRO telaio in alluminio finitura titanio e brill sp.22 mm, vetro colorato sp.4 mm (per colori vedi pag.17)

GOLA tipo "ELLE"
N.B.: per le finiture gole vedi pag.23



MANIGLIE
vedi pag.28-29

STRUTTURE

ANTE: PLATINO, NOCCIOLA
 nobilitato perla d'oriente (opz.940), schiena e ripiano bianco (opz.001)

ANTA: CUOIO
 nobilitato fango (opz.8860) schiena e ripiano fango (opz.8860)

ANTA: GRIGIO PIOMBO
 nobilitato lavagna (opz.9620) schiena e ripiano lavagna (opz.9620)

ANTA: POLVERE
 nobilitato bianco (opz.001) schiena e ripiano bianco (opz.001)

ANTA: CANAPA
 nobilitato devalè finitura grafis (opz.796) schiena e ripiano bianco (opz.001)



MENSOLE altezza 3,8 cm laccate come ante

ZOCCOLI

di serie: altezza 13 cm in pvc ricoperti in melamina finitura acciaio (opz.407)
a richiesta: altezza 13 cm in alluminio finitura brill (opz.412), titanio ossidato (opz.414),
 altezza 13 cm in alluminio verniciato a polvere finitura opaca nei colori

re≡ind matt lacquered

Neck
Bridge

cod. **K37**

cod. **K34**

TH. 22 MM

TECHNICAL SPECIFICATIONS

DOORS AND DRAWERS FRONTS

22 mm thick MDF door with micro-structured matt lacquer finish

NOTE: for the colours see page 15

GLASS DOORS

aluminium frame in titanium and brill finish, 22 mm thick, coloured glass 4 mm thick (for colours see page 17)

FINGER RAIL

"L" shaped

NOTE: for the finger rail finishes see page 23



HANDLES

see page 28-29

CARCASSES

DOORS: PLATINUM, HAZEL
oriental pearl (opt.940), white back panel and shelf (opt.001)

DOOR: LEATHER
mud (opt.8860), mud back panel and shelf (opt.8860)

DOOR: LEAD GREY
slate grey (opt.9620), slate grey back panel and shelf (opt.9620)

DOOR: POWDER
white (opt.001), white back panel and shelf (opt.001)

DOOR: HEMP
devalè with grafis finish (opt.796), white back panel and shelf (opt.001)

SHELVES

height 3.8 cm, lacquered in same finish as doors

PLINTHS

standard: height 13 cm, melamine-faced PVC with steel finish (opt.407)

on request: height 13 cm, in aluminium with brill finish (opt. 412) oxidised titanium (opt. 414),

height 13 cm, in matt powder-coated aluminium for colours



rewind

laccato opaco

matt lacquered

Neck
Bridge

cod. **K37**

cod. **K34**

ante laccate con finitura opaca microstrutturata
lacquered doors with matt micro-structured finish

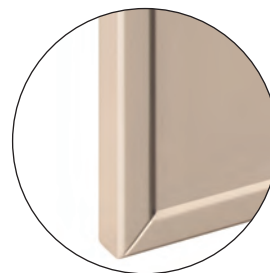

particolare anta anteriore
front edge door detail



particolare anta posteriore
rear edge door detail

SP. 22 MM
TH. 22 MM

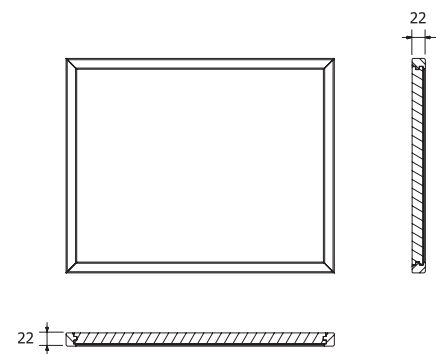

[CLICCA QUI PER LA GAMMA COLORI DISPONIBILI](#)

[CLICK HERE FOR THE RANGE OF AVAILABLE COLORS](#)



re∑ind vetro glass

ante vetro con telaio alluminio finitura brill e titanio
glass doors with aluminium frame in brill and titanium finish



anta centrale (opz.C)
central door (opt.C)



anta laterale sx (opz.S)
LH side door (opt.S)



anta laterale dx (opz.D)
RH side door (opt.D)

N.B.: anta centrale (di serie) utilizzabile singolarmente o in combinazione con le ante laterali sx/dx
Note: central door (as standard) can be used individually or in combination with LH/RH side doors

telaio frame



brill
brill



titanio
titanium

N.B.: ante laterali sx/dx da utilizzare esclusivamente inizio/fine composizione
Note: LH/RH side doors to be used exclusively at the start/end of the composition

colori vetri satinati satin glasses colours



vetro creta
- telaio brill (opz.BRCR_)
- telaio titanio (opz.TRCR_)
in abbinamento con frassino creta (opz.2401)
clay glass
- brill frame (opt.BRCR_)
- titanium frame (opt.TRCR_)
in combination with clay ash (opt.2401)



vetro cipria
- telaio brill (opz.BRCI_)
- telaio titanio (opz.TRCI_)
in abbinamento con pine cipria (opz.3051)
pale pink glass
- brill frame (opt.BRCI_)
- titanium frame (opt.TRCI_)
in combination with pale pink pine (opt.3051)



vetro natur
- telaio brill (opz.BRNA_)
- telaio titanio (opz.TRNA_)
in abbinamento con faggio naturale (opz.1569)
natural glass
- brill frame (opt.BRNA_)
- titanium frame (opt.TRNA_)
in combination with natural beech (opt.1569)



vetro arena
- telaio brill (opz.BRAR_)
- telaio titanio (opz.TRAR_)
in abbinamento con rovere grigio gessato (opz.5330)
arena glass
- brill frame (opt.BRAR_)
- titanium frame (opt.TRAR_)
in combination with pinstripe grey oak (opt.5330)



vetro polar
- telaio brill (opz.BRPO_)
- telaio titanio (opz.TRPO_)
in abbinamento con pine polar (opz.3052)
polar glass
- brill frame (opt.BRPO_)
- titanium frame (opt.TRPO_)
in combination with polar pine (opt.3052)

colori vetri semitrasparenti semi-transparent glasses colours



vetro bronzato
- telaio brill (opz.BRBR_)
- telaio titanio (opz.TRBR_)
in abbinamento con noce brown (opz.2371)
bronzed glass
- brill frame (opt.BRBR_)
- titanium frame (opt.TRBR_)
in combination with brown walnut (opt.2371)

SP. 22 MM
TH. 22 MM

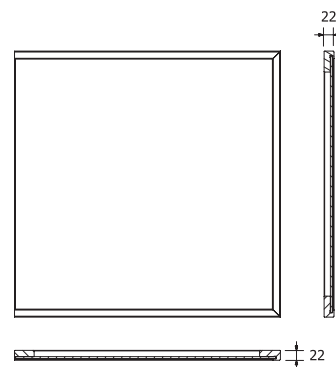

anta MODULO LATERALE
door SIDE MODULE

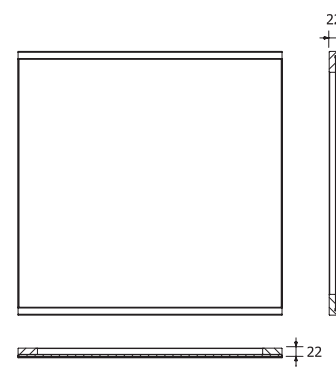

anta MODULO CENTRALE
door CENTRAL MODULE



Neck

FINITURE GOLE

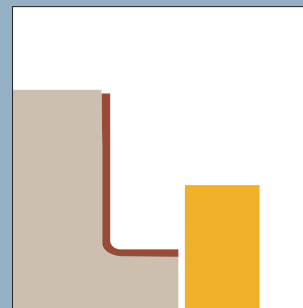

GOLA TIPO "ELLE"

"ELLE" TYPE FINGER RAIL

FINITURE GOLE SPAZZOLATE FINGER RAILS BRUSHED FINISHES

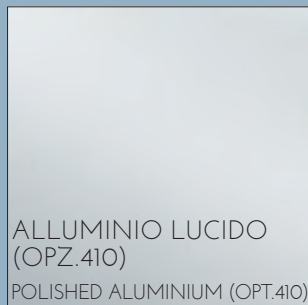



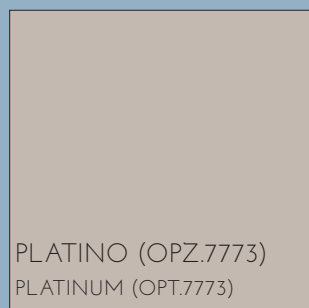
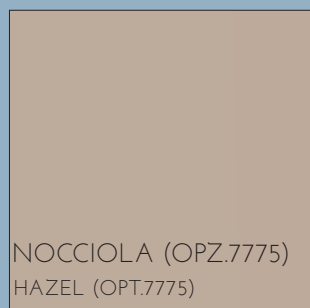
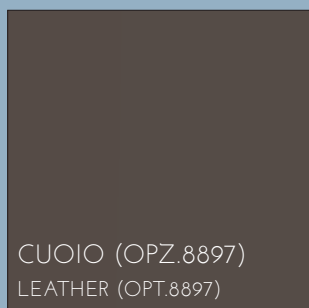
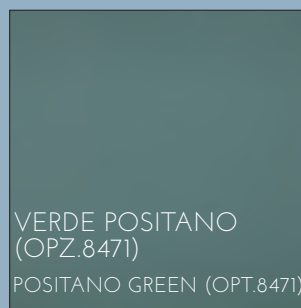
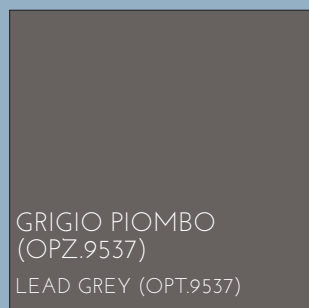
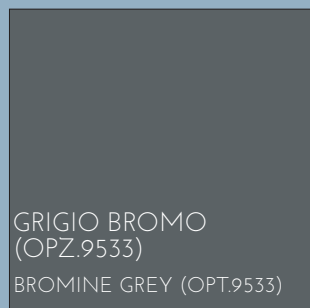
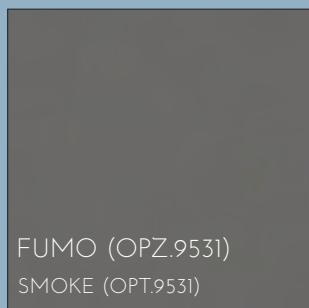
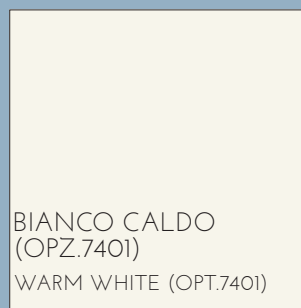
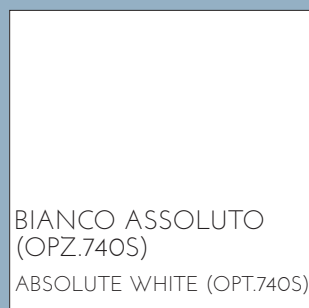
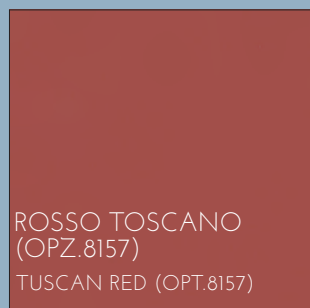
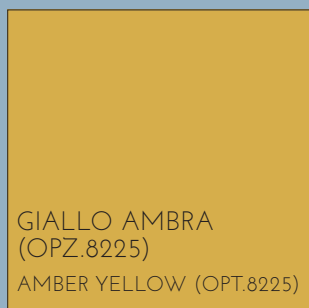
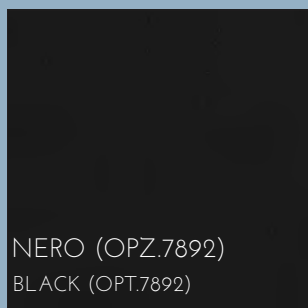

FINITURE GOLE VERNICIATE A POLVERE OPACHE MATT FINGER RAILS POWDER COATED FINISHES



GOLA "ELLE" ORIZZONTALE SOTTOTOP

UNDERMOUNT HORIZONTAL "ELLE" FINGER RAIL

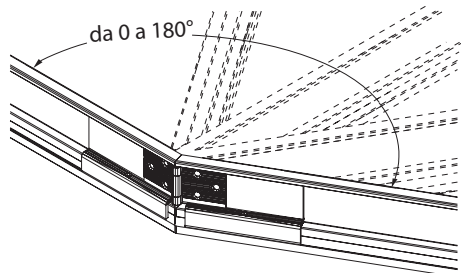

	COD.			COD.		
<p>Gola sottotop tipo "A" Type "A" undermount finger rail</p> 	G950010	al ml per lm		<p>Angolo interno a 90° per gola tipo "A" 90° interior corner for "A" type finger rail</p> 	G950050	cadauno each
<p>Terminale aperto dx o sx per gola tipo "A" da utilizzare a fine composizione RH or LH open end for type "A" finger rail to be placed at the end of the composition</p> 				<p>Angolare con snodo per unione fuori squadra per gola tipo "A" Corner piece with joint for out-of-plumb joining for type "A" finger rail</p> 		
		in alluminio aluminium				
		terminale DX RH end	G950021			
		terminale SX LH end	G950022			
		in plastica (solo finitura opz.410) plastic (only finish opt.410)				
		terminale DX RH end	G950041			
		terminale SX LH end	G950042			
<p>Terminale chiuso dx o sx per gola tipo "A" da utilizzare solo tra basi e colonne RH or LH closure for type "A" finger rail to be placed only between base units and column</p> 						
		in alluminio aluminium				
		terminale DX RH end	G950031			
		terminale SX LH end	G950032			
		in plastica (solo finitura opz.410) plastic (only finish opt.410)				
		terminale DX RH end	G950045			
		terminale SX LH end	G950046			
						G950060



GOLA "ELLE" ORIZZONTALE INTERMEDIA

INTERMEDIATE HORIZONTAL "ELLE" FINGER RAIL

GOLE "ELLE" VERTICALI PER COLONNE

VERTICAL "ELLE" FINGER RAILS FOR COLUMNS

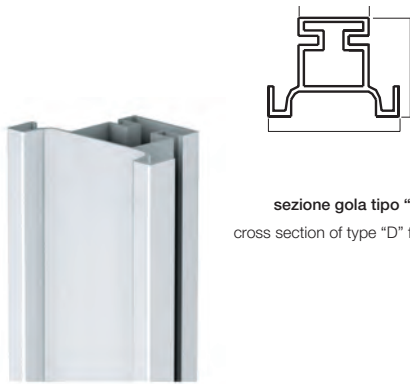
		COD.
<p>Gola intermedia tipo "B" Type "B" intermediate finger rail</p> 		
	al ml per lm	G950110
<p>Terminale aperto dx o sx per gola tipo "B" da utilizzare a fine composizione RH or LH open end for type "B" finger rail to be placed at the end of the composition</p> 	in alluminio aluminium	
	terminale DX RH end	G950121
	terminale SX LH end	G950122
	in plastica (solo finitura opz.410) plastic (only finish opt.410)	
	terminale DX RH end	G950141
	terminale SX LH end	G950142
<p>Terminale chiuso dx o sx per gola tipo "B" da utilizzare solo tra cassettiere e lavastoviglie/colonne RH or LH closure for type "B" finger rail to be placed only between drawer units and dishwasher/columns</p> 	in alluminio aluminium	
	terminale DX RH end	G950131
	terminale SX LH end	G950132
	in plastica (solo finitura opz.410) plastic (only finish opt.410)	
	terminale DX RH end	G950145
	terminale SX LH end	G950146

		COD.
<p>Mezza gola verticale tipo "C" (completa di distanziale) Type "C" half vertical finger rail (complete with spacer)</p>  <p style="text-align: center;">sezione mezza gola tipo "C" cross section of type "C" finger rail</p>	spaziatori H 13 feet H 13	
	H 96	G950310
	H 132	G950330
	H 204	G950350
	H 228	G950370
<p>Gola verticale intermedia tipo "D" (completa di distanziale) Type "D" intermediate vertical finger rail (complete with spacer)</p>  <p style="text-align: center;">sezione gola tipo "D" cross section of type "D" finger rail</p>	spaziatori H 13 feet H 13	
	H 96	G950410
	H 132	G950430
	H 204	G950450
	H 228	G950470
<p>Gola verticale laterale tipo "E" (completa di distanziale) Type "E" lateral vertical finger rail (complete with spacer)</p>  <p style="text-align: center;">sezione gola tipo "E" cross section of type "E" finger rail</p>	spaziatori H 13 feet H 13	
	H 96	G950510
	H 132	G950530
	H 204	G950550
	H 228	G950570

NOZIONI UTILI - gole "elle" orizzontali per basi

USEFUL INFORMATION - HORIZONTAL "ELLE" FINGER RAILS FOR BASE UNITS

VISTA FRONTALE ZOCCOLO H 13 PER BASI H 88

FRONT VIEW PLINTH H 13 FOR BASE UNITS H 88

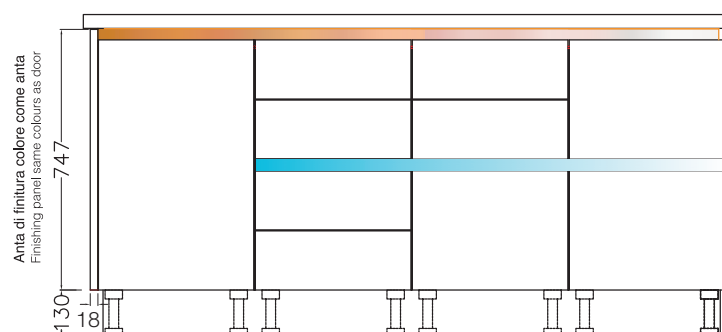
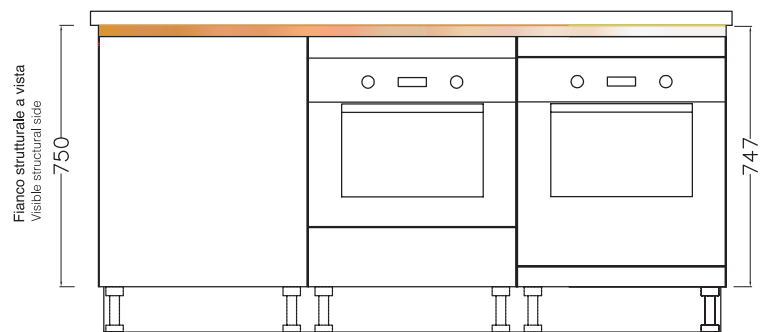

VISTA LATERALE (sezione) ZOCCOLO H 13 PER BASI H 88

SIDE VIEW (CROSS SECTION) PLINTH H 13 FOR BASE UNITS H 88

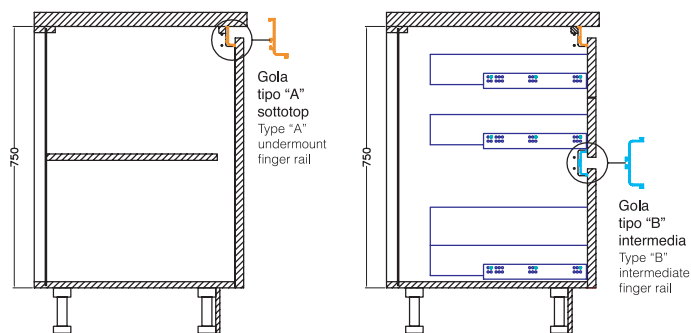

VISTA DALL'ALTO

TOP VIEW

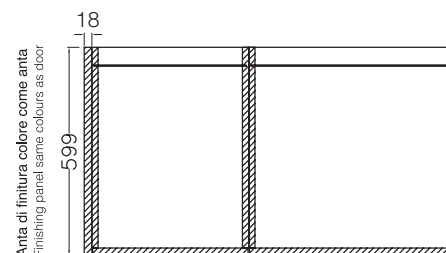
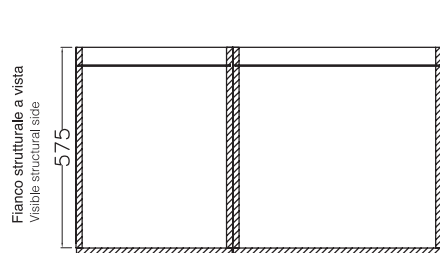

Composizione con ante di finitura laterali: alla dimensione finale della cucina, sommare sempre lo spessore delle ante di finitura (ogni anta 18 mm)

Composition with side finishing panels: to the final size of the kitchen, always add the thickness of the finishing panels (each panel 18 mm)

NOZIONI UTILI - gole "elle" verticali per colonne

USEFUL INFORMATION - VERTICAL "ELLE" FINGER RAILS FOR COLUMNS

VISTA FRONTALE ZOCCOLO H 13

FRONT VIEW PLINTH H 13

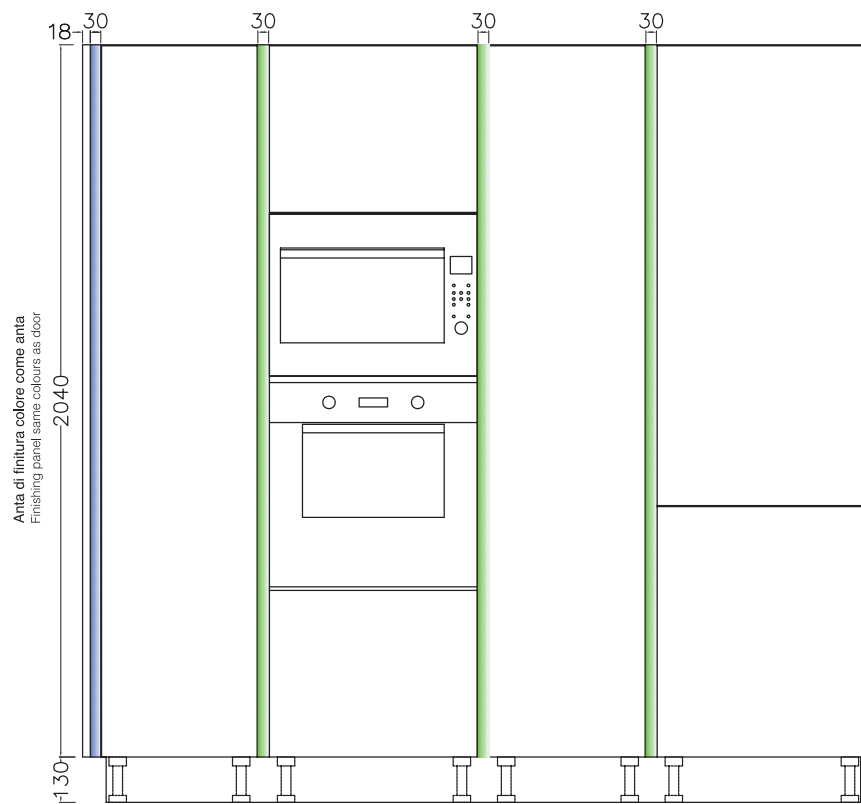

VISTA DALL'ALTO

TOP VIEW

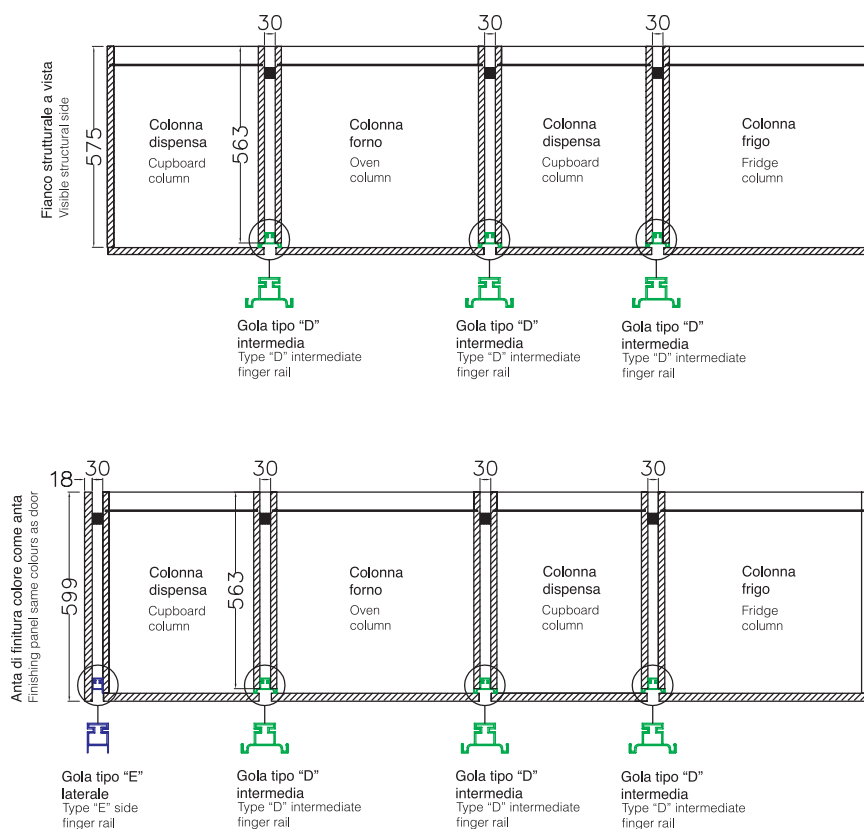

Composizione fianco strutturale a vista come anta: alla dimensione finale della cucina, sommare sempre lo spessore dei distanziali tra le colonne (ogni distanziale 3 cm)

Composition with visible side panel to match door: to the final size of the kitchen, always add the thickness of the spacers between the two columns (each spacer 3 cm)

Composizione con ante di finitura laterali, alla dimensione finale della cucina, sommare sempre lo spessore dei distanziali tra le colonne (ogni distanziale 3 cm) e lo spessore delle ante di finitura (ogni anta 18 mm)

Composition with side finishing panels to the final size of the kitchen, always add the thickness of the spacer between the two columns (each spacer 3 cm) and the thickness of the finishing panels (each panel 18 mm)

DI SERIE STANDARD



Maniglia 587 finitura titanio
 anta da L 30 a L 90 → passo 160 mm
N.B.: per gli elementi da 15 utilizzare la maniglia KL passo 32 mm (vedi pag.29)

Handle 587 titanium finish
 door from W 30 to W 90 → centre-to-centre distance 160 mm
NOTE: use KL handle with centre-to-centre distance 32 mm for 15 cm elements (see page 29)

A RICHIESTA ON REQUEST



Maniglia 588 finitura cromo opaco
 elementi da L 15 → Pomo
 anta da L 30 a L 60 → passo 160 mm
 anta L 90 → passo 320 mm

Handle 588 matt chrome finish
 elements W 15 → Knob hole
 door from W 30 to W 60 → centre-to-centre distance 160 mm
 door W 90 → centre-to-centre distance 320 mm



Maniglia K03 finitura acciaio satinato
 anta L 15 → passo 32 mm
 anta da L 30 a L 90 → passo 160 mm

Handle K03 satin steel finish
 door W 15 → centre-to-centre distance 32 mm
 door from W 30 to W 90 → centre-to-centre distance 160 mm



Maniglia 58FC finitura supporti nichel satinato
 inserto in tinta con anta frassino creta
 anta L 15 → passo 64 mm
 anta da L 30 a L 60 → passo 160 mm
 anta L 90 → passo 320 mm

Handle 58FC satin nickel finish supports
 insert match with clay ash door
 door W 15 → centre-to-centre distance 64 mm
 door from W 30 to W 60 → centre-to-centre distance 160 mm
 door W 90 → centre-to-centre distance 320 mm



Maniglia 58FN finitura supporti nichel satinato
 inserto in tinta con anta faggio naturale
 anta L 15 → passo 64 mm
 anta da L 30 a L 60 → passo 160 mm
 anta L 90 → passo 320 mm

Handle 58FN satin nickel finish supports
 insert match with natural beech door
 door W 15 → centre-to-centre distance 64 mm
 door from W 30 to W 60 → centre-to-centre distance 160 mm
 door W 90 → centre-to-centre distance 320 mm



Maniglia 58NB finitura supporti nichel satinato
 inserto in tinta con anta noce brown
 anta L 15 → passo 64 mm
 anta da L 30 a L 60 → passo 160 mm
 anta L 90 → passo 320 mm

Handle 58NB satin nickel finish supports
 insert match with brown walnut door
 door W 15 → centre-to-centre distance 64 mm
 door from W 30 to W 60 → centre-to-centre distance 160 mm
 door W 90 → centre-to-centre distance 320 mm



Maniglia 58PC finitura supporti nichel satinato
 inserto in tinta con anta pine cipria
 anta L 15 → passo 64 mm
 anta da L 30 a L 60 → passo 160 mm
 anta L 90 → passo 320 mm

Handle 58PC satin nickel finish supports
 insert match with pale pink pine door
 door W 15 → centre-to-centre distance 64 mm
 door from W 30 to W 60 → centre-to-centre distance 160 mm
 door W 90 → centre-to-centre distance 320 mm



Maniglia 58PP finitura supporti nichel satinato
 inserto in tinta con anta pine polar
 anta L 15 → passo 64 mm
 anta da L 30 a L 60 → passo 160 mm
 anta L 90 → passo 320 mm

Handle 58PP satin nickel finish supports
 insert match with polar pine door
 door W 15 → centre-to-centre distance 64 mm
 door from W 30 to W 60 → centre-to-centre distance 160 mm
 door W 90 → centre-to-centre distance 320 mm



Maniglia 58RG finitura supporti nichel satinato
 inserto in tinta con anta rovere grigio gessato
 anta L 15 → passo 64 mm
 anta da L 30 a L 60 → passo 160 mm
 anta L 90 → passo 320 mm

Handle 58RG satin nickel finish supports
 insert match with pinstripe grey oak door
 door W 15 → centre-to-centre distance 64 mm
 door from W 30 to W 60 → centre-to-centre distance 160 mm
 door W 90 → centre-to-centre distance 320 mm

SCHEMA MANIGLIA "KL" "KL" HANDLE DIAGRAM



Maniglia KL finitura titanio
passo 32 mm

Handle KL titanium finish
centre-to-centre distance 32 mm



Maniglia KL finitura titanio
Handle KL titanium finish

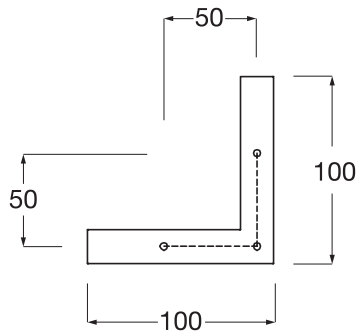
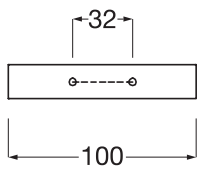

PENSILE / WALL UNIT

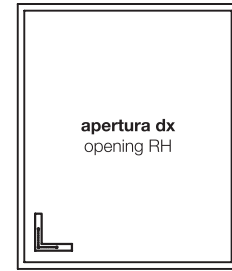
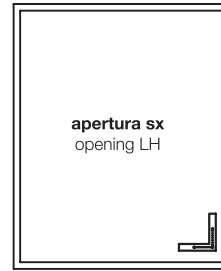

BASE / BASE UNIT

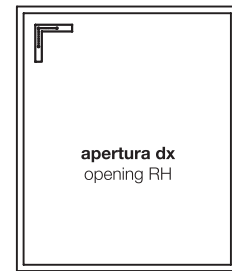

RIBALTA - APERTURA VERTICALE OBLIQUA FLAP DOOR - OBLIQUE VERTICAL OPENING

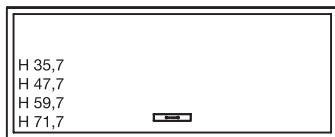

PENSILE WALL UNIT

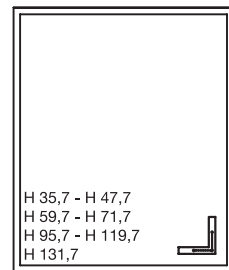

BASE BASE UNIT

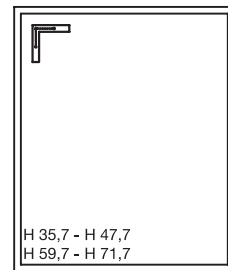

ANTA LAVASTOVIGLIE ANTA CESTELLO ESTRAIBILE DISHWASHER DOOR PULL-OUT BASKET DRAWER DOOR

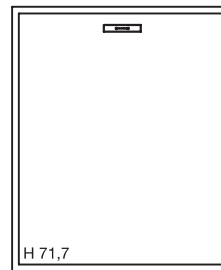

CASSETTO E CESTONE DRAWER AND DEEP DRAWER

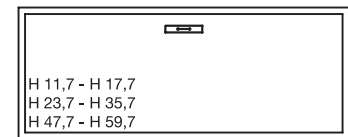

COLONNA 1 ANTA COLUMN DOOR

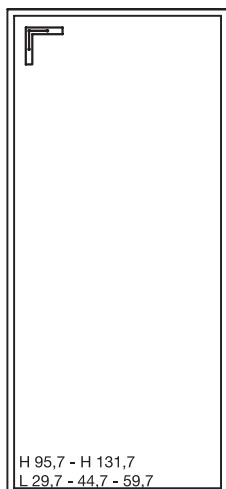

COLONNA ANTA CESTELLO ESTRAIBILE COLUMN PULL-OUT BASKET DRAWER DOOR

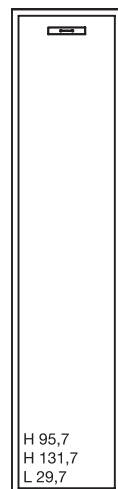

COLONNA MONOPORTA FRIGO - DISPENSA COLUMN SINGLE DOOR FRIDGE - CABINET

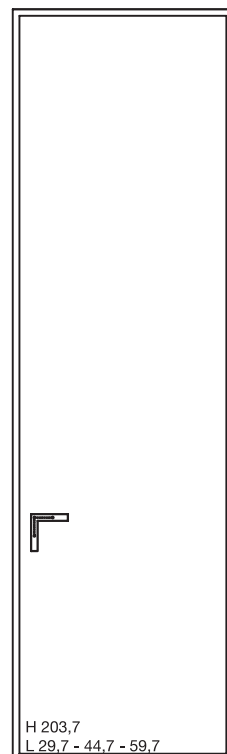

COLONNA ANTA CESTELLO ESTRAIBILE COLUMN PULL-OUT BASKET DRAWER DOOR

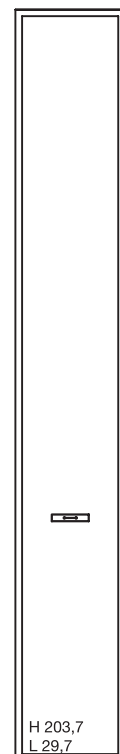

COLONNA FRIGO - DISPENSA COLUMN FRIDGE - CABINET

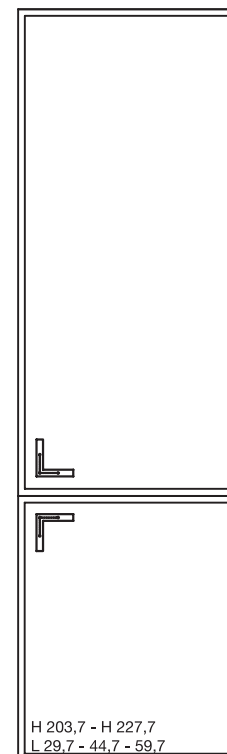

COLONNA FORNO OVEN COLUMN

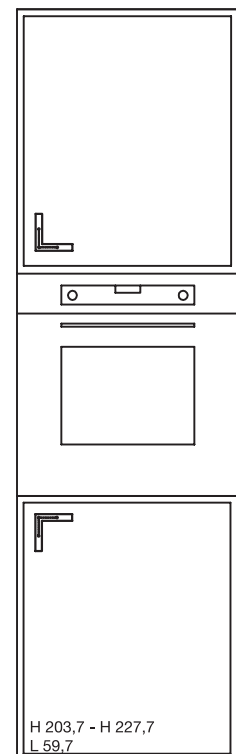

strutture carcasses



bianco (opz.001)
schiena e ripiano bianco
(opz.001)
white (opt.001)
white back panel and shelf
(opt.001)



perla d'oriente (opz.940)
schiena e ripiano bianco
(opz.001)
oriental pearl (opt.940)
white back panel and shelf
(opt.001)



visone (opz.948M)
schiena e ripiano visone
(opz.948M)
mink (opt.948M)
mink back panel and shelf
(opt.948M)



devalè finitura grafis
(opz.796) schiena e ripiano
bianco (opz.001)
devalè with grafis finish
(opt.796)
white back panel and shelf
(opt.001)

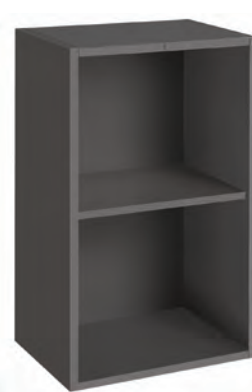

lavagna (opz.9620)
schiena e ripiano lavagna
(opz.9620)
slate grey (opt.9620)
slate grey back panel
and shelf (opt.9620)



fango (opz.8860)
schiena e ripiano fango
(opz.8860)
mud (opt.8860)
mud back panel and shelf
(opt.8860)



CREO ECOLOGIC

IL GRUPPO LUBE HA SCELTO DI UTILIZZARE PER I COMPONENTI COSTITUENTI LE STRUTTURE DELLE CUCINE SOLO MATERIALE A BASSISSIMA EMISSIONE DI FORMALDEIDE: CONFORMI ALLO STANDARD FASTELLE SECONDO LA NORMA JIS, CERTIFICATO DAL MINISTERO GIAPPONESE, IL PIÙ SEVERO IN MERITO ALLE NORMATIVE DI SALVAGUARDIA AMBIENTALE.

LUBE GROUP HAS CHOSEN TO EXCLUSIVELY USE MATERIALS WITH VERY LOW FORMALDEHYDE EMISSIONS FOR THE COMPONENTS MAKING UP THE KITCHEN CARCASSES: THESE ELEMENTS COMPLY WITH THE F4 STAR STANDARD ACCORDING TO JIS, CERTIFIED BY THE JAPANESE GOVERNMENT - THE MOST STRINGENT WHEN IT COMES TO ENVIRONMENTAL PROTECTION.

mensole in nobilitato P 31-61 SP.3,8 come strutture same colours as carcasses melamine coated shelves D 31-61 Th.3,8



bianco (opz.001)
white (opt.001)



perla d'oriente (opz.940)
oriental pearl (opt.940)

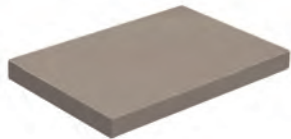

visone (opz.948M)
mink (opt.948M)

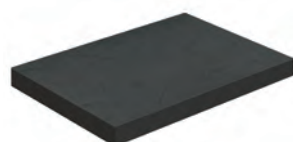

lavagna (opz.9620)
slate grey (opt.9620)

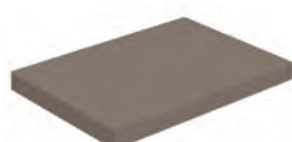

fango (opz.8860)
mud (opt.8860)



devalè finitura grafis (opz.796)
devalè with grafis finish (opt.796)

mensole laccate lacquered shelves



N.B.: disponibili in tutti i colori
opachi della tabella laccati
Creo Kitchens (vedi inserto allegato)

Note: available in all matt colours
on the Creo Kitchens lacquered
colour chart (see insert attached)

mensole in nobilitato P 31-61 SP.3,8 come ante melaminico laminated shelves same as melamine coated doors D 31-61 Th.3,8



frassino creta (opz.2401)
clay ash (opt.2401)



pine cipria (opz.3051)
pale pink pine (opt.3051)



noce brown (opz.2371)
brown walnut (opt.2371)



rovere grigio gessato
(opz.5330)
pinstripe grey oak (opt.5330)



pine polar (opz.3052)
polar pine (opt.3052)

zoccoli in pvc H 13 pvc plinths H 13

di serie
standard



acciaio (opz.407)
steel (opt.407)

zoccoli in alluminio H 13 aluminium plinths H 13



alluminio
finitura brill
(opz.412)
aluminium
brill finish (opt.412)



alluminio finitura titanio
ossidato (opz.414)
aluminium titanium
oxidized finish (opt.414)

al ml
per lm
cod.092125
code

angolare
angular code
cod.0923933

zoccoli in alluminio H 13 verniciati a polvere finitura opaca aluminum plinth height H 13 powder coated matt finish



alluminio finitura
cuoio (opz.8897)
aluminium leather
finish (opt.8897)



alluminio finitura
grigio piombo
(opz.9537)
aluminium lead
grey finish (opt.9537)



alluminio finitura
nocciola (opz.7775)
aluminium hazel
finish (opt.7775)



alluminio finitura
canapa (opz.8531)
aluminium hemp
finish (opt.8531)

al ml
per lm
cod.092125
code

angolare
angular code
cod.0923933



alluminio finitura
platino (opz.7773)
aluminium platinum
finish (opt.7773)



alluminio finitura
polvere (opz.9539)
aluminium dust
finish (opt.9539)



alluminio finitura
bianco assoluto
(opz.740S)
aluminium absolute
white finish (opt.740S)



alluminio finitura
bianco caldo
(opz.7401)
aluminium warm
white finish (opt.7401)



alluminio finitura
blu fiordaliso
(opz.8377)
aluminium cornflower
blue finish (opt.8377)



alluminio finitura
grigio bromo
(opz.9533)
aluminium bromine
grey finish (opt.9533)



alluminio finitura
nero (opz.7892)
aluminium
black finish
(opt.7892)



alluminio finitura
terra di siena
(opz.8161)
aluminium siena
earth finish
(opt.8161)



alluminio finitura
castoro (opz.8907)
aluminium beaver
finish (opt.8907)



alluminio finitura
fumo (opz.9531)
aluminium smoke
finish (opt.9531)



alluminio finitura
giallo ambra
(opz.8225)
aluminium amber
yellow finish (opt.8225)



alluminio finitura
rosso toscano
(opz.8157)
aluminium tuscan
red finish (opt.8157)



alluminio finitura
verde positano
(opz.8471)
aluminium positano
green finish (opt.8471)

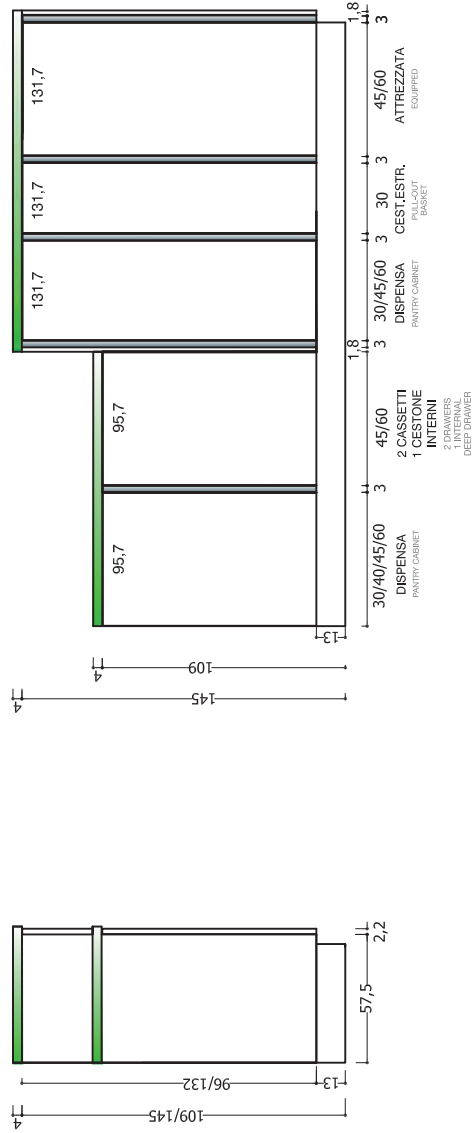

COLONNE
COLUMNS

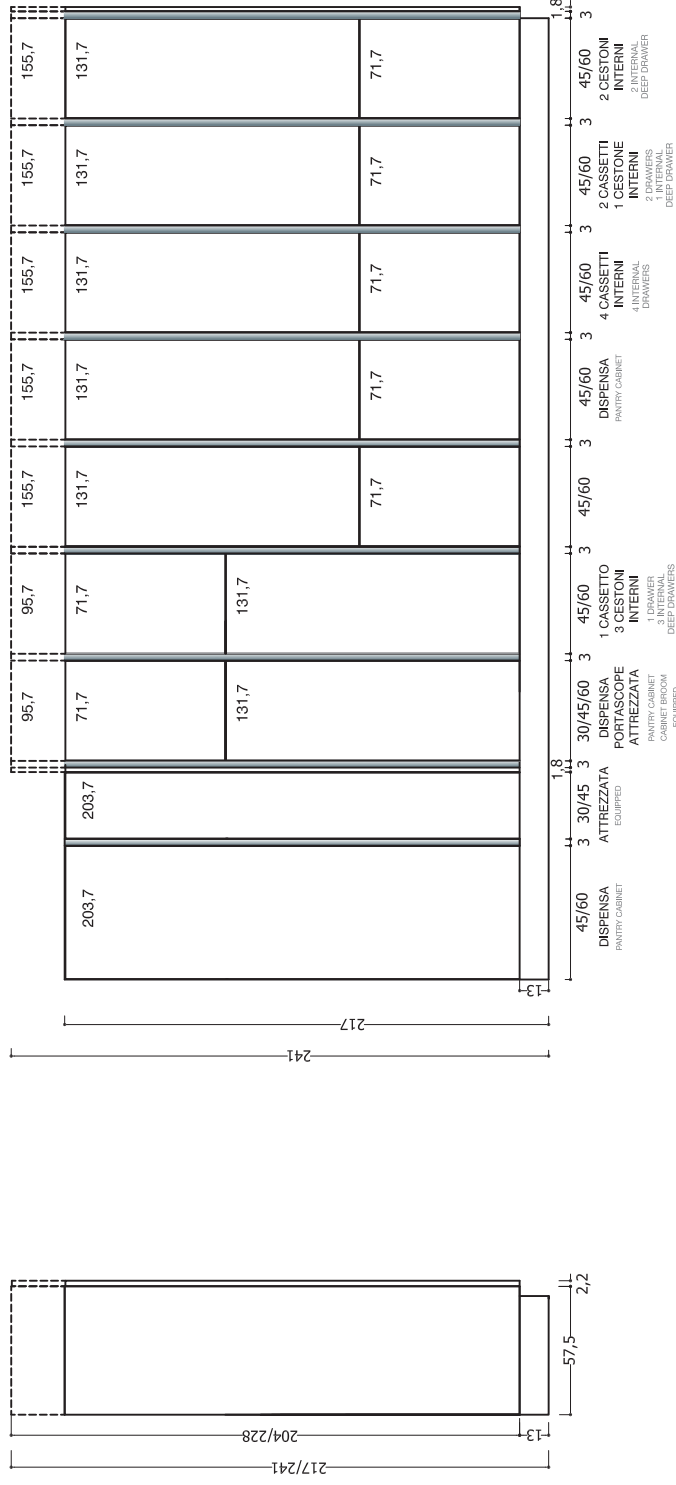

MODULARITÀ E COMPONENTIBILITÀ MODULARITY AND FITTING SOLUTIONS

COLONNE FRIGO

FRIDGE COLUMNS

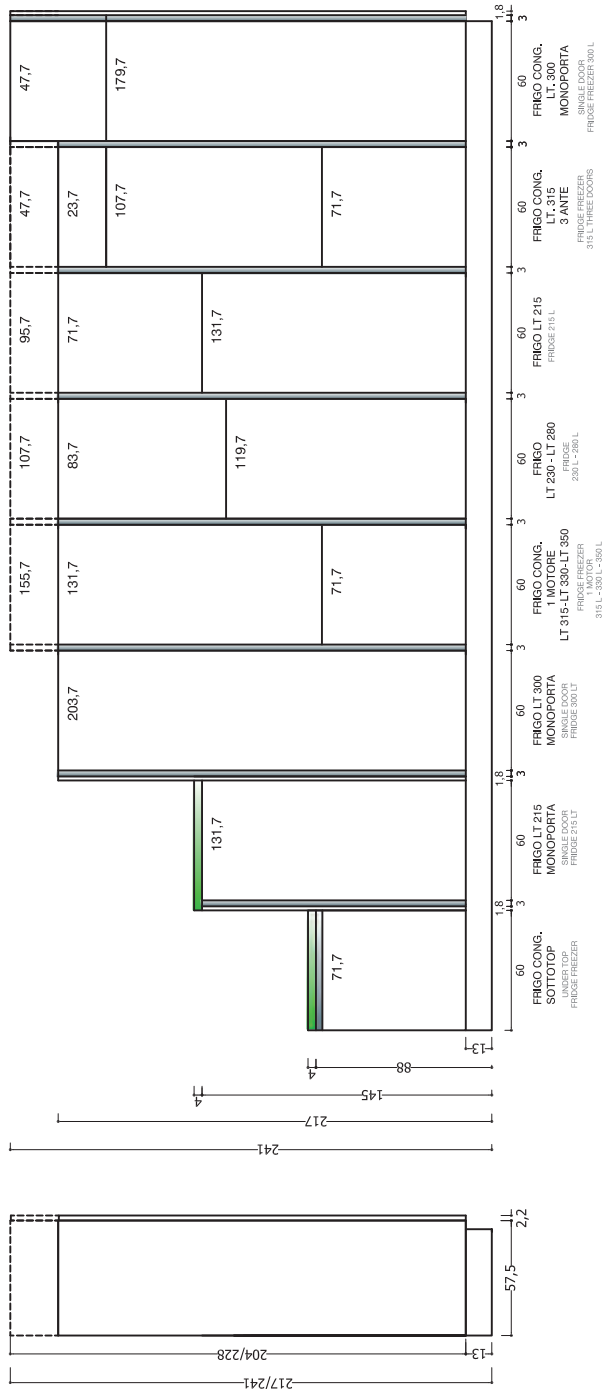

COLONNE FORNO

OVEN COLUMNS

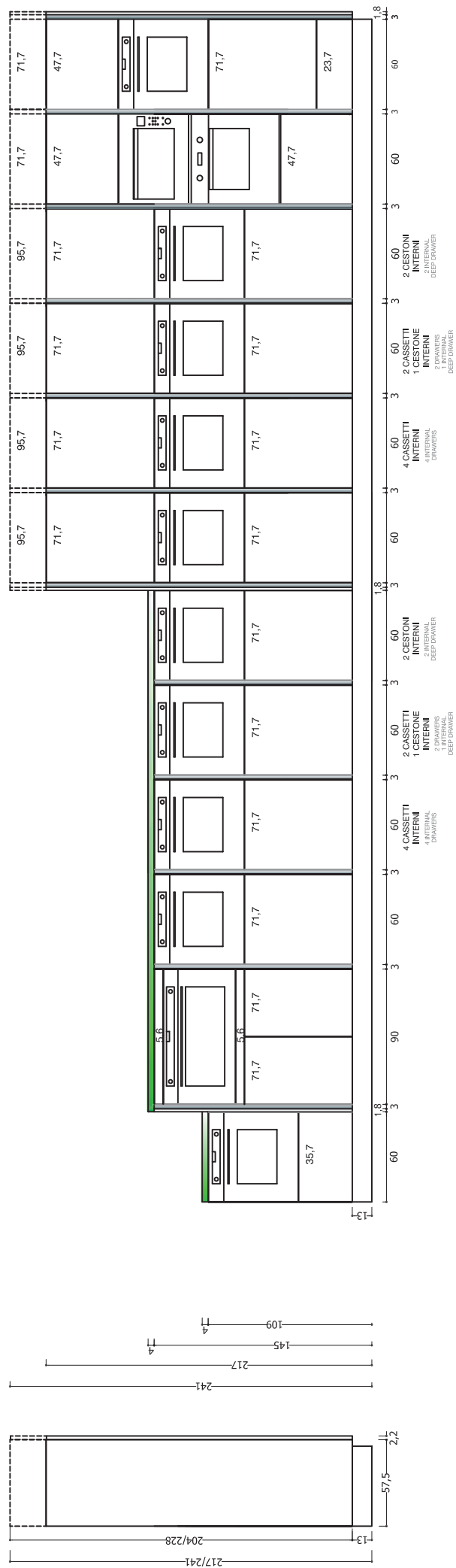



MODULARITÀ E COMPONIBILITÀ MODULARITY AND FITTING SOLUTIONS

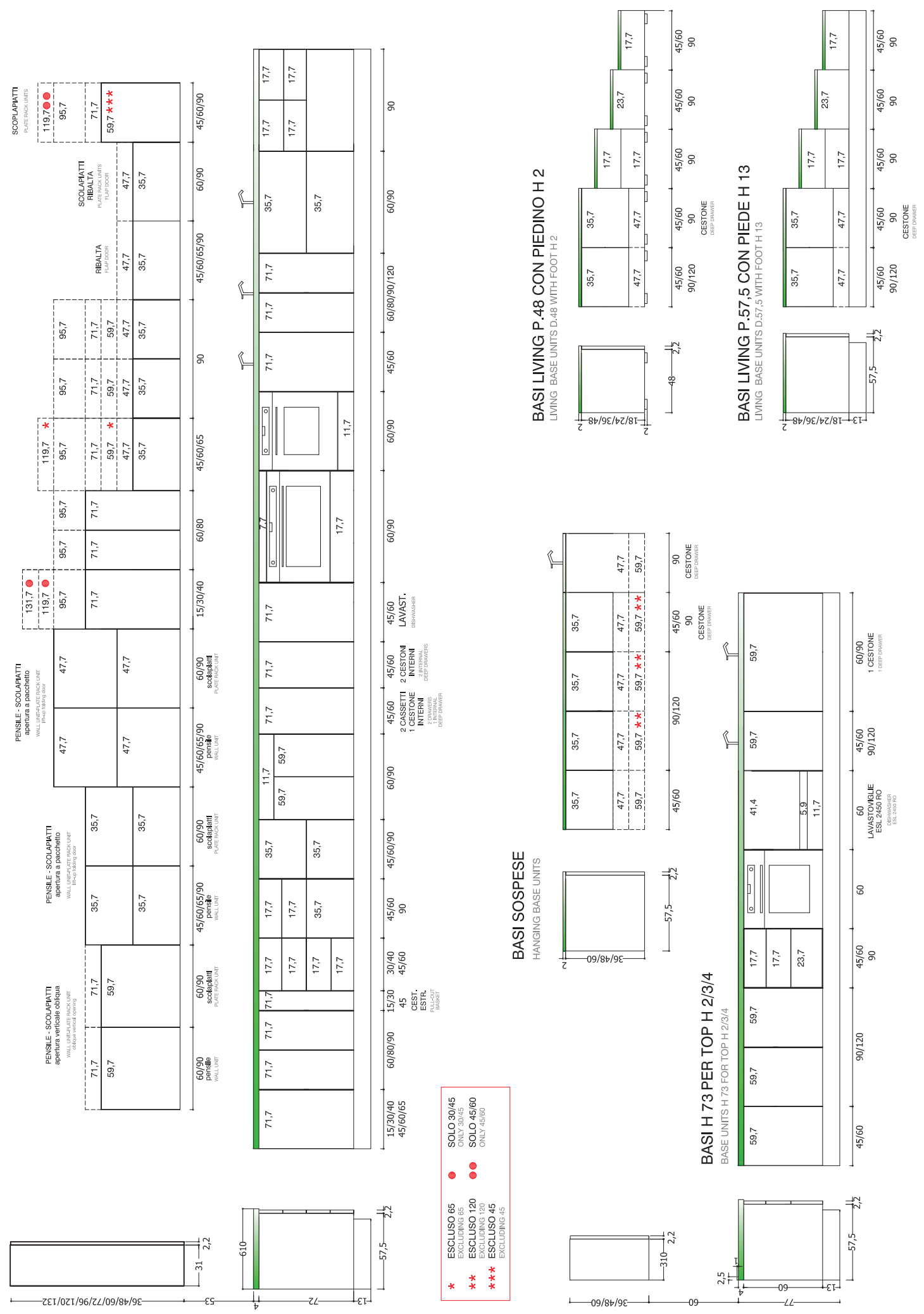

MODULARITÀ E COMPONENTABILITÀ MODULARITÀ AND FITTING SOLUTIONS

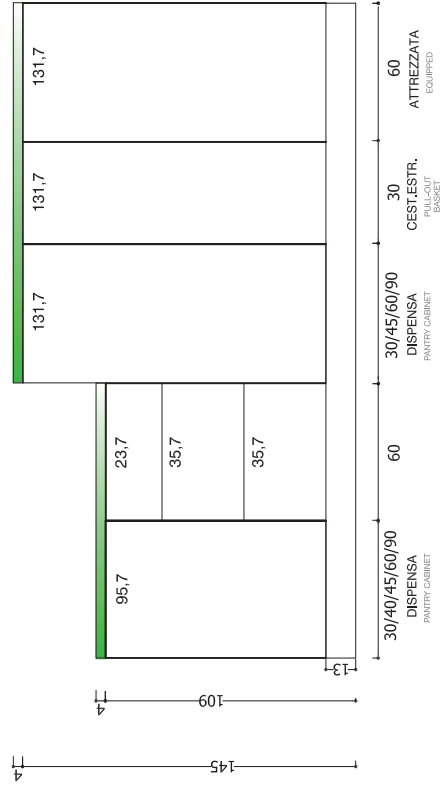
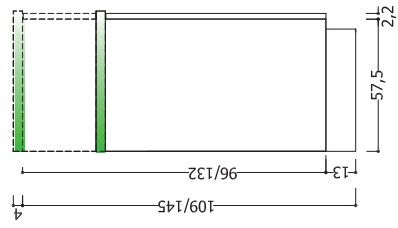

COLONNE COLUMNS

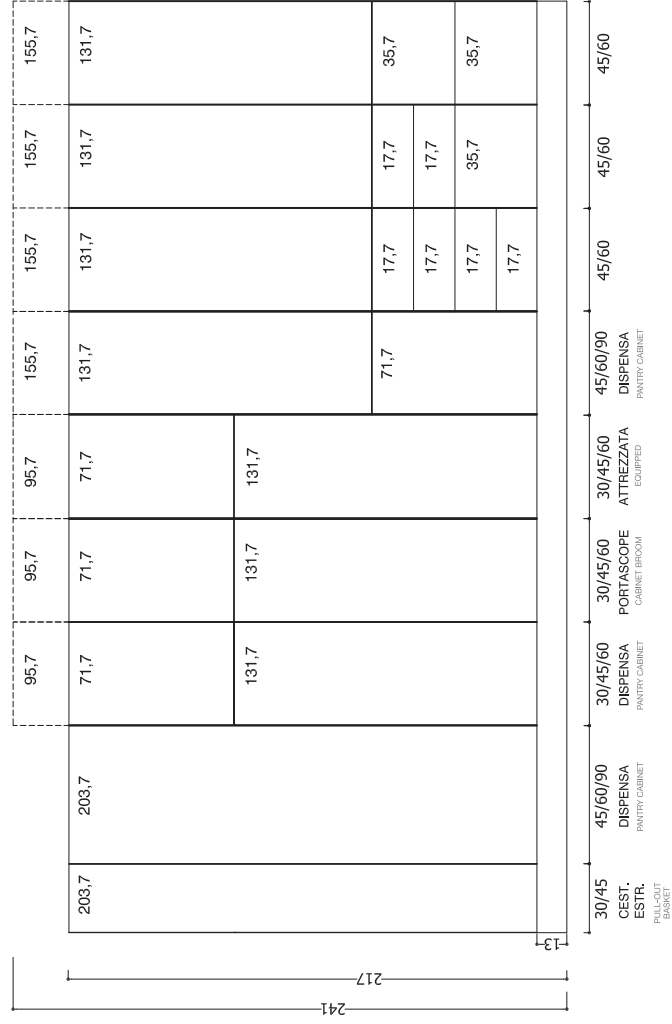
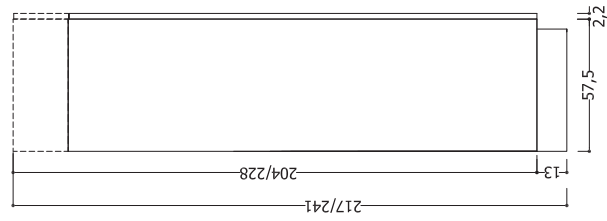

PENSILE CON APERTURA A RIBALTA

Le ante aprendosi verso l'alto consentono di avere un' ampia visione d'insieme all'interno del mobile. In questo modo è possibile un comodo accesso agli oggetti contenuti al suo interno e, dal punto di vista ergonomico, molto vantaggioso. La regolazione della forza di apertura può essere impostata in modo esatto in base al peso del frontale. Grazie all'arresto progressivo le ante si fermano in qualsiasi posizione; in questo modo la maniglia è sempre facilmente raggiungibile. La chiusura è ammortizzata di serie.

WALL UNIT WITH FLAP DOOR

The doors that open upwards guarantee ample overall visibility inside the cabinet. In this way, all objects housed inside the cabinet can be comfortably accessed, making the system highly advantageous from an ergonomic perspective. The opening force can be adjusted precisely according to the weight of the front. The doors stop in any position thanks to the gradual stopping movement; in this way, the handle is always easily accessible. The closing movement is cushioned standard

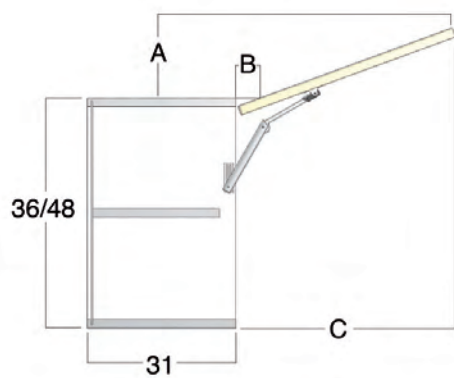

	A	B	C
H 36	7	4	37
H 48	11	4	49



Grazie al meccanismo TIP-ON, le ante a ribalta senza maniglia possono essere aperte semplicemente con un leggero tocco. Per chiudere l'anta a ribalta, è sufficiente esercitare una leggera pressione, che grazie ad una piastrina di bloccaggio, applicata sul lato interno del frontale, ne assicura la perfetta chiusura.

Thanks to TIP-ON mechanism, the flap doors without handles can be opened with a simple touch. To close the flap door, just exercise light pressure, thanks to the locking plate, applied on the inner side of the front panel ensures a perfect closure.

APERTURA VERTICALE OBLIQUA

I pensili con questo tipo di meccanismo necessitano per l'apertura di poco spazio libero sopra il mobile grazie al movimento basculante dell'anta che si apre senza difficoltà applicando poca forza anche in presenza di frontali pesanti. Con l'arresto progressivo le ante si fermano in qualsiasi posizione; in questo modo la maniglia è sempre facilmente raggiungibile. La chiusura è ammortizzata ed è possibile regolare la forza di tenuta in base al peso del frontale.

VERTICAL OPENING OBLIQUE

Wall units that mount this type of mechanism require little clearance above the cabinet thanks to the swivelling movement of the door that can be easily opened by applying slight pressure, even with heavy fronts. The doors stop in any position thanks to the gradual stopping movement; in this way, the handle is always easily accessible. The closing movement is cushioned and the closing force can be adjusted according to the weight of the front door.

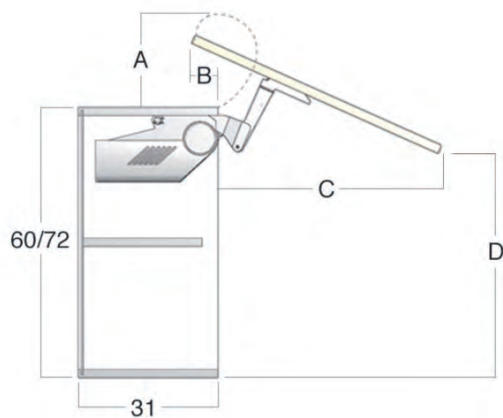

	A	B	C	D
H 60	18	9,6	46,5	53,5
H 72	18	9,6	57	61

PENSILE CON APERTURA ANTE A PACCHETTO

Il meccanismo d'apertura ante a pacchetto è idoneo sia sul pensile H 72 che H 96; la regolazione della forza di apertura può essere impostata in modo esatto in base ai pesi dei frontali, la chiusura è ammortizzata e la cerniera centrale clip si contraddistingue per l'innovativa tecnologia che garantisce la sicurezza per le dita.

WALL UNIT WITH LIFT-UP FOLDING DOORS

The lift-up folding door opening mechanism is suitable for wall units with H 72 or H 96; the opening force can be adjusted precisely according to the weight of the fronts, while the closing movement is cushioned and the central clip-on hinge features innovative technology for safeguarding the fingers.



H 72



H 96

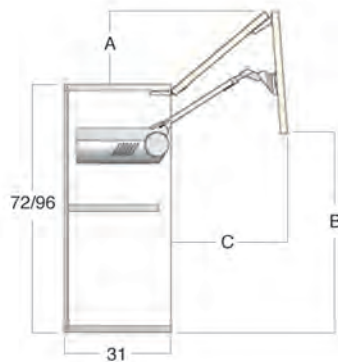

	A	B	C
H 72	16,5	54	41
H 96	20	69	53

**SCHEMA MONTAGGIO
LIMITATORE
LIMITER INSTALLATION
DIAGRAM**

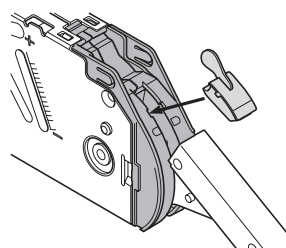
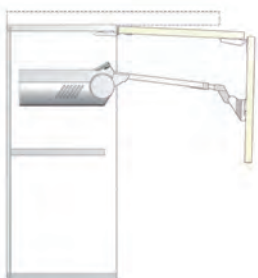

Per evitare l'interferenza dell'anta in fase di apertura con cornici o mensole, si può richiedere il limitatore dell'angolo di apertura cod. 5620005

In order to avoid that the door interferes with cornices or shelves during the opening movement, it is possible to request an opening angle limiter: code 5620005



COMPOSIZIONE CON ELEMENTI INCLINATI

COMPOSITION WITH INCLINED ELEMENTS

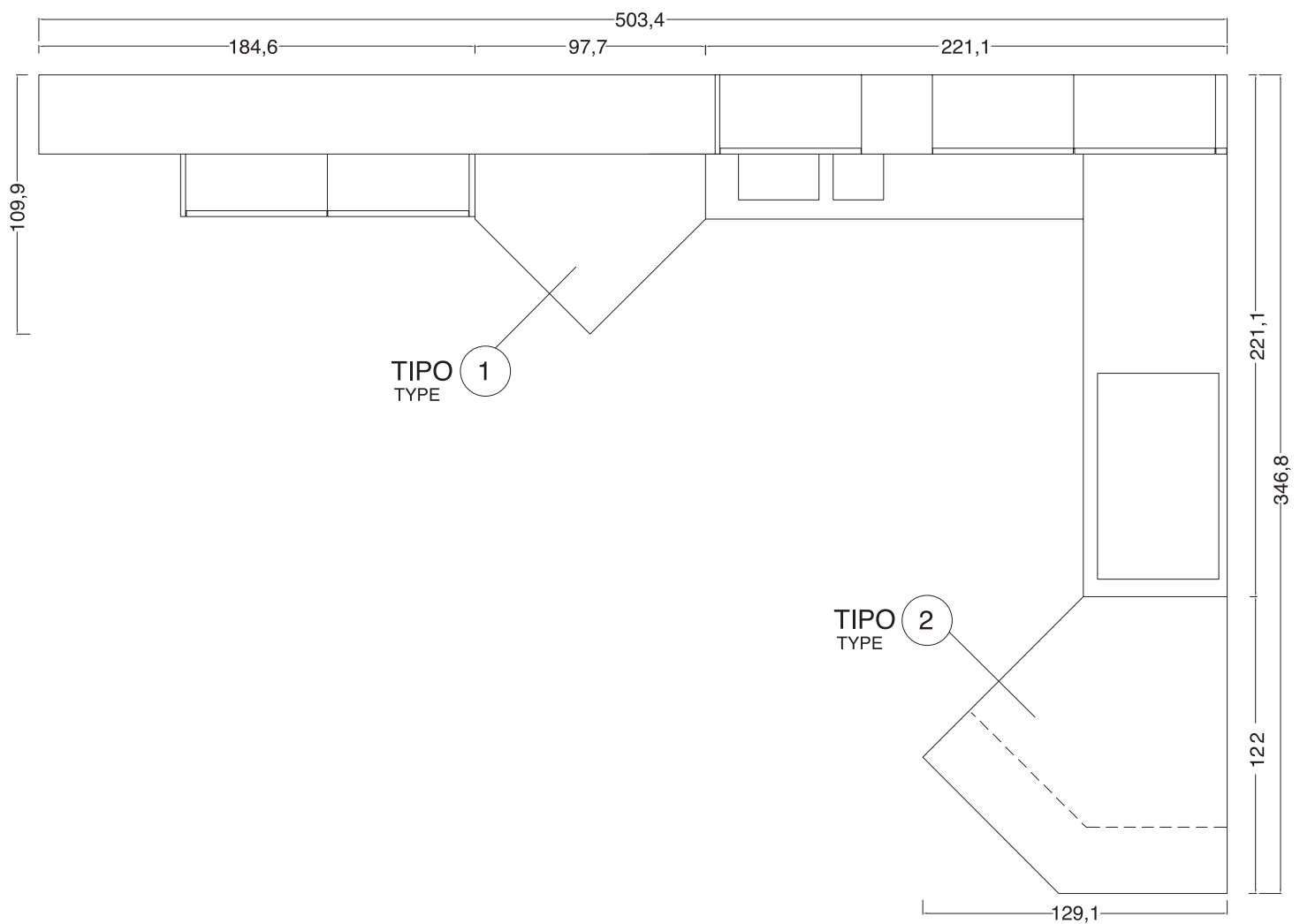
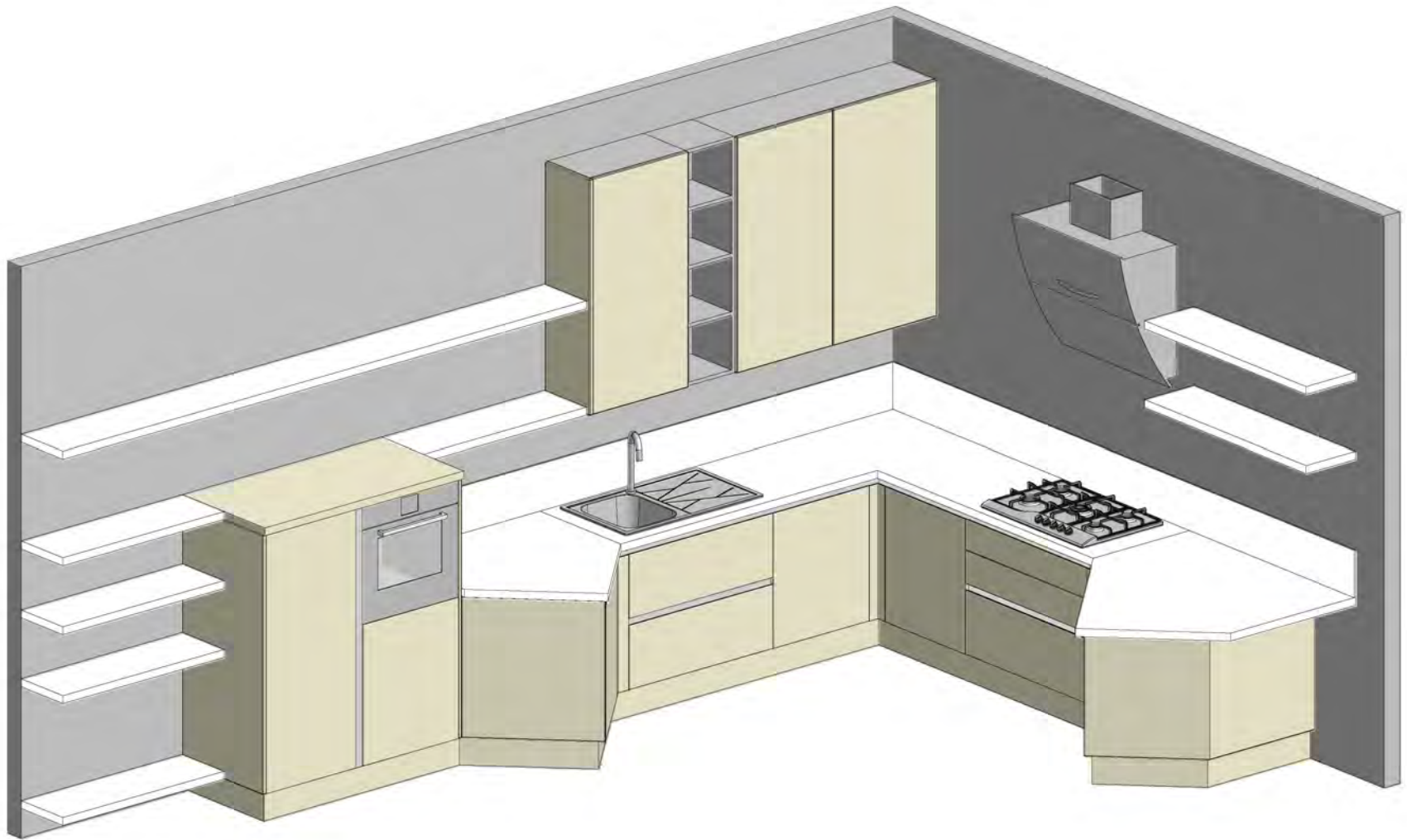



GOLE PER COLONNE

COLUMNS FINGER RAILS

NELLE COLONNE PER L'APERTURA DELLE ANTE E' OBBLIGATORIO L'INSERIMENTO DELLE GOLE VERTICALI
VERTICAL FINGER RAILS MUST BE FITTED TO COLUMNS WITH OPENING DOORS

COD.

mezza gola elle verticale tipo "C"
 elle half finger rail type "C"

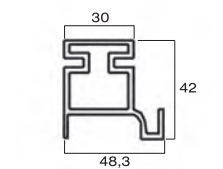

Sezione gola tipo "C"
 Type "C" finger rail section

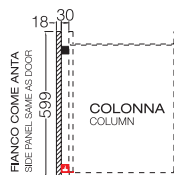

***gola con fianco come anta montato**
 *finger rail mounted on side panel same as door

gola
 finger rail

H 96

G950310

H 132

G950330

H 204

G950350

H 228

G950370

H 96

G950319

H 132

G950339

H 204

G950359

H 228

G950379

gola elle verticale intermedia tipo "D"
 elle vertical intermediate finger rail type "D"

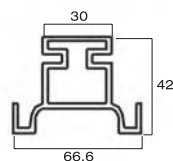

Sezione gola tipo "D"
 Type "D" finger rail section

gola
 finger rail

H 96

G950410

H 132

G950430

H 204

G950450

H 228

G950470

gola elle verticale laterale tipo "E"
 elle vertical lateral finger rail type "E"

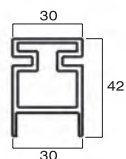

Sezione gola tipo "E"
 Type "E" finger rail section

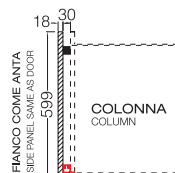

***gola con fianco come anta montato**
 *finger rail mounted on side panel same as door

gola
 finger rail

H 96

G950510

H 132

G950530

H 204

G950550

H 228

G950570

H 96

G950519

H 132

G950539

H 204

G950559

H 228

G950579





Grazie al meccanismo TIP-ON, le ante a ribalta senza maniglia possono essere aperte semplicemente con un leggero tocco. Per chiudere l'anta a ribalta, è sufficiente esercitare una leggera pressione, che grazie ad una piastrina di bloccaggio, applicata sul lato interno del frontale, ne assicura la perfetta chiusura.

Thanks to TIP-ON mechanism, the flap doors without handles can be opened with a simple touch. To close the flap door, just exercise light pressure, thanks to the locking plate, applied on the inner side of the front panel ensures a perfect closure.

COMPOSIZIONE CON ELEMENTI INCLINATI



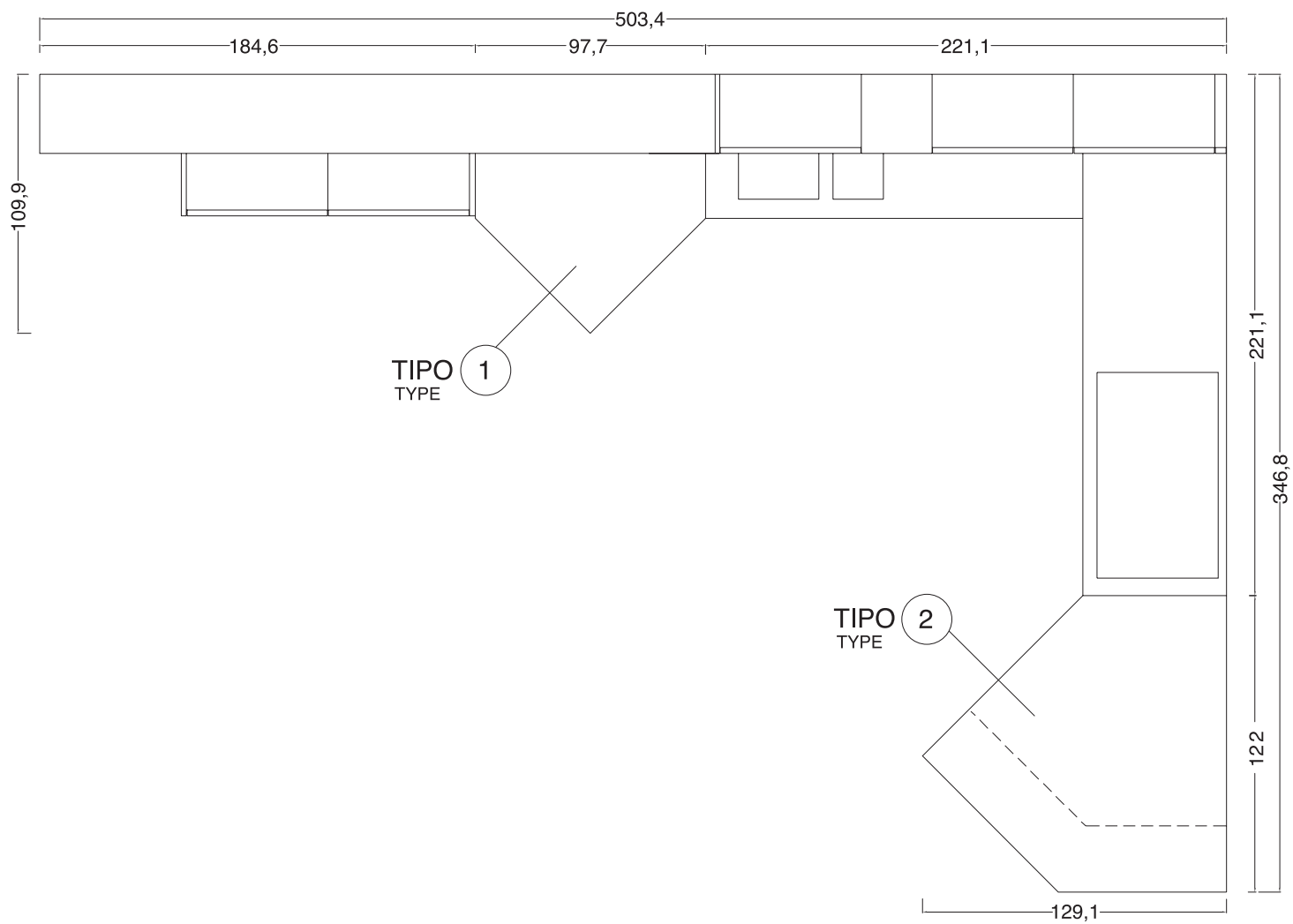
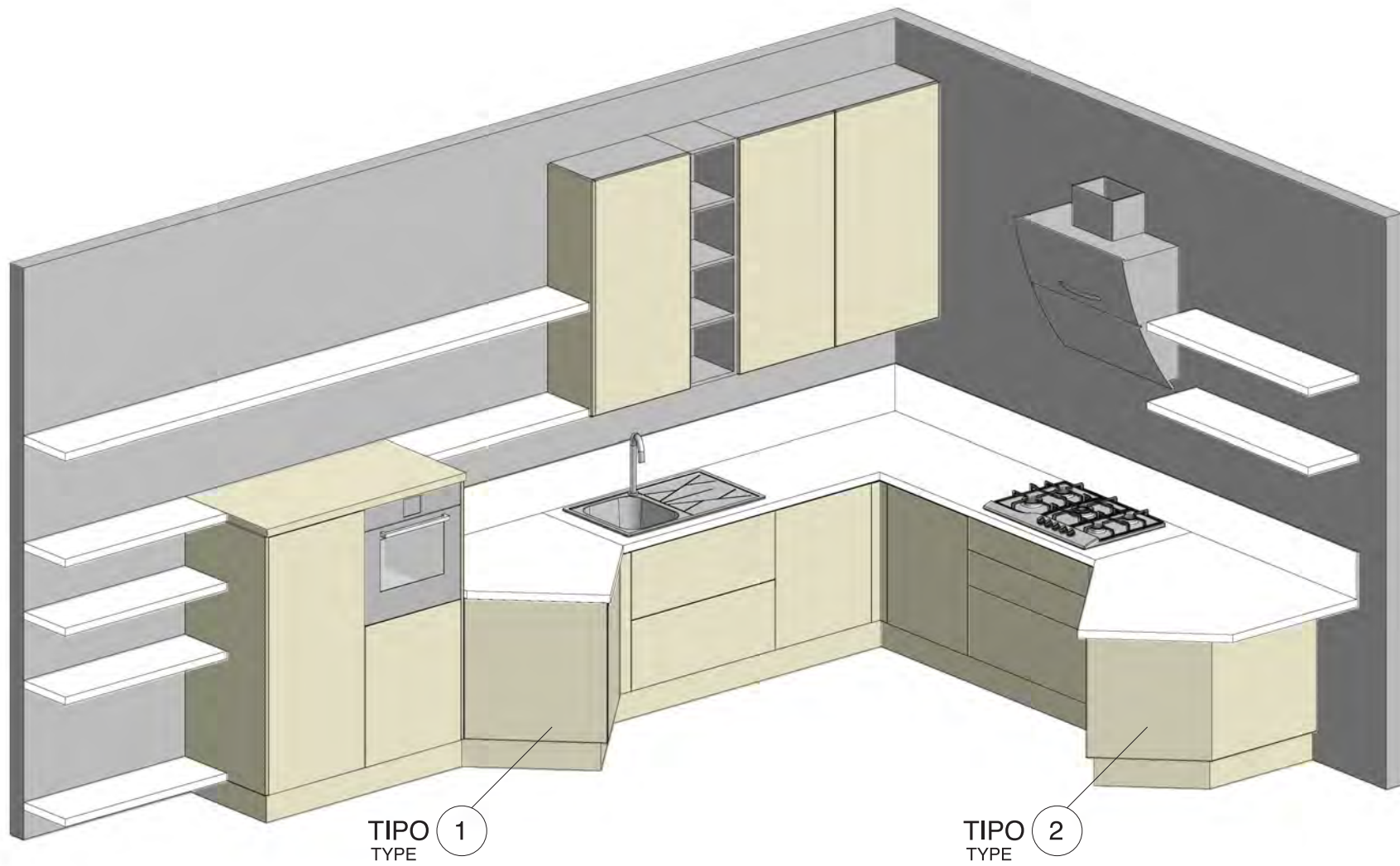







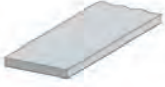





COMPOSITION WITH INCLINED ELEMENTS



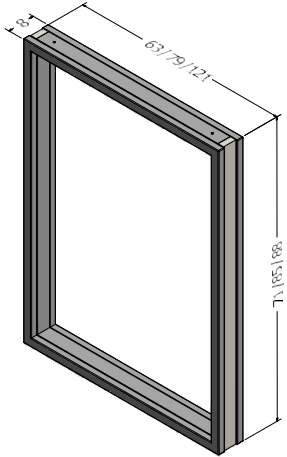
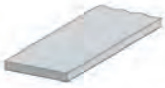

MENSOLE E ACCESSORI

SHELVES AND ACCESSORIES

	COD.			COD.		
<p>mensola sp. 3,8 in laminato L max cm 400 laminate shelf Th. 3,8 Max. length 400 cm</p>  <div style="display: flex; justify-content: space-around;"> <div style="text-align: center;">  bianco (opz.001) white </div> <div style="text-align: center;">  perla d'oriente (opz.940) oriental pearl </div> <div style="text-align: center;">  devalè finitura grafis (opz.796) devalè with grafis finish </div> </div> <div style="display: flex; justify-content: space-around; margin-top: 10px;"> <div style="text-align: center;">  visone (opz.948M) mink </div> <div style="text-align: center;">  lavagna (opz.9620) slate grey </div> <div style="text-align: center;">  fango (opz.8860) mud </div> </div>				<p>sostegno con struttura in metallo titanio o brill e inserti in melaminico o laccato come ante support with titanium or brill metal structure and melamine or lacquered insert, same colour as door</p> 		
	P 31	091523				
	P 61	091560				
<p>mensola sp. 3,8 in melaminico finitura come ante, L max cm 275 melamine shelf Th. 3,8 same finish as door Max. length 275 cm</p>  <div style="display: flex; justify-content: space-around;"> <div style="text-align: center;">  frassino creta (opz.2401) clay ash </div> <div style="text-align: center;">  pine cipria (opz.3051) pale pink pine </div> <div style="text-align: center;">  noce brown (opz.2371) brown walnut </div> </div> <div style="display: flex; justify-content: space-around; margin-top: 10px;"> <div style="text-align: center;">  rovere grigio gessato (opz.5330) pinstripe grey oak </div> <div style="text-align: center;">  pine polar (opz.3052) polar pine </div> </div>						
	P 31	091523				
	P 61	091560				
<p>mensola sp. 3,8 laccata come ante, L max cm 300 N.B.: disponibili in tutti i colori opachi della tabella laccati shelf Th. 3.8 lacquered same as door, max. length 300 cm <i>Note: available in all matt colours on the colour chart</i></p> 						
<p> CLICCA QUI PER LA GAMMA COLORI DISPONIBILI</p>						
<p> CLICK HERE FOR THE RANGE OF AVAILABLE COLORS</p>						
	P 31	091733				
	P 61	091736				
					brill	
					H 71 L 63	08790250
					L 79	08790251
					L 121	08790252
					H 85 L 63	08790255
					L 79	08790256
					L 121	08790257
					H 88 L 63	08790260
					L 79	08790261
					L 121	08790262
					titanio titanium	
					H 71 L 63	08790270
					L 79	08790271
					L 121	08790272
					H 85 L 63	08790275
					L 79	08790276
					L 121	08790277
					H 88 L 63	08790280
					L 79	08790281
					L 121	08790282

TERMINALI A GIORNO

OPEN END UNITS



LIVING

Spazi coordinati per avere un solo ambiente per cucinare, ricevere gli amici, pranzare e rilassarsi è una soluzione al desiderio di vivere la casa più liberamente, secondo stili di vita contemporanei, integrando cucina e living all'insegna di un nuovo linguaggio progettuale.

Coordinated spaces that create a single environment in which to cook, receive friends and relax is a solution that allows you to experience the home more freely.

In line with contemporary lifestyles, this solution integrates the kitchen and living area to create a new design language



LIVING KRW-1



ANTE
doors



ELEMENTI A GIORNO
open units



STRUTTURE
carcasses

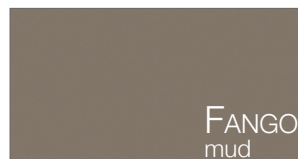

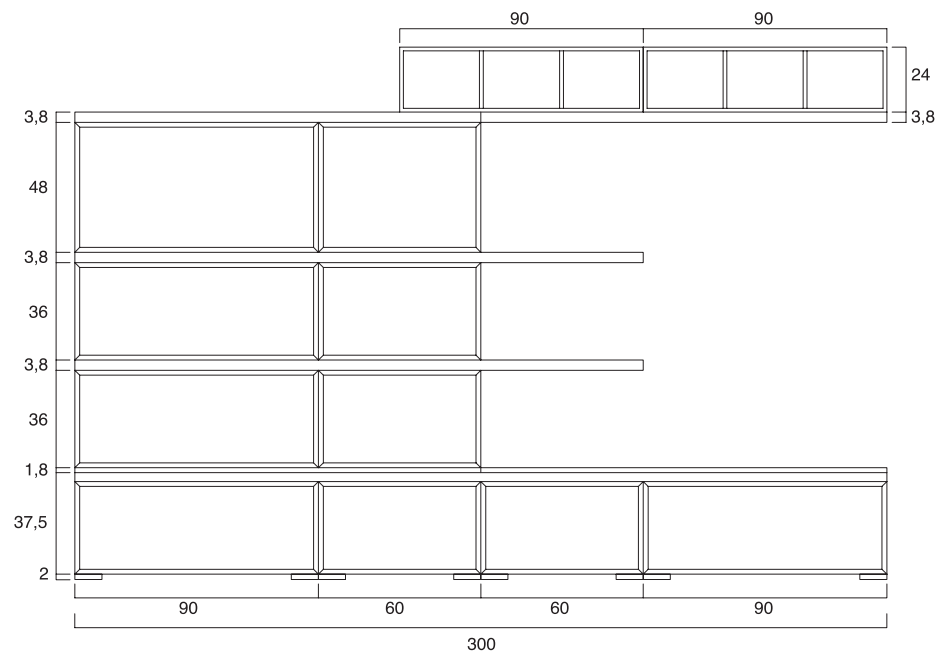

NR. ELEMENTI	DESCRIZIONE	CODICE
1	Pensile L 90 H 48 P 33,4 ribalta apertura tip-on	G212091T
1	Pensile L 60 H 48 P 33,4 ribalta apertura tip-on	G212061T
1	Coprifianco H 48 P 31 laccato come anta	T98345
2	Pensile L 90 H 36 P 33,4 apertura vasistas	G2106900
2	Pensile L 60 H 36 P 33,4 apertura vasistas	G2106600
2	Coprifianco H 36 P 31 laccato come anta	T98340
1	Base living L 90 H 39,5 P 50,4, 1 cestone	GBL25900
2	Base living L 60 H 39,5 P 50,4, 1 cestone	GBL25600
1	Base living L 90 H 39,5 P 50,4, 1 cestone, 1 fianco come anta	GBL25900
2	Elemento a giorno L 90 H 24 P 31, 3 vani laccato opaco	E7701707
2	Mensola melaminico L 150 P 33,4 SP. 3,8 colore come anta	al ml 091527
2	Mensola melaminico L 210 P 33,4 SP. 3,8 colore come anta	al ml 091527
2	Top melaminico L 150 P 50,4 SP. 1,8 colore come anta	al ml TLE187
3	Asta appendipensili ml 2	08610501

No. of ELEMENTS	DESCRIPTION	CODE
1	Wall unit W 90 H 48 D 33,4 flap door, tip-on opening	G212091T
1	Wall unit W 60 H 48 D 33,4 flap door, tip-on opening	G212061T
1	Lacquered side panel H 48 D 31 same colour as door	T98345
2	Wall unit W 90 H 36 D 33,4 flap door opening	G2106900
2	Wall unit W 60 H 36 D 33,4 flap door opening	G2106600
2	Lacquered side panel H 36 D 31 same colour as door	T98340
1	Living base unit W 90 H 39,5 D 50,4, 1 deep drawer	GBL25900
2	Living base unit W 60 H 39,5 D 50,4, 1 deep drawer	GBL25600
1	Living base unit W 90 H 39,5 D 50,4, 1 deep drawer, 1 side same as door	GBL25900
2	Matt lacquered open unit W 90 H 24 D 31, 3 compartments	E7701707
2	Melamine shelf W 150 D 33,4 TH. 3,8 same colour as door	per lm 091527
2	Melamine shelf W 210 D 33,4 TH. 3,8 same colour as door	per lm 091527
2	Melamine worktop W 150 D 50,4 TH. 1,8 same colour as door	per lm TLE187
3	Wall unit fixing strip lm 2	per lm 08610501

LIVING KRW-2



ANTE
doors

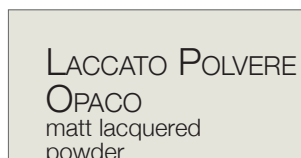

ANTA VETRO
glass door

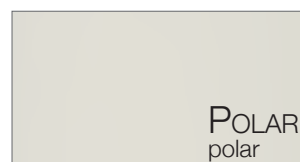

STRUTTURE
carcasses

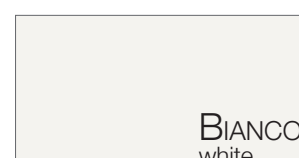

LIVING KRW-2

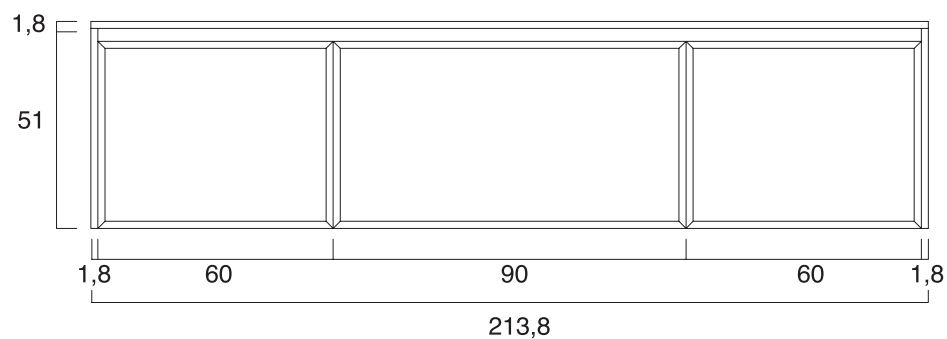
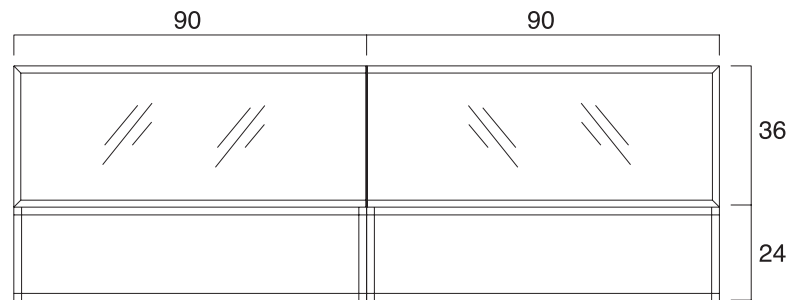

NR. ELEMENTI	DESCRIZIONE	CODICE
2	Pensile vetro telaio alluminio L 90 H 36 P 33,4 ribalta tip-on, fianco come anta	G110291T
2	Elemento a giorno alluminio L 90 H 24 P 31, ripiani in vetro	E7861090
2	Base living sospesa L 60 H 51 P 50,4 1 cestone	GBL85600
1	Base living sospesa L 90 H 51 P 50,4 1 cestone	GBL85900
1	Top melaminico L 213,8 P 50,4 SP. 1,8 colore come anta	al ml TLE187
2	Fianco melaminico H 51 P 50,4 SP. 1,8 colore come anta	al ml TLE187F
2	Asta appendipensili ml 2	08610501

No. of ELEMENTS	DESCRIPTION	CODE
2	Glass door wall unit with aluminium frame W 90 H 36 D 33,4, flap door with tip-on opening, side same as door	G110291T
2	Aluminium open element W 90 H 24 D 31 with glass shelves	E7861090
2	Hanging living base unit W 60 H 51 D 50,4 1 deep drawer	GBL85600
1	Hanging living base unit W 90 H 51 D 50,4 1 deep drawer	GBL85900
1	Melamine worktop W 213,8 D 50,4 TH. 1,8 same colour as door	per lm TLE187
2	Melamine side panel H 51 D 50,4 TH. 1,8 same colour as door	per lm TLE187F
2	Wall unit fixing strip mt. 2	08610501

LIVING KRW-3



ANTA
door

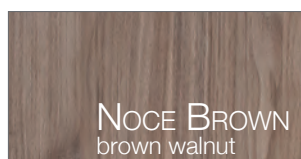

ANTA VETRO
glass door

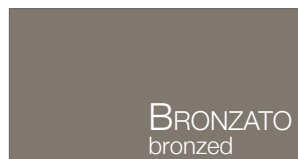

ELEMENTI A GIORNO
open units



STRUTTURE
carcasses

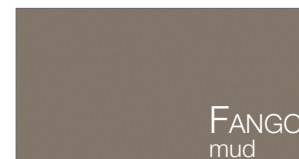

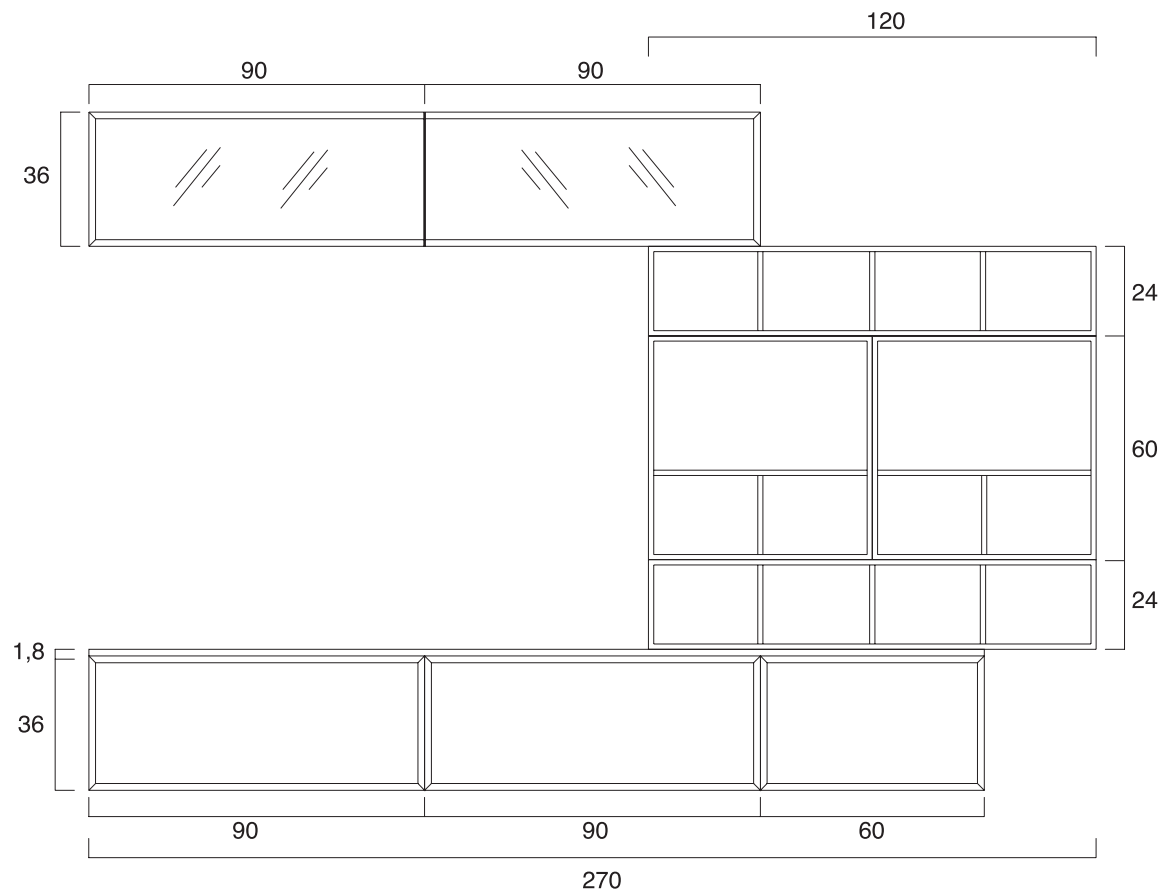

NR. ELEMENTI	DESCRIZIONE	CODICE
2	Pensile vetro telaio alluminio L 90 H 36 P 33,4 ribalta tip-on, 1 fianco come anta	G110291T
1	Base living sospesa L 90 H 36 P 50,4, 1 cestone apertura tip-on, 1 fianco come anta	EBL75900
1	Base living sospesa L 90 H 36 P 50,4, 1 cestone apertura tip-on	EBL75900
1	Base living sospesa L 60 H 36 P 50,4, 1 cestone apertura tip-on, 1 fianco come anta	EBL75600
2	Elemento a giorno L 120 H 24 P 31 4 vani, laccato opaco	E7701708
2	Elemento a giorno L 60 H 60 P 31 3 vani, laccato opaco	E7701720
1	Top melaminico L 240 P 50,4 SP. 1,8 colore come anta	al ml TLE187
1	Asta appendipensili ml 2	08610501
No. of ELEMENTS	DESCRIPTION	CODE
2	Glass door wall unit with aluminium frame W 90 H 36 D 33,4 flap door tip-on opening, 1 side same colour as door	G110291T
1	Hanging living base unit W 90 H 36 D 50,4, 1 deep drawer tip-on opening, 1 side same colour as door	EBL75900
1	Hanging living base unit W 90 H 36 D 50,4, 1 deep drawer tip-on opening	EBL75900
1	Hanging living base unit W 60 H 36 D 50,4, 1 deep drawer tip-on opening, 1 side same colour as door	EBL75600
2	Matt lacquered open element W 120 H 24 D 31, 4 compartments	E7701708
2	Matt lacquered open element W 60 H 60 D 31, 3 compartments	E7701720
1	Melamine worktop W 240 D 50,4 TH. 1,8 same colour as door	per lm TLE187
1	Wall unit fixing strip lm 2	08610501

LIVING KRW-4



ANTA
door

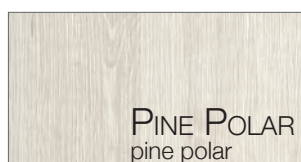

ELEMENTI A GIORNO
open units



STRUTTURE
carcasses

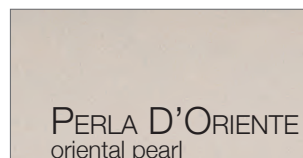

LIVING KRW-4

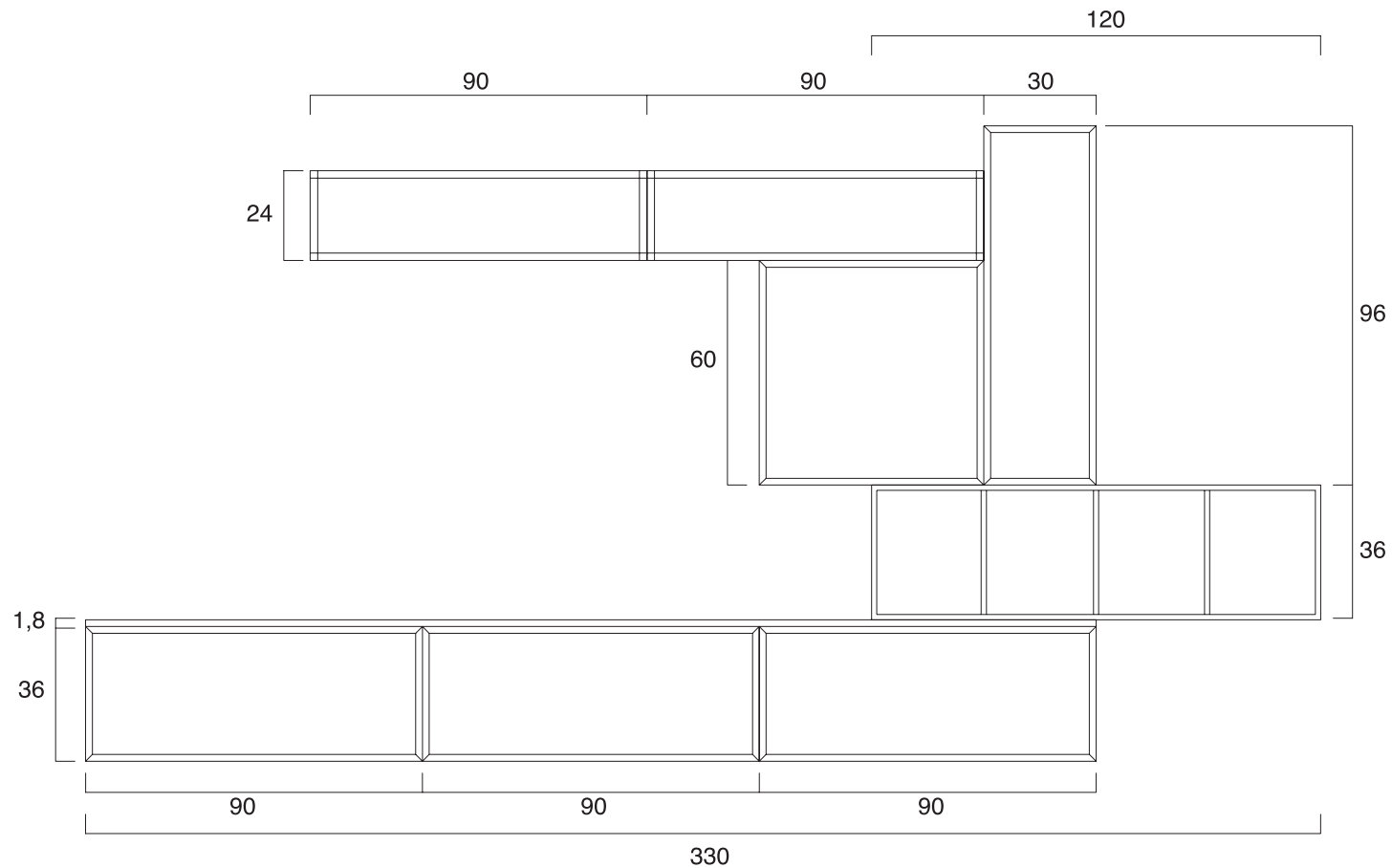

NR. ELEMENTI	DESCRIZIONE	CODICE
2	Elemento a giorno alluminio L 90 H 24 P 31, ripiani in vetro	E7861090
1	Pensile L 60 H 60 P 33,4 apertura push-pull, 1 fianco come anta	E2060601/2
1	Pensile L 30 H 96 P 33,4 apertura push-pull, 2 fianchi come anta	E2020301/2
1	Elemento a giorno L 120 H 36 P 31, 4 vani, laccato opaco	E7701713
2	Base living sospesa L 90 H 36 P 50,4, 1 cestone apertura tip-on, 1 fianco come anta	EBL75900
1	Base living sospesa L 90 H 36 P 50,4, 1 cestone apertura tip-on	EBL75900
1	Top melaminico L 270 P 50,4 SP. 1,8 colore come anta	al ml TLE187
2	Asta appendipensili ml 2	08610501
No. of ELEMENTS	DESCRIPTION	CODE
2	Aluminium open element W 90 H 24 D 31 with glass shelves	E7861090
1	Wall unit W 60 H 60 D 33,4 push-pull opening, 1 side same colour as door	E2060601/2
1	Wall unit W 30 H 96 D 33,4 push-pull opening, 2 sides same colour as door	E2020301/2
1	Matt lacquered open element W 120 H 36 D 31, 4 compartments	E7701713
2	Hanging living base unit W 90 H 36 D 50,4, 1 deep drawer tip-on opening, 1 side same colour as door	EBL75900
1	Hanging living base unit W 90 H 36 D 50,4, 1 deep drawer tip-on opening	EBL75900
1	Melamine worktop W 270 D 50,4 TH. 1,8 same colour as door	per lm TLE187
2	Wall unit fixing strip lm 2	08610501

LIVING KRW-6



ANTA
door

ROVERE GRIGIO
GESSATO
pinstripe grey oak

ELEMENTI A GIORNO
open units

GRIGIO PIOMBO
lead grey

STRUTTURA
carcass

LAVAGNA
slate grey

LIVING KRW-6

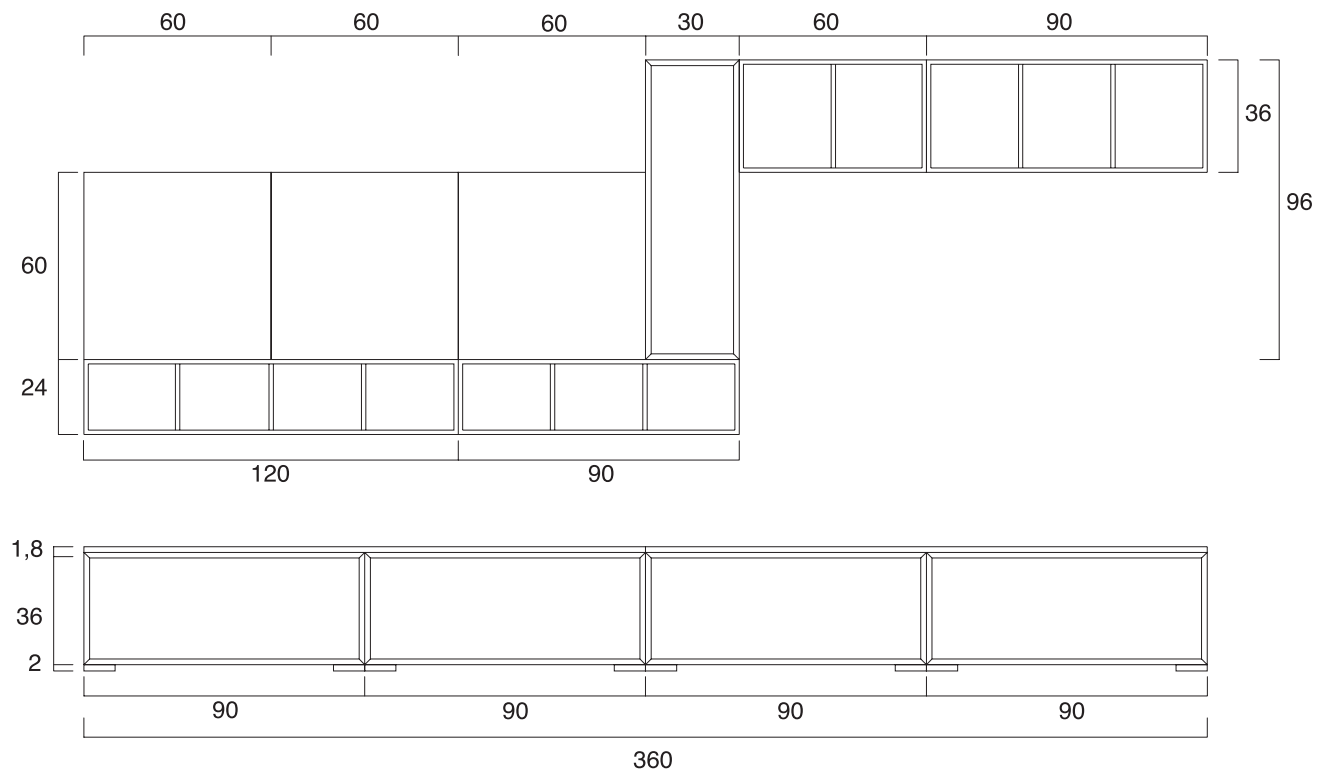

NR. ELEMENTI	DESCRIZIONE	CODICE
3	Pensile L 60 H 60 P 33,4, apertura push-pull	G2060601/2
1	Coprifianco H 60 P 31, laccato opaco	T98350
1	Pensile L 30 H 96 P 33,4, apertura push-pull, 2 fianchi come anta	E2020301/2
1	Elemento a giorno L 60 H 36 P 31, 2 vani, laccato opaco	E7701711
1	Elemento a giorno L 90 H 36 P 31, 3 vani, laccato opaco	E7701712
1	Elemento a giorno L 120 H 24 P 31, 4 vani, laccato opaco	E7701708
1	Elemento a giorno L 90 H 24 P 31, 3 vani, laccato opaco	E7701707
2	Base living L 90 H 38 P 50,4, 1 cestone apertura tip-on, 1 fianco come anta	EBL25900
2	Base living L 90 H 38 P 50,4, 1 cestone apertura tip-on	EBL25900
2	Top melaminico L 180 P 50,4 SP. 1,8 colore come anta	al ml TLE187
2	Asta appendipensili ml 2	08610501

No. of ELEMENTS	DESCRIPTION	CODE
3	Wall unit W 60 H 60 D 33,4, push-pull opening	G2060601/2
1	Matt lacquered side panel W 60 D 31	T98350
1	Wall unit W 30 H 96 D 33,4, push-pull opening, 2 sides same colour as door	E2020301/2
1	Matt lacquered open unit W 60 H 36 D 31, 2 compartments	E7701711
1	Matt lacquered open unit W 90 H 36 D 31, 3 compartments	E7701712
1	Matt lacquered open unit W 120 H 24 D 31, 4 compartments	E7701708
1	Matt lacquered open unit W 90 H 24 D 31, 3 compartments	E7701707
2	Hanging living base unit W 90 H 38 D 50,4, 1 deep drawer tip-on opening, 1 side same colour as door	EBL25900
2	Hanging living base unit W 90 H 38 D 50,4, 1 deep drawer tip-on opening	EBL25900
2	Melamine worktop W 180 D 50,4 TH. 1,8 same colour as door	per lm TLE187
2	Wall unit fixing strip lm 2	08610501

COMPOSIZIONE BASSA L 255 (con gola L 260)

LOW COMPOSITION W 255 (with finger rail W 260)



COMPOSIZIONE BASSA L 300 (con gola L 305)

LOW COMPOSITION W 300 (with finger rail W 305)



COMPOSIZIONE BASSA L 255 (con gola L 260)

LOW COMPOSITION W 255 (with finger rail W 260)

COMPONENTI COMPONENTS

Colonna 60 frigo-freezer 230 classe A+

60 cm column fridge-freezer 230 class "A+"

Base 45 2 cassetti e cestone

45 cm base unit with 2 drawers and deep drawer

Base 60 forno statico nero con ventilazione tangenziale di raffreddamento

static oven with orbital cooling ventilation 60 base unit

Piano cottura 60 4 gas inox con valvola di sicurezza

60 cm stainless steel hob with 4 gas burners with safety valve

Sottolavello 90

90 cm sink unit

Lavello ad incasso 86 x 50 1 vasca inox prelucidato

86x50 cm built-in sink with 1 stainless steel bowl

Pensile 45 H 72

45 cm wall unit H 72

Cappa 60 aspirante estraibile H 63 2 motori

60 cm hood slide-out ducting H 63 2 motors

Scolapiatti 90 H 72

90 cm plate rack H 72

Top 195 P 61 in laminato H 4

195 cm laminate worktop D 61 H 4

Asta appendipensili ml 2

2 lm wall unit fixing strip

(Elettrodomestici Indesit)
(Indesit appliances)

versioni REΣIND BRIDGE versions

MELAMINICO
LACCATO

versioni REΣIND NECK versions

MELAMINICO
LACCATO

COMPOSIZIONE BASSA L 300 (con gola L 305)

LOW COMPOSITION W 300 (with finger rail W 305)

COMPONENTI COMPONENTS

Colonna 60 frigo-freezer 230 classe A+

60 cm column fridge-freezer 230 class "A+"

Base 60 2 cassetti e cestone

60 cm base unit with 2 drawers and deep drawer

Base 60 forno statico nero con ventilazione tangenziale di raffreddamento

static oven with orbital cooling ventilation 60 base unit

Piano cottura 60 4 gas inox con valvola di sicurezza

60 cm stainless steel hob with 4 gas burners with safety valve

Base 60

60 cm base unit

Sottolavello 60

60 cm sink unit

Lavello ad incasso 86 x 50 1 vasca inox prelucidato

86x50 cm built-in sink with 1 stainless steel bowl

Pensile 60 H 72

60 cm wall unit H 72

Cappa 60 aspirante estraibile H 63 2 motori

60 cm hood slide-out ducting H 63 2 motors

Pensile 60 H 72

60 cm wall unit H 72

Scolapiatti 60 H 72

60 cm plate rack H 72

Top 240 P 61 in laminato H 4

240 cm laminate worktop D 61 H 4

Asta appendipensili ml 4

4 lm wall unit fixing strip

(Elettrodomestici Indesit)
(Indesit appliances)

versioni REΣIND BRIDGE versions

MELAMINICO
LACCATO

versioni REΣIND NECK versions

MELAMINICO
LACCATO

COMPOSIZIONE ALTA L 300 (con gola L 305)

HIGH COMPOSITION W 300 (with finger rail W 305)



COMPOSIZIONE BASSA L 360 (con gola L 365)

LOW COMPOSITION W 360 (with finger rail W 365)



COMPOSIZIONE ALTA L 300 (con gola L 305)

HIGH COMPOSITION W 300 (with finger rail W 305)

COMPONENTI COMPONENTS

Colonna 60 frigo-freezer 230 classe A+

60 cm column fridge-freezer 230 class "A+"

Base 60 2 cassetti e cestone

60 cm base unit with 2 drawers and deep drawer

Base 60 forno statico nero con ventilazione tangenziale di raffreddamento

static oven with orbital cooling ventilation 60 base unit

Piano cottura 60 4 gas inox con valvola di sicurezza

60 cm stainless steel hob with 4 gas burners with safety valve

Base 60

60 cm base unit

Sottolavello 60

60 cm sink unit

Lavello ad incasso 86 x 50 1 vasca inox prelucidato

86x50 cm built-in sink with 1 stainless steel bowl

Pensile 60 H 72

60 cm wall unit H 72

Cappa 60 aspirante estraibile H 63 2 motori

60 cm hood slide-out ducting H 63 2 motors

Pensile 60 H 96

60 cm wall unit H 96

Scolapiatti 60 H 96

60 cm plate rack H 96

Top 240 P 61 in laminato H 4

240 cm laminate worktop D 61 H 4

Mensola 120 P 31 sp. 3,8

120 cm shelf D 31 sp. 3,8

Asta appendipensili ml 4

4 lm wall unit fixing strip

(Elettrodomestici Indesit)
(Indesit appliances)

versioni REΣIND BRIDGE versions

MELAMINICO
LACCATO

versioni REΣIND NECK versions

MELAMINICO
LACCATO

COMPOSIZIONE BASSA L 360 (con gola L 365)

LOW COMPOSITION W 360 (with finger rail W 365)

COMPONENTI COMPONENTS

Colonna 60 frigo-freezer 230 classe A+

60 cm column fridge-freezer 230 class "A+"

Colonna 60 con cestone, forno statico nero con ventilazione tangenziale di raffreddamento

60 column with deep drawer configured for static oven with orbital cooling ventilation

Base 90 2 cassetti + cestone predisposto P.C.

90 cm base unit with 2 drawers + deep drawer configured for hob

Piano cottura 60 4 gas inox con valvola di sicurezza

60 cm stainless steel hob with 4 gas burners with safety valve

Base 60

60 cm base unit

Sottolavello 90

90 cm sink unit

Lavello ad incasso 86 x 50 1 vasca inox prelucidato

86x50 cm built-in sink with 1 stainless steel bowl

Pensile 60 H 72

60 cm wall unit H 72

Cappa 90 sempione acciaio inox satinato + vetro

90 cm sempione hood brushed stainless steel + glass

Pensile 60 H 72

60 cm wall unit H 72

Scolapiatti 90 H 72

90 cm plate rack H 72

Top 240 P 61 in laminato H 4

240 cm laminate worktop D 61 H 4

Top 60 P 61 in laminato H 4

60 cm laminate worktop D 61 H 4

Asta appendipensili ml 4

4 lm wall unit fixing strip

(Elettrodomestici Indesit)
(Indesit appliances)

versioni REΣIND BRIDGE versions

MELAMINICO
LACCATO

versioni REΣIND NECK versions

MELAMINICO
LACCATO